

Instrumente

Medical Instruments



Inhalt **Content**

Instrumente / Medical Instruments

INSTRUMENTE / INSTRUMENTS

Vorwort / Preface

Inhaltsverzeichnis / List of contents

1	Reflektoren Reflectors	11	Kiefer Antrum
2	Otologie Otology	12	Hirn Brain
3	Rhinologie Rhinology	13	Wirbelsäule Spine
4	Hypophyse Hypophysis	14	Allgemeines Instrumentarium General Instruments
5	Nasennebenhöhlen Nasal sinuses	15	Broncho-Ösophaguskopie Bronchooesophagoscopy
6	Adenotomie Adenotomy	16	Anästhesie Anaesthesia
7	Tonsillektomie Tonsillectomy	17	Elektrochirurgie Electrosurgery
8	Mikro-Laryngoskopie Micro-Laryngoscopy	18	Instrumenten-Sets Instrument-Sets
9	Tracheotomie Tracheotomy	19	Behälter Container
10	Mund-Kehlkopf Mouth-Larynx	20	Sonstiges Miscellaneous

INSTRUMENTENKATALOG
INSTRUMENTS - CATALOGUE



Gemeinsam
in die
Zukunft.

Together
into the
future.

Unser
Angebot an
Spezial-
Instrumenten
für Sie.

Our
offer of spezial
instruments
for you.

INSTRUMENTENKATALOG INSTRUMENTS - CATALOGUE



HEIMOMED Kerpen

HEIMOMED Medizintechnik hat sich seit der Gründung 1970 als Heinze & Moritz GmbH zu einem bedeutenden mittelständischen Unternehmen in der Instrumenten-Technik entwickelt, und ist ein anerkanntes Segment im Kreislauf von Diagnose, Therapie und Rehabilitation geworden. Um unsere intensive Kundenberatung sicherzustellen, haben wir unseren Verkaufsaufendienst in den vergangenen Jahren erheblich ausgeweitet. Für den Endverbraucher unserer Artikel bedeutet dies, immer einen zuverlässigen und qualifizierten Ansprechpartner in seiner Nähe zu haben. Aus diesem Grunde können wir auch einen Notdienst rund um die Uhr anbieten.

Wichtigste Vorstufe zum Verkauf von Instrumenten ist deren Herstellung. Hier hat HEIMOMED Medizintechnik einen sehr hohen Standard erreicht. Für uns arbeiten nur spezialisierte, gut ausgebildete Chirurgiemechaniker, die aus hochwertigen Chirurgiestählen (nach DIN) mit modernsten Werkzeugen unsere Instrumente "Made in Germany" herstellen. (Laserschweißnähte, Untergashärtung, hochwertige Hartmetalleinlagen für Standard- und Mikro-Instrumente sind nur einige Stichworte). Diese hohen Ansprüche an die Qualität sind kein Selbstzweck sondern erhöhen die Nutzungsdauer der Instrumente und damit die Folgekosten für die Klinik oder die Praxis. Anschließend intensive Qualitätskontrollen durch unsere QM-Abteilung sichern die gleichbleibenden Eigenschaften unserer Instrumente und ermöglichen es uns, drei Jahre Garantie zu gewähren. Seit Mai 1999 werden unsere Instrumente mit einem eigenen Laser signiert. Das bedeutet für den Anwender lange Haltbarkeit der Signatur, gute Erkennbarkeit und die Möglichkeit, individuelle Signaturen auf die Instrumente aufzubringen.

Since its foundation in 1970 as Heinze & Moritz GmbH, HEIMOMED Medizintechnik has developed into a significant medium-sized enterprise in the field of instrument technology. The company has become a recognised player in the field of diagnosis, therapy and rehabilitation. In order to expand our customer service we have considerably increased the number of our sales advisors in the last few years. The result is that the end-users of our products always have at their disposal a reliable and qualified contact person nearby, offering in Germany a 24-hour on-call service.



HEIMOMED Greussen

The manufacture of the instrument is the most important first step towards its sale; here HEIMOMED has reached a very high standard. Only specialised, well-trained surgical engineers manufacture our „Made in Germany“ instruments, using high-grade DIN-conforming steel and state-of-the-art tools. (Laser-welded joints, gas-pressure tempering, top-grade metal inlay for standard and micro instruments are just a few examples.) These high demands for quality have a purpose in increasing the lifetime of the instruments and reducing the subsequent costs for hospitals and practices. Moreover, intensive quality controls by our quality management department ensure the characteristics of our instruments remain constant, enabling us to grant a 3-year guarantee. Since May 1999 our instruments have been signature-branded using our own laser device. For the user this means longer durability of the signature, better recognition and the possibility of furnishing the instruments with individual signatures.

INSTRUMENTENKATALOG INSTRUMENTS - CATALOGUE



Neben der Herstellung und Lieferung von chirurgischen Instrumenten, Artikeln und Zubehör für diverse operative und medizinische Spezialgebiete, ist unsere wichtigste Zielsetzung, unseren Kunden mit individueller Beratung und professionellem Service zur Seite zu stehen. Das gelingt nur dadurch, daß Herstellung und Vertrieb in einer Hand sind. Für den Anwender heißt das eingehende Beratung und Betreuung vor, während und nach dem Kauf.

Wir wünschen uns langfristige Kundenverbindungen und richten unser Handeln danach. Wir behaupten uns in dieser, für die Leistungserbringer im Gesundheitswesen schwierigen Zeit, "nicht durch Sonderangebote", sondern durch wirklich preiswerte Qualität und gleichbleibend guten Service.

Natürlich muss ein Instrument, das sich im täglichen Einsatz befindet, auch einmal repariert oder überarbeitet werden. Hier hilft Ihnen unsere Reparatur-Service-Abteilung schnell und zuverlässig weiter.

Die Erfüllung der gesetzlichen Anforderungen, für uns schon immer eine Selbstverständlichkeit, wurde durch die Zertifizierung nach ISO 9001 bestätigt und zeigt unsere permanente Verpflichtung zur Sicherstellung eines optimalen Qualitätsstandards für unsere Produkte und Leistungen auch in Zukunft. Von selbst versteht sich, daß alle unsere Medizinprodukte mit dem CE-Kennzeichen gekennzeichnet sind.

In addition to the manufacture and supply of surgical instruments, items and accessories for diverse operative and medical specialties, our prime objective is to offer to our customers supportive individual customer advice and professional service. Our key to success here is that manufacture and supply are under one roof. For our customers this means intensive advice before, during and after the purchase of the products.

We wish to have a long-term business relationship with our customers and focus our attentions accordingly. In these difficult days for suppliers in the health care sector our claim to good service is not via 'special offers' but by offering really affordable quality and consistently good service.



Naturally, any instrument in daily use must be able to be repaired or re-worked. Here our service department is there to help you quickly and dependably.

Fulfilling legal requirements is something we have always regarded as a matter of course. With ISO 9001 certification this is now officially confirmed, showing our permanent responsibility to guarantee an optimal quality standard for our items and services now and in the future. Needless to say, all our medical products are CE-marked.

INSTRUMENTENKATALOG INSTRUMENTS - CATALOGUE

Mit diesem neuen, überarbeiteten Instrumenten-Katalog, der Ihnen eine Übersicht über unser Lieferprogramm bietet, möchten wir diesen hohen Anspruch auch optisch unterstreichen. Mit Hilfe der Unterteilung in die verschiedenen Sparten sowie des übersichtlichen Inhaltsverzeichnisses, das nach Artikelbezeichnung, Artikelnummern und Autoren gegliedert ist, finden Sie den gewünschten Artikel schnell und zuverlässig. Den Anforderungen des europäischen Marktes folgend erscheint dieser Katalog in Deutsch und Englisch.

Sollten Sie ein Produkt vermissen, eine Sonderanfertigung wünschen oder Fragen haben, helfen Ihnen unsere Medizinprodukteberater im Innen- und Außendienst gerne weiter.

**Produktänderungen behalten wir uns vor.
Für die Druckfehler übernehmen wir keine Haftung.**

This new, revised instrument catalogue, which offers you an overview of our product range, also emphasises our commitment to high standards. The subdivision into different sections and easily-viewable index of contents by product description, product number and creator, enable you to locate your desired items quickly and reliably. To address the demands of customers in other European markets we have produced the catalogue in English in addition to German.

If you cannot find a particular product, wish to order a special model or have any questions, please contact our HEIMOMED advisors who will be glad to assist you.

Instruments are subject to change.
We must not be held liable for printer's error.



HEIMOMED Heinze GmbH & Co. KG
Medizintechnik
Daimlerstrasse 30
D-50170 Kerpen
Tel.: +49 2273 9849 - 0
Fax: +49 2273 9849 - 25

HEIMOMED Heinze GmbH & Co. KG
Medizintechnik
Greußener Strasse 22
D-99718 Greußen
Tel.: +49 3636 7623 - 0
Fax: +49 3636 7623 - 23

HEIMOMED Heinze GmbH & Co. KG
Medizintechnik
Ardaggerstrasse 41
A-3300 Amstetten
Tel: +43 7472 6659 - 5
Fax: +43 7472 6659 - 6

A

Absaugkatheter	5-8
Abzefzange	7-16
Abziehstein	2-30
Accu-Box	1-8
Adeno-Conchoton	6-5
Adeno-Conchoton Nasenrachenzange	6-5
Adenotom	6-2
Adson	2-13, 3-2, 3-3
Adson Pinzette	2-13, 3-2, 3-3
Adson-Brown	3-3
Adson-Brown Pinzette	3-3
Adson-Griffe	3-3
ADLATUS Kaltlichtprojektor	1-6
Äzmittelsonde	3-18
Äzmittelträger	3-18
Anatomische Pinzetten	14-3, 14-4
Aneurysmen-Clips	12-19, 12-20, 12-21, 12-22, 12-23, 12-24 12-25, 12-26, 12-27, 12-28, 12-29, 12-30, 12-31, 12-32 12-33, 12-34, 12-35, 12-36, 12-37, 12-38, 12-39, 12-40
Aneurysmen-Clips mini	12-37, 12-38, 12-39, 12-40
Aneurysmen-Clips TITAN	12-19, 12-20, 12-21, 12-22, 12-23, 12-24 12-25, 12-26, 12-27, 12-28, 12-31, 12-32 12-33, 12-34, 12-35, 12-36
Aneurysmen-Clips TITAN mini	12-37, 12-38, 12-39, 12-40
Anlegepinzetten	12-49, 12-50
Anlegezangen	12-41, 12-42, 12-43, 12-44, 12-45, 12-46
Anlegezangen TITAN	12-41, 12-42, 12-43, 12-44, 12-45, 12-46
Anschlusskabel	17-1, 17-4
Anthony Fischer	5-16
Anthony Fischer Antrumkatheter	5-16
Antrumkatheter	5-16
Antrum-Kurette	5-6, 5-19
Antrum-Löffel	5-6, 5-19
Antrum-Saugstanze	5-22
Antrumstanze	5-21, 5-22
Approximatoren	12-48
Asch	3-48
Asch Nasenrichtzange	3-48
Atraumatische Gefäßclips	12-49
Atraumatische Pinzette	3-4
Atikus-Stanze	5-18
Aufricht	3-40, 3-44
Aufricht Nasenflügelhaken	3-40
Aufricht Nasenhaken	3-40
Aufricht Nasenraspel	3-44
Aufslecksauger	2-27, 2-28

B

Backhaus Tuchklemmen	3-14
Ballenger	3-35
Ballenger Schwingmesser	3-35
Baracani	10-5
Barany Lämröhrchen	2-2
Barnes Saugrohr	2-28
Baron Saugrohr	2-28
Barraquer	2-21, 12-13, 12-14
Barraquer Nadelhalter	2-21, 12-13, 12-14
Beckmann	3-19, 6-1
Beckmann Nasenspekula	3-19
Beckmann Ringmesser	6-1
Bellucci	2-17, 2-32
Bellucci Ohrschere	2-32
Bellucci Wundspreizer	2-17
Belocq	3-50
Belocq Nasen-Röhrchen	3-50
Berger	2-35
Beyer	2-8, 2-25, 5-18, 13-11, 13-12, 14-30, 14-31

Beyer Atikus-Stanze	5-18
Beyer Hohlmeißelzangen	2-25, 13-11, 13-12, 14-30, 14-31
Beyer Kieferhöhlenzange	5-18
Beyer Paracentesenadel	2-8
Biemer	12-7, 12-47, 12-48, 12-50
Biemer Approximator	12-48
Biemer-Müller	12-48
Billeau Ohrschlingen	2-9
Bipolare Pinzetten	17-6, 17-7, 17-8, 17-9, 17-10, 17-11
Blakesley	3-28, 3-29, 3-30, 4-9, 5-10, 5-12, 5-13 5-14, 5-21, 5-22, 10-3, 12-59, 13-6
Blakesley Biopsiezange	5-22
Blakesley durchschneidend	3-30, 5-14
Blakesley Kehlkopfzange	10-3
Blakesley mit Absaugung	3-29, 3-30, 5-10, 5-13
Blakesley Nasenzange	3-28, 3-29, 5-12, 5-23
Blakesley PE-Zange	5-10
Blätter	13-1, 13-2, 13-4
Blätter für Wundspreizer	13-4
Blätter für Wundspreizer TITAN	13-4
Blätter Gegensperner	13-1, 13-2
Blätter-Wechselpinzette	13-3
Blessing Nystagmusbrille	2-6
Blöhmke	7-9
Blöhmke Tonsillenfaßzange	7-9
Blutstill - Meißel	2-22
Boettcher	7-11
Boettcher Tonsillenschere	7-11
Böhler Hohlmeißelzangen	13-10, 14-29
Bohrer	2-39
Bohrer für Distractionsschrauben	13-7
Bohrerhandstück	2-38
Bohrerstände	2-41
Bohrlehre	13-6
Bohrsysteme	2-37
Boies	3-49
Boies Nasenricht-Elevatorium	3-49
Bougie	5-1, 5-2
Bowmann Sonde	7-7
Bratsche Sonden	12-1
Brawley	5-3
Brawley Kieferhöhlenraspel	5-3
Brillina Optik	5-8, 5-9
Broncho-Ösophagoskopiezangen	15-1, 15-2
Brünings	2-4, 2-22, 2-26, 3-26, 3-35 7-8, 7-15, 10-1, 10-4, 10-5
Brünings Ohrlupe	2-4
Brünings Flachmeißel	2-22
Brünings Griff	10-4
Brünings Hohlmeißel	2-22
Brünings Knochenstanze	2-26
Brünings Mundspatel	10-1
Brünings Nasenzange	3-26
Brünings Septummesser	3-35
Brünings Tonsillenschere	7-8
Brünings Tonsillenschnürer	7-15
Brünings Zungenspatel	10-1
Brünings-Brunk	5-3
Brünings-Brunk Kieferhöhlenhaken	5-3
Bruststütze	7-1, 8-2
Buck Ohrkürbchen	2-11
Buckingham Paukenspiegel	2-30
Bürste f. Bohrer	2-41
Buldogklemmen	12-51, 12-52, 14-20, 14-21

C

Caplan	3-25
Caplan Schere	3-25
Caspar Distraktor	13-6



Inhalt Instrumentenkatalog 09-0010-00 H

Caspar Gegensperer	13-1, 13-2	De Bakey atraumatische Pinzette	3-4
Caspar Rongeure	12-57	De Bakey Nadelhalter	3-16, 14-27
Caspar Wirbelkörper	13-1, 13-2, 13-6	De Vibiss Schädelzange	12-2
Caspar Wundspreizer	13-3, 13-5	Dean	7-11
Calgutschlingen für Roederbinder	7-16	Dean Tonsillenschere	7-11
Cerumenhäkchen	2-9	Derf	2-21, 3-15, 14-27
CHIROPPO 980	2-37	Derf Nadelhalter	2-21, 3-15, 14-27
Chirurgische Pinzetten	3-3, 7-9, 14-3	Diamantbohrer	2-39
Chirurgische Scheren	3-9	Dieter	2-32
Choanerhaken	3-18, 3-43	Dieter Hammerkopfstanze	2-32
Chonchoton	9-4	Diethrich	14-10, 14-11
Citelli	2-26, 5-18	Dilatator	7-7
Citelli Knochenstanze	2-26, 5-18	Dingmann	3-49, 7-2
Claus-Eicken	7-18	Dingmann Nasenricht-Elevatorium	3-49
Claus-Eicken Umstechungsnadeln	7-18	Dissektoren	2-31, (2-3, 14-34
Clip-Programm	12-18	Distractions-Schrauben	13-7
Clyso	5-2	Distraktor	13-6
Coakley	5-4	Doppel-Kürette	5-4
Coakley Doppel-Kürette	5-4	Doppelevatorium	3-32
Coakley Kielerhöhlen - Kürette	5-4	Doppelgelenk f. Stimmreflektor	1-1
Collin	16-5	Doppelhaken	3-42
Collin Zungenzange	16-5	Doppellöffel	2-29
Columellaklemme	3-4	Doppellöffel-PE-Zange	5-10
Colver	7-8, 7-9	Doppellöffelzange	5-17, 5-20, 8-4
Colver Tonsillenfaßzange	7-9	Doyen	3-36
Colver Tonsillensmesser	7-8	Doyen Raspatorium	3-36
Cordes	10-5	Drahtschere	3-43
Corwin	7-17	Drahtschließzangchen	2-36
Corwin Tonsillenkompessorium	7-17	Drahtschlingen	3-43
Cottle	3-4, 3-10, 3-21, 3-32, 3-37, 3-38 3-40, 3-41, 3-42, 3-44, 3-49, 4-7	Drahtschlingenelektrode	17-2
Cottle Columellaklemme	3-4	Drillbohrer	12-60
Cottle Elevatorium	3-32	Duehnssen	7-9
Cottle Fixierpinzette	3-4	Dupuy	7-18
Cottle Hammer	3-37, 4-7	Dupuy Umstechungsnadeln	7-18
Cottle Hauthäkchen	3-40	Duraschutzzange	12-60
Cottle Knorpelquetscher	3-49	Duraspreizer	2-18
Cottle Meißel	3-38, 4-7		
Cottle Nasenflügelhaken	3-41	E	
Cottle Nasenraspel	3-44	Echlin Hohlmeißelzangen	13-13, 14-32
Cottle Nasenspekula	3-21	Eicken	5-1, 10-5
Cottle Pinzette zur Insertion	3-4	Eicken Spülrohr	5-1
Cottle Raspatorium	3-32	Eicken Spülkanüle	5-1
Cottle Schere	3-10	Einführungsinstrument für Paukenröhrchen	2-34
Cottle-Kazanjian	3-25	Einführungszange für Paukenröhrchen	2-34
Cottle-Kazanjian Knorpelschere	3-25	Einsetz-Instrument für T-Paukenröhrchen	2-33
Cottle-Neuert	3-41	Einweg-Markierer	3-48
Cottle-Neuert Nasenflügelhaken	3-41	Einweg-Skalpell	2-12, 3-1
Cottle-Walsham	3-48	Einweg-Skalpellklingen	2-12, 3-1, 14-1
Cottle-Walsham Nasenrichtzange	3-48	Elektrodenhandgriff	17-1
Craig	3-26	Elevatorium	2-23, 2-24, 3-32, 3-33, 3-34, 3-36, 7-15
Craig Nasenzange	3-26	Epistaxiskatheter	3-50
Crile	2-21, 14-27	Ersatz-Bimchen f. Stimlampe	1-4
Crile-Wood	3-15, 14-27	Ersatzbirne für ADLATUS Kaltlichtprojektor	1-6
Crile-Wood Nadelhalter	3-15, 14-27	Ersatzbirne Laryng.-Griff	16-1, 16-2
Cruratomieschere	2-33	Eves	7-15
Cushing	12-53, 12-57, 14-2, 14-25	Eves Tonsillenschnürer	7-15
Cushing Rongeure	12-57		
Cushing-Landolt Spekula	4-5		
		F	
D		Fadenfänger	3-50
Dahlgren	12-2	Fadengabel	7-19
Dahlgren Schädelzange	12-2	Fadenhäkchen	7-19
Davis	12-3, 14-34	Fadenklemme	12-49
Davis-Boyle Mundsperrer	7-2	Fadenschere	2-14
Davis-Meyer Zungenspatel	7-3	Fahlbusch	4-8
De Bakey	3-4, 3-16, 12-16, 12-51 12-52, 14-20, 14-21, 14-27	Falk	7-18
		Falk Umstechungsnadeln	7-18



Inhalt Instrumentenkatalog 09-0010-00 H

Hartmann-Halle	3-20
Hartmann-Halle Nasenspekulum	3-20
Haslinger	6-4
Haslinger Gaumensegelhalter	6-4
Hauthäkchen	3-40, 3-42
Heddrich	5-3, 10-1
Heddrich Lippenhalter	5-3, 10-1
Heermann	2-29, 2-36
Heermann Hammer	2-36
Heermann Meißel	2-36
Heermann Meißelgriff	2-36
Heermann Mikro-Instrumente	2-29
Heifetz	12-4, 12-54
Heister	16-5
Heister Mundsperrer	16-5
Henke	7-14, 7-15
Henke Tonsillenelevatorium	7-14, 7-15
Herberhold Zungenspatel	7-3
Herzfeld	7-16
Herzfeld Gaumenhaken	7-16
Heymann	3-5
Heymann - Schere	3-5
Hirrspatel	12-53, 12-54
HM Bohrer	2-39
HNO Arbeitsplätze	20-5
HNO-Set im Elui	1-7
Hörtests	20-4
Hofer	6-2
Hofer Gaumenbogenhaken	6-2
Hohlmeißel	2-22
Hohlmeißelzangen	2-25, 13-10, 13-11, 13-12, 13-13 13-14, 14-29, 14-30, 14-31, 14-32, 14-33
Höltinger	8-2
Höltinger Laryngoskop	8-2
Holmgren	2-3
Holmgren Ohrtrichter	2-3
Hopmann	6-3
Hopmann Velotraktor	6-3
Hörschlauch	2-2
House	2-17, 2-29, 2-32, 3-42
House Doppelhaken	3-42
House Löffel	2-29
House Mikro-Instrumente	2-29
House Ohrzängchen	2-29
House Quetschzange	2-17
Huber Universalgriff	10-4
Hurd	7-14, 7-18
Hurd Tonsillenelevatorium	7-14
Hurd Umstechungsnadeln	7-18
Hypophysektomie Instrumente	4-5, 4-6
Hypophyseschere	4-6
Hypophysenzange	4-3, 4-9, 12-56

I

Imper-Mikrobohrer	2-42
Inhalierplätze	20-4
Injektionskanüle	8-1
Instrumente für Paukenröhrchen	2-33, 2-34
Instrumente mit Achtkant-Griff	2-29
Instrumente mit Zeigriff	8-3, 8-4
Instrumente zur Mikro-Laryngoskopie	8-3, 8-4, 8-5
Instrumentenschale	19-2
Instrumententray	20-2
Intubationsrohr	9-2
Irrigationseinheit	2-37

J

Jackson	8-2
Jackson Laryngoskop	8-2
Jacobson	12-7
Jaentsch	7-7
Jaentsch Sialographie	7-7
Jansen	2-2, 2-23, 3-2, 13-12, 14-31
Jansen Hohlmeißelzangen	13-12, 14-31
Jansen Hörschlauch	2-2
Jansen Pinzette	3-2
Jansen Raspatorium	2-23
Jatho	6-5
Jatho Nasenrachenzange	6-5
Joseph	2-15, 3-5, 3-33, 3-35, 3-40, 3-42, 3-44
Joseph Hauthäkchen	3-40
Joseph Nasenhaken	3-42
Joseph Nasenraspel	3-44
Joseph Nasensägen	3-44
Joseph Plastikmesser	3-35
Joseph Raspatorium	3-33
Joseph-Masing	3-32
Joseph-Masing Raspatorium	3-32
Joseph Schere	2-15, 3-5
Juracz	6-3
Juracz Nasenrachenzange	6-3

K

Kabel bipolar	8-7
Kabienske Pulverbläser	2-2, 10-6
Kaltlicht-Stimlampe	1-5
Kaltlichtprojektor	1-6
Kanülen	3-11, 7-7, 8-6, 14-2
Kasten zur Geruchs- und Geschmacksprüfung	20-2
Kathetereinführzangen	16-6
Kehlkopfhalter	10-6
Kehlkopfsätze	10-5
Kehlkopftrohe	7-7, 10-4, 10-6
Kehlkopfspiegel	10-2
Kehlkopfsprayer	10-8
Kehlkopfspritze	7-7, 10-6
Kehlkopfwattenträger	10-7
Kehlkopfzange	10-3, 10-4
Keilbeinstanze	5-18
Kelly	3-13
Kelly Gefäßklemme	3-13
Kerrison	2-26, 5-7, 12-58, 13-9
Kerrison Kieferhöhlenstanze	5-7
Kerrison Knochenstanze	2-26
Kerrison Stanze	12-58, 13-9
Kerrison-Jacoby	12-58
Kieferhöhlenbohrer	5-4
Kieferhöhlenmeißel	5-3
Kieferhöhlenhaken	5-3
Kieferhöhlenraspel	5-3
Kieferhöhlenstanzen	5-7, 5-18
Kieferhöhlenzange	5-18
Kieferhöhlen-Faßzange	5-20
Kieferhöhlen-Sonde	5-6
Killian	3-34, 5-2, 9-2, 3-21, 3-32, 3-39, 5-2, 10-7
Killian Elevatorium	3-32, 3-34
Killian Meißel	3-39
Killian Nasenspekula	3-21
Killian Sonde	5-2
Killian Spürohr	5-2
Killian Trachealspekulum	9-2
Killian-Claus	3-39
Killian-Struycken Nasenspekula	3-21

Kilner	2-15, 3-5, 3-40, 7-4	Langenbeck Wundhaken	5-3, 14-24
Kilner - Schere	2-15, 3-5	Lärntrommel	2-2
Kilner Nasenflügelhaken	3-40	Laryngofissurschere	9-2
Kilner Nasenhäkchen	3-40	Laryngoskop	8-1, 8-2, 16-1, 16-2, 16-3, 16-4
Kilner Zungenspatel	7-4	Laryngoskop-Griff	16-1, 16-2
Kilner-Doughly Mundsperrer	7-1	Larynx-Tastelektrode	8-7
Kley	2-30	Lasersignierung	20-1
Kley Fußplattenmesser	2-30	Leksell Hohlmeißelzangen	13-13, 14-32
Klingen	7-8, 14-1	Lemper	2-24, 2-25, 13-12, 14-31
Klingenhalter	2-12, 3-1, 7-8, 14-1	Lemper Hohlmeißelzangen	2-25, 13-12, 14-31
Knochenhaltezange	3-47	Lemper Raspatorium	2-24
Knochenmehrsammler	2-41	Lerche	2-20
Knochenstanzen	2-26, 5-18	Lexer	3-7, 14-9
Knochenzangen	12-58, 13-9	Lexer Schere	3-7, 14-9
Knopfkanülen	7-7, 14-2	Lichtenberg	3-16
Knorpelquetscher	3-49	Lichtenberg Nadelhalter	3-16
Knorpelscheren	3-25	Lichtquelle 6 Volt	1-8
Knorpelzange	3-25	Lichtquelle für die Nystagmusbrille	1-8
Knüppelzangen	12-10	Lichtträger	8-1
Koagulationsrohr	8-7, 17-4	Lichtwitz	5-1
Kocher	7-12, 9-4	Lichtwitz Spülkanüle	5-1
Kocher Führungssonde	9-4	Lichtwitz Trokar	5-1
Kocher Tonsillenklemme	7-12	Lilie	7-11
Kölnner Sparkammer	12-55	Lilie Tonsillenschere	7-11
König	16-5	Lindemann Fräser	2-40
Kopfhautklammer	12-55	Lippenhalter	5-3, 10-1
Korbpatel	6-2	Lister Schere	3-9
Kornzangen	3-14	Littauer	2-7
Kratz	6-1	Littauer Ohrtamponadenzange	2-7
Kratz Ringmesser	6-1	Löbker	9-1
Krause	2-7, 3-43, 10-5	Löbker Faßzange	9-1
Krause Nasenpolypenschnürer	3-43	Loch	7-15
Krause Ohrpolypenschnürer	2-7	Loch Tonsillenelevatorium	7-15
Krause-Voss	2-7, 3-43	Locklin	14-5, 14-13
Krause-Voss Nasenpolypenschnürer	3-43	Löffel	2-35, 5-6, 5-19
Krause-Voss Ohrpolypenschnürer	2-7	Lösungsschalen	19-1
Kreissägen	2-42	Lopez-Reinke	7-14
Kressner	3-25	Love-Gruenwald Rongeurs	12-57
Kressner Muschelquetschzange	3-25	Lubet-Barbon	3-17
Küretten	5-4, 5-5, 5-6	Lubet-Barbon Nasentamponadenzange	3-17
Kugelelektrode	17-2, 17-3	Lubrfluid 500	2-41
Kuhlendahl	12-3, 14-31, 14-34	Lucas	2-8, 2-9, 2-13, 3-2, 14-4
Kuhlendahl Dissektor	12-3	Lucas Pinzette	2-13, 3-2
Kuhlendahl Hohlmeißelzangen	13-12, 14-31	Lucas Cerumenhäkchen	2-9
Kunststoffband f. Stirnreflektor	1-1, 1-2	Lucas Paracentesenadel	2-8
Kupplungskopf	3-23	Luer	3-42, 13-10, 14-29
		Luer Doppelhaken	3-42
		Luer Hohlmeißelzangen	13-10, 14-29
		Luer-Lock Anschluß	5-2
		Lupenbrille	1-7
L		M	
La Borda	9-1	Magill	16-6
La Borda Tracheostomaspreizer	9-1	Magill Katheterinführzangen	16-6
La Force	6-2	Maier Kornzangen	3-14
La Force Adenotom	6-2	Maltz	3-45, 3-46
Lahey	9-1	Maltz Nasenraspel	3-45, 3-46
Lahey Faßzange	9-1	Marschik	7-9
Landoit	4-6, 12-56	Marschik Tonsillenpinzetten	7-9
Landoit Pinzette	4-6	Masing	3-32, 3-35, 3-36, 3-41, 3-46, 3-50
Landoit Spreizzange	4-6	Masing Elevatorium	3-32
Lange	3-18, 3-43, 10-5	Masing Meißel	3-39
Lange Ätzmittelträger	3-18	Masing Nasenflügelhaken	3-41
Lange Choanahaken	3-18	Masing Nasenrachenluftröhre	3-50
Lange Nasenpolypenschnürer	3-43	Masing Nasenraspel	3-46
Lange-Wilde Ohrpolypenschnürer	2-7	Masing Ritzmesser	3-35
Langenbeck	2-11, 3-36, 3-47, 5-3, 14-24	Mathieu	2-21, 3-16, 14-28
Langenbeck Elevatorium	3-36	Mathieu Nadelhalter	2-21, 3-16, 14-28
Langenbeck Kielerhöhlenhaken	5-3		
Langenbeck Knochenhaltezange	3-47		
Langenbeck Ohrschlinge	2-11		
Langenbeck Raspatorium	3-36		

Inhalt Instrumentenkatalog 09-0010-00 H

Mayo-Hegar	3-15	Muck Nasensaugglas	5-2
Mayo-Hegar Nadelhalter	3-15	Muck Periostmesser	2-24
MC-Laryngoskopieinstrumente	8-5	Muck Tonsillenschere	7-11
McIvor Mundsperrer	7-1	Müller	12-48, 12-49
McGee	2-36	Mundspatel	10-1
McGee Drahtschließzangen	2-36	Mundsperrer	7-1, 7-2, 16-5
McIndoe	3-38	Muschelquetschzangen	2-17, 3-25, 3-47
McIndoe Meißel	3-38	Myles	3-31, 5-15
McIntosh	16-1, 16-2, 16-3	Myles Nasenzange	3-31, 5-15
McIntosh Laryngoskop	16-1, 16-2, 16-3		
McKenty	3-32	N	
McKenty Doppelevatorium	3-32	Nadel Dosen	19-1
McKenty Elevatorium	3-32	Nadelelektrode	17-2, 17-3, 17-4, 17-5
McKenty Raspatorium	3-32	Nadelhalter	2-21, 3-15, 3-16, 12-9, 12-13, 12-14, 12-15, 14-27, 14-28, 14-36
Medizinbecher	19-2	Nadelhalter Cife	2-21
Mehdom	12-47, 12-50	Nadelhalter Derf	2-21, 14-47
Meißel	4-7, 2-22, 2-36, 3-38, 3-39	Nadelhalter Mathieu	2-21
Meißelgriff	2-36	Nadelhalter Mikro-Ryder	2-21
Meßbecher	19-2	Nadelhalter Neivert	2-21
Messer	3-35	Nadeln	2-29
Messenelektrode	17-2	Nager	6-2, 7-16, 7-19
Meßlineal	3-48	Nager Gaumenhaken	6-2, 7-16
Messzylinder	2-31	Nager Umstechungsnadel	7-19
Metallfuß für Zerstäuber	2-1	Nasenflügelhaken	3-40, 8-41
Metalllineal	3-48	Nasenhaken	3-42
Metzenbaum	3-8, 7-11, 14-6, 14-7, 14-8, 14-14, 14-15, 14-16, 14-17, 14-18, 14-19	Nasennebenhöhle	3-27, 3-28, 5-12
Metzenbaum Schere	3-8, 14-6, 14-7, 14-8, 14-14, 14-15, 14-16, 14-17, 14-18, 14-19	Nasenpolypenschnür	3-43
Metzenbaum Schere SUPERCUT	14-18, 14-19	Nasennachentubus	3-50
Metzenbaum Tonsillenschere	7-11	Nasennachenzangen	6-3, 6-4, 6-5
Michel	5-11	Nasenraspel	3-44, 3-45, 3-46
Michel Postrhinoskopie Spiegel	5-11	Nasenricht-Elevatorium	3-49
Micro-Messer	2-31	Nasenrichtzange	3-48
Microlein-Pinzette	2-13	Nasensägen	3-44
Middleton-Jansen Nasenzangen	3-26	Nasensauger	3-24
Mikrobohrer	2-42	Nasensaugglas	5-2
Mikrosägen	2-38	Nasenschere	5-17
Mikroskope	20-6, 20-7	Nasensonde	3-50
Mikrowellentherapiegeräte	20-4	Nasenspekula	3-19, 3-20, 3-21, 3-22
Mikro-Bohrsystem	2-37, 2-38	Nasenspiegel	3-49
Mikro-Federschere	12-7, 12-8, 12-12, 14-35	Nasentamponadenzangen	3-17
Mikro-Handstücke	2-38	Nasensatteltträger	6-4
Mikro-Instrumente	2-29, 2-31	Nasenzange durchschneidend	5-21, 5-22
Mikro-Klingen	3-35	Nasenzangen	3-26, 3-27, 3-28, 3-30, 3-31, 5-12, 5-13, 5-14, 5-15, 5-16, 5-21, 5-22, 6-3
Mikro-Klingenhalter	3-35	Nasen-Röhrchen	3-50
Mikro-Krüppelzangen	12-10	Negus	6-1, 7-1, 7-13
Mikro-Molzeinheit	2-37	Negus Tonsillenklemme	7-13
Mikro-Nadelhalter	12-9, 12-13, 12-14, 12-15, 14-36	Neivert	2-21
Mikro-Nadelhalter TITAN	12-15	Neurektomieschere	2-32
Mikro-Ohrscherchen	2-34	Nicola	4-8
Mikro-Pinzetten	12-6, 12-11, 12-16	Nierenschalen	19-2
Mikro-Pinzetten TITAN	12-11, 12-16	Notfallkoffer	20-4
Mikro-Präparierscheren	12-8	Nußbaum Raspatorium	3-33
Mikro-Ringkurette	4-1, 4-2, 4-3	Nystagmusbrille	2-6
Mikro-Ringpinzetten	12-17		
Mikro-Ryder	2-21, 3-16, 14-27		
Mikro-Ryder Nadelhalter	2-21, 3-16, 14-27		
Mikro-Schere	4-8		
Mikuřicz	7-13	O	
Mikuřicz Tonsillenklemme	7-13	Ochsner-Kocher	3-13, 7-12
Miller	3-46, 16-4	Ohrhäkchen	2-9
Miller Laryngoskop	16-4	Ohrhebel	2-11
Miller Nasenraspel	3-46	Ohrküretten	2-11
Milesi	12-7	Ohrkupe	2-4
Mini-Gefäßclip	12-18	Ohrpolypenschlingen	2-7
Mini-Ophthalmoskop 2000	1-7	Ohrpolypenschnürer Krause	2-7
Mini-Otoskop 2000	1-7	Ohrscheren	2-32
Moritz-Schmidt Zungenspatel	10-1	Ohrschnellen	2-9, 2-11
Muck	2-24, 5-2, 7-11		

Ohrsonde	2-35	Prince Tonsillenschere	7-11
Ohrspritze	2-2	Probeexcisionszange	5-20
Ohrtamponadenzange	2-7	Pulverbüser	2-2, 10-6
Ohrtrichter	2-3		
Ohrtrichter-Halter	3-23	Q	
Ohrtrichter-Ständer	2-4	Quetschzange	2-17, 3-25, 3-47
Ohrzängchen mit Zielgriff	2-32		
Ohrzange Praxismodell	2-32	R	
Ohrzangen	2-32	RANEY	12-55
Oldberg	12-56	Raspatorien	2-23, 2-24, 3-32, 3-33, 3-34, 3-36
Olivecrona	12-53, 12-54	Raspatorium m. Ferrozeilgriff	2-23
Olsen-Hegar Nadelhalter	3-16	Rauchabsaugrohr	8-1
OP Mikroskope	20-6	Reichert	10-6
OP-Laryngoskop	8-1, 8-2	Reil	12-13, 12-14
OP-Ständer für Mikro-Ohrzängchen	2-33	Reinigungs-Pistole	20-3
Operationslaryngoskop	8-1	Reinigungsspray	2-41
Opök	5-8	Reuter	3-50
Optische Sinuskopiezange	5-9	Reuter Nasenrachentubus	3-50
Orbitaschützer	5-3	Reynolds	3-6
Osseoscalpell	2-38	Reynolds - Schere	3-6
Ostrum Antrumstanze	5-22	Ring Spatel	7-6
		Ringmesser	6-1
P		Ringpinzetten TITAN	12-17
P950	2-37	Rippenschere	3-47
Papavero-Caspar Spekula	4-6	Ritter	5-1
Paracentesenadel	2-8	Ritter Bougie	5-1
Partsch	2-22	Ritzmesser	3-35
Paukenspiegel	2-30	Roberts	7-13
Paukenspültrichter	2-35	Roberts Tonsillenklemme	7-13
PE-Zange	5-10, 5-20	Rochester-Pean	3-13, 7-12
Pean	7-12	Roederbinder	7-16
Pean Tonsillenklemme	7-12	Röttgen	12-3, 14-34
Pennington	3-32	Röttgen Dissektoren	12-3
Pennington Elevatorium	3-32	Röttgen-Ruskin	13-14, 14-33
Perforatoren	2-31	Röttgen-Ruskin Hohlmeißelzangen	13-14, 14-33
Perostmesser Muck	2-24	Rongeur	12-57
Penschwitschy	7-7, 7-8	Rosen	2-29
Penschwitschy Speichelgangschere	7-7	Roser-König	16-5
Penschwitschy Tonsillennmesser	7-8	Roser-König Mundsperrer	16-5
Pinzette zur Insertion	3-4	Rotter	7-19
Pinzetten	2-13, 3-2, 3-3, 3-4, 4-3, 12-4, 12-5, 12-6, 12-11, 12-16, 14-3, 14-4, 17-9, 17-10, 17-11	Rotter Umstechungsnadel	7-19
Pinzetten bajonettförmig	12-4, 12-5, 12-6	Rowland	3-25
Plastikmesser	3-35	Rowland Knorpelschere	3-25
Plester	2-16, 2-23, 2-28, 2-29, 2-30	Rubin	3-25, 3-47
Plester Führungsgabel	2-29	Rubin Quetschzange	3-25, 3-47
Plester Mikro-Instrumente	2-29	Rundschnittmesser	2-30
Plester Raspatorium	2-23	Ruskin Hohlmeißelzangen	2-25, 13-11, 14-30
Plester Rundschnittmesser	2-30	Ruskin-Rowland	3-25
Plester Saugrohr	2-28	Ruskin-Rowland Knorpelschere	3-25
Plester Sichelmesser	2-30	Ryder	2-21
Plester Wundspitzer	2-16		
Pöltzer Paracentesenadel	2-8	S	
Pöltzer-Ballon	2-1	S-M Klängen	2-12, 3-1, 7-8, 14-1
Pöltzer-Oliven	2-1	Säge oszillierend	2-38
Polypenschlingen	2-7	Säge sagital	2-38
Postrhinoskopie Spiegel	5-11, 6-4	Sami	12-5
Potts-Neivert	14-4	Saug- und Koagulationsrohr	8-7
Potts-Smith	7-11, 14-4	Saug- und Spülgriff	2-34, 5-10, 5-18
Potts-Smith Tonsillenschere	7-11	Saugelevatorium	7-14
Potts-Yasargil	12-7	Sauger	2-27, 2-28, 3-24, 5-8, 8-6
Präparierklemmen	3-12	Sauger konisch	5-11
Präpariersauger	3-24	Sauggriffe	2-27, 2-28
Präparierschere	3-7	Saugrohre	2-27, 2-28, 3-24, 4-4, 5-11, 14-26
Präparierbleit	3-47	Schädelhalter	12-1
Praxisrichtung	20-4, 20-5, 20-6, 20-7		
Praxisauger	20-2		
Prince	7-11		



Inhalt Instrumentenkatalog 09-0010-00 H

Schädelzange	12-2	Spülrohre	5-1, 5-2
Scharfe Zange	3-27, 4-8	Spülsauger	5-8
Scharfer Löffel	5-5	Spurling Rongeure	12-57
Scheinmann	10-5	Stache Ohrsonde	2-35
Scheren	2-14, 2-15, 3-5, 3-6, 3-7, 3-8, 3-9, 3-10, 4-8, 8-3, 8-4, 14-5, 14-6, 14-7, 14-8, 14-9, 14-10, 14-11, 14-12, 14-13, 14-14, 14-15, 14-16, 14-17, 14-18, 14-19	Ständer für Ohrzängchen	2-33
Schilddrüsenhaken	9-4	Standard-Gefäßclips	12-18
Schmeden	3-31, 5-15, 6-5	Stanze, retrograd	3-27, 5-16
Schmeden Nasenrachenzange	6-5	Stanzen	2-32, 3-27, 5-16, 5-18, 12-58, 13-9
Schmeden Nasenzange	3-31, 5-15	Steckdosentransformator für Stimlampen	1-8
Schmiermittel	2-41	Steilbrink Hohlmeißelzangen	13-10, 14-29
Schneideblock	2-35	Steril-Container	19-3, 19-4
Schnitt	7-12	Steril-Kassetten	19-5
Schnittfräser	12-60	Sternberg Lippenhalter	5-3, 10-1
Schnürer	8-6	Stevens	3-8
Schoenborn	9-4	Stevens - Schere	3-8
Schoenborn Schilddrüsenhaken	9-4	Stimmgabel	2-5
Schraubendreher für Distractions-Schrauben	13-7	Stimmband	1-1
Schuknecht	2-15, 2-36	Stimhöhlenbougie	5-1
Schuknecht Schere	2-15	Stimlampe nach Clar	1-4
Schuknecht Turm	2-36	Stimlampen mit Kaltlichtbeleuchtung	1-5
Schwingmesser	3-35	Stimlampen mit konventioneller Beleuchtung	1-4
Scriptograph	20-1	Stimreflektor	1-1, 1-2, 1-3
Seiffert	2-31, 7-7, 10-5	Stoppuhr	2-2
Seiffert Tubensonde	2-31, 7-7	Stredel-Stille	14-23
Senn-Miller	9-3	Stimhöhlen-Löffel	5-19
Senn-Miller Tracheal-Häkchen	9-3	Strümpel	2-32
Senning	3-15	Strümpel Ohrzängchen	2-32
Senning Nadelhalter	3-15	Struycken	3-31, 5-15
Septumkanülen	3-11, 7-7	Struycken Nasenzange	3-31, 5-15
Septummesser	3-35		
Septumnadel	3-50	T	
Septumspritze	3-11	Takahashi	3-27, 5-16, 5-22
Sewall	3-34	Takahashi Biopsyzange	5-22
Sewall Raspatorium	3-34	Takahashi scharfe Nasenzange	3-27, 5-16
Shea-Schere	2-15, 3-5	Taylor	14-3
Sialographie	7-7	TE-Sauger	7-10
Sichelmesser	2-30, 5-6, 8-5	Tellerfräser	2-42
Siebenmann	5-2	Tellermesser	2-30, 8-5
Siebenmann Spülrohr	5-2	Tenotom	2-31
Silbersauger	2-28	Textilbinde	17-1
Silikon K-H Schlauch	5-2	Therapieplättze	20-4
Sinuskopie	5-8, 5-18, 5-19, 5-20, 5-21, 5-22, 5-23	Thermodesinfektoren	20-3
Sinuskopiezange	5-9	Thiesen	2-22
Skalpellgriffe	2-12	Thiesen Flachmeißel	2-22
Skalpellklingen	2-12, 3-1, 14-1	Thiesen Hohlmeißel	2-22
Sluder-Ballenger	7-14	Thilenius	7-16
Sluder-Ballenger Tonsillotom	7-14	Thilenius Abszeßzange	7-16
Sonden	1-2, 7-7, 12-1	Thornwald	5-4
Spannam	3-23	Thornwald Kieferhöhlenbohrer	5-4
Spatel	7-3, 7-4, 7-5, 7-6, 16-1, 16-2, 16-3, 16-4	Tieck-Halle	3-20
Speichelgangschere	7-7	Tieck-Halle Nasenspekula	3-20
Spekula	4-5, 4-6	Tiefenmessinstrument	2-31
Spekula für Rückenoperationen	13-1, 13-2	Tiley Nasentamponadenzange	3-18
Spencer - Fadenschere	2-14	Tischtransformator für Stimlampen	1-8
Spender für Watte	20-2	Tobold Zungenspatel	10-1
Sperrer	2-18	Tönnis	12-3, 14-28, 14-34
Spiegel	10-2	Tönnis-Adson	14-9, 14-17
Spiegel f. Stirnreflektor	1-3	Tonsillektomie-Sauger	7-10
Spiegelgriffe	10-2	Tonsillelevatorien	7-14, 7-15
Spiralbohrer	12-60	Tonsillenfaßzange	7-9
Spratt	5-5	Tonsillenklemmen	7-12, 7-13
Spratt Scharfer Löffel	5-5	Tonsillenkompessorium	7-17
Spraynet 500	2-41	Tonsillennmesser	7-8
Spreizer	2-18, 4-6, 9-1	Tonsillenzippen	7-9
Sprezzange	4-5	Tonsillenscheren	7-11
Sprezzange Spekula	4-5	Tonsillenschlingen	7-15
Spül- und Saugrohr	2-28, 5-8	Tonsillenschnürer	7-15
Spülkanülen	5-1, 5-2	Tonsillotom	7-14

Tracheal - Hakchen	2-19, 9-3, 14-22	Webster Nadelhalter	3-15
Trachealspekulum	9-2	Weerda	8-2, 9-2
Tracheostomaspreizer	9-1, 9-2	Weerda Tracheostomaspreizer	8-2
Trautmann	2-22	Weilener	2-16, 14-25
Trautmann Flachmeiel	2-22	Weilener Wundspreizer	2-16
Trautmann Hohlmeiel	2-22	Westmacott	3-17
Trokar	5-1, 5-2, 5-8, 5-11, 9-4	Westmacott Nasentamponadenzange	3-17
Trotisch - Pinzette	2-13, 3-2	Whitehead Mundsperrer	7-2
Trosseau	9-1	Wiegand	2-17, 2-34
Trosseau Tracheostomaspreizer	9-1	Wiegand Saug- und Spulgriff	2-34
Tubenkatheter	2-3	Wiegand Wundspreizer	2-17
Tubensonde	2-31, 7-7	Wilder	7-7
Tuchklemmen	3-14	Wilder Dilator	7-7
Tumorzange	12-56	Willing	2-15, 2-24, 3-36, 5-5
Tupferbehalter	19-1	Willing Elevatorium	2-24
Turn z. Biegen von Drahtlosen	2-36	Willing Raspatorium	2-24, 3-36
Tyding	7-9	Willing Scharfer Loffel	5-5
Tyding Tonsillenfalzange	7-9	Willing Wundspreizer	2-16
U		Wirbelkorper	13-6
Uckermann	9-4	Wirbelkorper Distraaktions System	13-6
Uckermann Trokar	9-4	Wulstein	2-13, 2-16, 2-27, 2-28, 2-32, 3-2
Uffenorde	3-36, 5-5	Wulstein Aufstecksauger	2-28
Uffenorde Kieferhohlen-Loffel	5-5	Wulstein Ohrzangchen	2-32
Uffenorde Raspatorium	3-36	Wulstein Pinzette	2-13, 3-2
Umstechungsnadeln	7-18, 7-19, 8-5	Wulstein Sauggriff	2-27
Universal - Zerstauber	10-6	Wulstein Wundspreizer	2-16
Universalgriff	10-4	Wundhakchen	14-22, 14-23, 14-24, 14-25
Untersuchungsmikroskope	20-7	Wundhaken	5-3
V		Wundspreizer	2-16, 2-17, 13-3, 13-5, 14-25
Vannas	12-7, 12-8	Wundspreizer fur die Wirbelsaule	13-3, 13-5
Velotraktor	6-3	Y	
Ventrikul-Kanule	14-2	Yankauer	3-50, 7-10
Verbandschere	3-8	Yankauer Septumnadel	3-50
Vetter	7-17	Yankauer Tonsillektomie-Sauger	7-10
Vetter Tonsillenkompessorium	7-17	Yasargil	12-4, 12-6, 12-7, 12-8, 12-18, 12-49, 12-55, 12-56, 14-36
VISITAT Kaltlichtprojektor	1-6	Yasargil-Nicola	4-8
Vogel	5-1	Yasargil-Samil	12-4
Vogel Spulkanule	5-1	Young	16-5
Volkmann	5-5, 14-23	Young Zungenzange	16-5
Volkmann Scharfer Loffel	5-5	Z	
W		Zahnschutz	8-6
Wagner	2-1, 2-9, 5-11, 9-2	Zangenbehalter	19-1
Wagner Cerumenhakchen	2-9	Zaufal Ohrhebel	2-11
Wagner Intubationsrohr	9-2	Zerstauber	2-1, 5-11, 6-2, 10-6, 10-8
Wagner Zerstauber	2-1, 5-11	Zerstauber mit Schauglas	2-1
Walsham	3-48	Ziegler Watte-trager	3-18
Walsham Nasenrichtzange	3-48	Zirkel	3-47
Walter	3-8, 3-22, 3-33, 3-38, 3-40	Zolner Aufstecksauger	2-28
Walter Meiel	3-38	Zungenspatel	7-3, 7-4, 7-5, 7-6, 10-1
Walter Nasenflugelhaken	3-40	Zungenzange	16-5
Walter Nasenspekula	3-22	Zweifel Nadelhalter	14-28
Walter Raspatorium	3-33		
Walter Schere	3-8		
Watson-Williams	3-27, 5-2		
Watson-Williams scharfe Nasenzange	3-27		
Watson-Williams Spulrohr	5-2		
Wattebehalter	19-1		
Wattespender	19-2, 20-2		
Watte-trager	2-10, 3-18, 5-6, 5-8, 6-6		
Weber-Loch Ohrschlinge	2-11		
Webster	3-15		



Inhalt Instrumentenkatalog 09-0010-00 H

11-0180-00	5-8	12-0022-00	14-1	14-0414-00	7-9
11-0181-00	5-8	12-0023-00	14-1	14-0970-00	3-3
11-0183-00	5-8	12-0803-00 K	3-35	14-0974-00	3-3
11-0184-00	5-8	12-0805-00	5-6	14-0976-00	3-3
11-0186-00	5-9	12-0820-00	7-7	14-2262-00	7-9
11-0189-00	5-9	12-0825-00	7-7	14-9640-00	3-4
11-0402-00	5-10, 5-18	12-0826-00	7-7	15-0080-00	2-15, 3-5
11-0402-01	5-10	12-0827-00	7-7	15-0081-00	2-15, 3-5
11-0402-03	5-10	12-0830-00	7-7	15-0095-00	7-7
11-0402-07	5-10	12-0831-00	7-7	15-0110-00	2-14, 3-6
11-0410-00	5-11	12-0837-00	14-2	15-0111-00	2-14, 3-6
11-0410-04	5-11	12-0837-05	14-2	15-0117-00	2-14, 3-6
11-1012-34	1-7	12-0838-00	14-2	15-0118-00	3-8
11-1012-45	1-7	12-0838-05	14-2	15-0120-12	14-5
11-1030-00	1-3	12-0862-00	3-35	15-0121-12	14-5
11-1031-00	1-3	12-0864-00	3-35	15-0127-00	2-14, 3-6
11-1032-00	1-3	12-0865-00	3-35	15-0128-00	2-14, 3-6
11-1033-00	1-3	12-0867-00	3-35	15-0131-00	3-7
11-1036-02	1-3	12-1170-00	3-11, 7-7	15-0132-00	3-7
11-1041-00	1-1	12-1171-00	3-11, 7-7	15-0133-00	3-7
11-1043-01	1-2	12-1172-00	3-11, 7-7	15-0134-00	3-7
11-1043-02	1-2	12-1173-00	3-11, 7-7	15-0135-00	3-7
11-1043-18	1-2	12-1280-00	14-2	15-0136-00	3-7
11-1043-19	1-2	12-9010-00	7-16	15-0142-00	3-7
11-1044-00	1-2	12-9011-00	7-16	15-0143-00	3-7
11-1045-00	1-2	12-9012-00	7-16	15-0150-00	2-15, 3-5
11-1046-00	1-2	13-0010-00	3-3	15-0151-00	2-15, 3-5
11-1046-02	1-2	13-0100-00	2-13, 3-2	15-0152-00	7-7
11-1047-00	1-1	13-0103-00	7-9	15-0153-16	14-5
11-1048-18	1-1	13-0151-00	2-13, 3-2	15-0154-16	14-5
11-1047-19	1-1	13-0160-00	2-13, 3-2	15-0165-00	3-8
11-1048-00	1-1	13-0164-00	2-13	15-0166-00	3-8
11-1048-19	1-1	13-0170-00	2-13	15-0167-00	3-8
11-1050-00	1-1	13-0200-00	14-3	15-0177-15	14-7
11-1051-00	1-1	13-0217-00	14-3	15-0178-15	14-7
11-1052-00	1-1	13-0270-00	7-9	15-0179-15	14-6
11-1071-00	1-4	13-0292-00	2-13, 3-2	15-0180-15	14-6
11-1071-01	1-4	13-0294-00	2-13, 3-2	15-0181-15	14-6
11-1085-00	1-8	13-0300-00	2-13, 3-2	15-0181-18	14-6
11-1087-00	1-8	13-0360-00	2-13	15-0181-20	14-6
11-1088-00	1-8	13-0455-00	3-2	15-0181-23	14-6
11-1400-00	1-5	13-2250-00	3-2	15-0182-00	3-8
11-1415-01	1-4	13-8400-00	3-4	15-0182-00 M	3-8
11-1415-03	1-4	13-9620-00	2-13, 3-2	15-0182-15	14-6
11-1421-01	1-5	13-9621-00	3-2	15-0182-18	14-6
11-1421-02	1-5	13-9638-00	14-3	15-0182-20	14-6
11-1421-04	1-5	13-9639-00	14-3	15-0182-23	14-6
11-1421-05	1-5	13-9645-00	3-4	15-0183-15	14-7
11-1505-00	1-6	13-9650-00	2-13, 3-2	15-0183-18	14-7
11-1505-02	1-6	13-9652-00	2-13	15-0183-20	14-7
11-1506-00	1-6	13-9653-00	3-2	15-0183-23	14-7
11-4000-00 W	5-8	13-9654-00	3-2	15-0184-00	3-8
11-4030-00 W	5-8	13-9724-00	2-13, 3-2	15-0184-15	14-7
11-4070-00 W	5-8	13-9739-17	14-4	15-0184-18	14-7
11-4200-00 W	5-9	13-9740-18	14-4	15-0184-20	14-7
11-4230-00 W	5-9	13-9760-00	2-13, 3-2	15-0184-23	14-7
11-4270-00 W	5-9	13-9772-14	14-4	15-0187-18	14-8
11-8034-00	1-6	13-9772-17	14-4	15-0187-20	14-8
11-8188-00	1-7	13-9772-20	14-4	15-0187-23	14-8
11-8191-00	1-7	13-9772-25	14-4	15-0188-18	14-8
11-8198-01	1-7	13-9804-00	2-13	15-0188-20	14-8
11-8760-00	1-4	14-0010-00	3-3	15-0188-23	14-8
12-0003-00	2-12, 3-1, 14-1	14-0103-00	7-9	15-0193-00	3-8
12-0003-00 L	2-12, 3-1, 7-8, 14-1	14-0151-00	3-3	15-0201-00	7-11
12-0004-00	14-1	14-0152-00	3-3	15-0238-17	14-12
12-0004-00 L	14-1	14-0160-00	3-3	15-0238-23	14-12
12-0007-00	2-12, 3-1, 7-8, 14-1	14-0200-00	14-3	15-0239-17	14-12
12-0010-00	2-12, 3-1, 7-8, 14-1	14-0217-00	14-3	15-0240-00	7-11
12-0011-00	2-12, 3-1, 7-8, 14-1	14-0292-00	3-3	15-0242-00	7-11
12-0012-00	2-12, 3-1, 7-8, 14-1	14-0294-00	3-3	15-0244-00	7-11
12-0015-00	2-12, 3-1, 7-8, 14-1	14-0295-00	3-3	15-0245-00	7-11
12-0020-00	14-1	14-0298-00	3-3	15-0246-00	7-11
12-0021-00	14-1	14-0404-00	7-9	15-0248-00	7-11

15-0248-01	7-11	15-180-15	14-18	17-0404-00	3-13
15-0249-00	7-11	15-181-15	14-18	17-0405-00	3-13
15-0266-00	3-7	15-181-18	14-18	17-0406-00	7-12
15-0266-00 M	3-7	15-181-20	14-18	17-0407-00	7-12
15-0266-16	14-9	15-181-23	14-18	17-0536-00	7-12
15-0280-00	2-14	15-182-15	14-18	17-0537-00	7-12
15-0296-17	14-9	15-182-18	14-18	17-0539-00	7-12
15-0299-00	2-15, 3-5	15-182-20	14-18	17-0541-00	7-13
15-0300-00	2-15, 3-5	15-182-23	14-18	17-0543-00	7-13
15-0311-00	3-6	15-183-15	14-19	17-0605-00	7-13
15-0320-00	3-5	15-183-18	14-19	17-0635-00	7-13
15-0321-01	3-5	15-183-20	14-19	17-0636-00	7-13
15-0321-02	3-5	15-183-23	14-19	17-0700-00	7-13
15-0321-04	3-5	15-184-15	14-19	17-0701-00	7-13
15-0324-00	3-5	15-184-18	14-19	17-0718-00	7-13
15-0327-00	3-10	15-184-20	14-19	17-0720-00	7-13
15-0328-00	3-10	15-184-23	14-19	17-1010-10	12-51, 14-20
15-0329-00	3-10	17-0010-50	12-51, 14-20	19-0109-00	3-14
15-0390-18	14-10	17-0011-50	12-51, 14-20	19-0111-00	3-14
15-0391-18	14-10	17-0013-57	12-51, 14-20	19-0518-00	3-14
15-0392-18	14-10	17-0015-73	12-51, 14-20	19-0519-00	3-14
15-0393-18	14-10	17-0016-33	12-52, 14-21	19-0520-00	3-14
15-0394-18	14-10	17-0016-50	12-52, 14-21	19-0521-00	3-14
15-0397-18	14-11	17-0016-69	12-52, 14-21	22-0260-00	2-28
15-0398-18	14-11	17-0017-33	12-52, 14-21	24-0001-00	2-19, 9-3, 14-22
15-0399-18	14-11	17-0017-50	12-52, 14-21	24-0002-00	2-19, 9-3, 14-22
15-0400-18	14-11	17-0017-69	12-52, 14-21	24-0003-00	2-19, 9-3, 14-22
15-0401-18	14-11	17-0040-40	12-51, 14-20	24-0004-00	2-19, 9-3, 14-22
15-0547-00	3-43	17-0040-45	12-51, 14-20	24-0011-00	9-3
15-0549-00	3-43	17-0041-40	12-51, 14-20	24-0021-00	2-19, 9-3
15-0561-00	2-15	17-0041-45	12-51, 14-20	24-0022-00	2-19, 9-3
15-0614-00	3-9	17-0042-40	12-51, 14-20	24-0023-00	2-19, 9-3
15-0624-00	3-9	17-0043-45	12-51, 14-20	24-0024-00	2-19, 9-3
15-0634-00	3-9	17-0060-25	12-52, 14-21	24-0031-00	2-19, 9-3, 14-22
15-0644-00	3-9	17-0060-35	12-52, 14-21	24-0032-00	2-19, 9-3, 14-22
15-0654-00	3-9	17-0060-50	12-52, 14-21	24-0033-00	2-19, 9-3, 14-22
15-0694-00 M	3-9	17-0060-68	12-52, 14-21	24-0034-00	2-19, 9-3, 14-22
15-0695-00 M	3-9	17-0061-25	12-52, 14-21	24-0070-00	14-23
15-0696-00 M	3-9	17-0061-35	12-52, 14-21	24-0071-00	14-23
15-0697-00 M	3-9	17-0061-50	12-52, 14-21	24-0072-00	14-22
15-0698-00 M	3-9	17-0061-68	12-52, 14-21	24-0073-00	14-22
15-2153-16	14-13	17-0240-00	2-20	24-0074-00	14-22
15-2154-16	14-13	17-0241-00	2-20	24-0081-07	12-55
15-2177-15	14-16	17-0242-00	2-20	24-0081-09	12-55
15-2178-15	14-16	17-0243-00	2-20	24-0082-00	14-22
15-2179-15	14-14	17-0252-00	2-20	24-0083-00	14-22
15-2180-15	14-14	17-0253-00	2-20	24-0084-00	14-22
15-2181-15	14-14	17-0254-00	2-20	24-0102-00	14-23
15-2181-18	14-15	17-0255-00	2-20	24-0103-00	14-23
15-2181-20	14-15	17-0256-00	3-12	24-0104-00	14-23
15-2181-23	14-15	17-0257-00	3-12	24-0106-00	14-23
15-2182-15	14-14	17-0258-00	3-12	24-0112-00	14-23
15-2182-18	14-15	17-0259-00	3-12	24-0113-00	14-23
15-2182-20	14-15	17-0260-00	2-20	24-0114-00	14-23
15-2182-23	14-15	17-0261-00	2-20	24-0116-00	14-23
15-2183-15	14-16	17-0262-00	2-20	24-0122-00	14-23
15-2183-18	14-16	17-0263-00	2-20	24-0123-00	14-23
15-2183-20	14-16	17-0270-00	2-20	24-0124-00	14-23
15-2183-23	14-16	17-0271-00	2-20	24-0126-00	14-23
15-2184-15	14-16	17-0272-00	2-20	24-0130-00	9-3
15-2184-18	14-16	17-0273-00	2-20	24-0131-00	3-42
15-2184-20	14-16	17-0288-00	2-20, 3-12	24-0142-00	14-23
15-2184-23	14-16	17-0289-00	3-12	24-0143-00	14-23
15-2187-18	14-17	17-0290-00	3-13	24-0144-00	14-23
15-2187-20	14-17	17-0291-00	3-13	24-0146-00	14-23
15-2187-23	14-17	17-0300-00	3-13	24-0150-01	3-40
15-2188-18	14-17	17-0301-00	3-13	24-0150-02	3-40
15-2188-20	14-17	17-0304-00	3-13	24-0152-00	3-42
15-2188-23	14-17	17-0305-00	3-13	24-0154-00	3-42
15-2296-17	14-17	17-0306-00	7-12	24-0156-00	3-42
15-4177-15	14-19	17-0307-00	7-12	24-0157-00	3-42
15-4178-15	14-19	17-0400-00	3-13	24-0159-00	14-24
15-4179-15	14-18	17-0401-00	3-13	24-0160-00	14-24



32-0315-00	2-21, 3-16, 14-27	37-4392-07	2-22	40-0101-50	16-3
32-0318-00	3-16, 14-27	37-4392-08	2-22	40-0101-51	16-3
32-0320-00	3-16, 14-27	37-4393-02	2-22	40-0101-52	16-3
32-0323-00	14-27	37-4393-03	2-22	40-0101-53	16-3
32-6395-00	14-28	37-4393-05	2-22	40-0101-54	16-3
32-6407-00	14-28	37-4393-07	2-22	40-0101-60	16-4
32-6408-00	14-28	37-4393-08	2-22	40-0101-61	16-4
34-0421-00	9-4	37-4501-00	5-5	40-0101-62	16-4
36-0316-00	13-12	37-4502-00	5-5	40-0101-63	16-4
36-0316-03	13-12	37-4503-00	5-5	40-0101-64	16-4
36-0772-03	13-10, 14-29	37-4505-00	5-5	40-0220-00	16-6
36-0779-02	13-10, 14-29	37-4506-00	5-5	40-0230-00	16-6
36-0780-02	13-10, 14-29	37-4507-00	5-5	40-0240-00	16-6
36-0780-03	13-10, 14-29	37-4508-00	5-5	45-0001-00	13-6
36-0782-02	13-10, 14-29	37-4509-00	5-5	45-0001-02	13-6
36-0783-02	13-10, 14-29	37-4510-00	5-5	45-0001-04	13-7
36-0810-00	2-25	37-4511-00	5-5	45-0001-06	13-7
36-0810-03	13-11, 14-30	37-4512-00	5-5	45-0010-00	12-60
36-0810-04	2-25, 13-11, 14-30	37-4538-00	5-5	45-0030-18	12-56
36-0811-04	13-12, 14-31	37-4539-00	5-5	45-0032-19	12-56
36-0812-00	2-25	37-4540-00	5-5	45-0034-19	12-56
36-0812-04	13-11, 14-30	37-4541-00	5-5	45-0038-20	12-56
36-0812-05	13-11, 14-30	37-4542-00	5-5	45-0050-01	12-1
36-0813-00	2-25	37-4543-00	5-5	45-0050-013	12-1
36-0813-02	13-12, 14-31	37-4550-00	5-5	45-0058-20	12-2
36-0816-00	2-25, 14-31	37-4551-00	5-5	45-0058-21	12-2
36-0816-03	2-25, 14-31	37-4552-00	5-5	45-0060-00	12-55
36-0817-02	13-12	37-4553-00	5-5	45-0061-01	12-55
36-0818-08	13-11, 14-30	37-4554-01	5-6, 5-19	45-0061-02	12-55
36-0819-05	13-14, 14-33	37-4554-02	5-6, 5-19	45-0095-45	13-1
36-0819-06	13-14, 14-33	37-4554-03	5-6, 5-19	45-0095-50	13-1
36-0826-03	13-12, 14-31	37-4554-04	5-19	45-0095-55	13-1
36-0850-03	13-13, 14-32	37-4555-00	5-6, 5-19	45-0095-60	13-1
36-0850-05	13-13, 14-32	37-4555-02	5-6, 5-19	45-0095-85	13-1
36-0850-06	13-13, 14-32	37-4555-04	5-19	45-0096-40	13-2
36-0850-08	13-13, 14-32	37-4557-02	5-19	45-0096-45	13-2
36-0854-06	13-13, 14-32	37-4557-04	5-19	45-0096-50	13-2
36-0854-08	13-13, 14-32	37-4700-00	2-24	45-0096-55	13-2
36-0862-02	13-13, 14-32	37-4703-00	3-36	45-0096-60	13-2
36-0862-03	13-13, 14-32	37-4711-00	3-36	45-0096-65	13-2
36-0862-04	13-13, 14-32	37-4716-00	2-23	45-0096-75	13-2
37-0006-00	2-22, 3-37	37-4717-00	2-23	45-0096-85	13-2
37-0010-00	3-37	37-4718-00	2-23	45-0100-07	4-5
37-0011-00	2-22, 3-37	37-4740-00	3-36	45-0100-09	4-5
37-0034-00	2-22	37-4741-00	3-36	45-0100-11	4-5
37-0036-00	2-22	37-4774-00	2-24	45-0100-20	4-5
37-0038-00	2-22	37-4776-00	2-24, 3-36	45-0101-08	4-6
37-0040-00	2-22	37-4784-00	3-33	45-0101-09	4-6
37-0050-00	4-7, 3-37	37-4790-00	2-23	45-0101-10	4-6
37-0054-00	2-22	37-4791-00	2-23	45-0102-01	4-1
37-0056-00	2-22	37-4801-00	3-36	45-0102-02	4-1
37-0058-00	2-22	37-4802-00	3-36	45-0102-03	4-1
37-0060-00	2-22	37-4816-00	2-24	45-0103-02	4-2
37-0062-00	2-22	37-4817-00	2-24	45-0103-03	4-2
37-0064-00	2-22	40-4001-00	16-5	45-0103-04	4-2
37-0072-00	2-22	40-4004-00	16-5	45-0103-05	4-2
37-0073-00	2-22	40-4030-00	16-5	45-0103-06	4-2
37-0074-00	2-22	40-4048-00	16-5	45-0103-07	4-2
37-0075-00	2-22	40-4101-00	16-1	45-0113-02	4-2
37-0082-00	2-22	40-4101-01	16-1	45-0113-03	4-2
37-0083-00	2-22	40-4101-02	16-1	45-0113-04	4-2
37-0084-00	2-22	40-4101-03	16-1	45-0113-05	4-2
37-0085-00	2-22	40-4101-04	16-1	45-0113-06	4-2
37-0182-00	2-22	40-4101-10	16-1	45-0113-07	4-2
37-0183-00	2-22	40-4101-12	16-2	45-0116-01	4-3
37-0184-00	2-22	40-4101-121	16-2	45-0116-02	4-3
37-0185-00	2-22	40-4101-122	16-1	45-0116-03	4-3
37-0186-00	2-22	40-4101-123	16-1	45-0116-04	4-3
37-0187-00	2-22	40-0101-20	16-2	45-0116-05	4-3
37-0188-00	2-22	40-0101-21	16-2	45-0116-06	4-3
37-0392-02	2-22	40-0101-22	16-2	45-0116-07	4-3
37-0392-03	2-22	40-0101-23	16-2	45-0117-02	4-3
37-0392-05	2-22	40-0101-24	16-2	45-0117-03	4-3

Inhalt Instrumentenkatalog 09-0010-00 H

45-0117-04	4-3	45-0441-13	12-57	45-0711-00	12-1
45-0117-05	4-3	45-0442-13	12-57	45-0712-00	12-1
45-0117-06	4-3	45-0442-18	12-57	45-1011-09	12-53
45-0117-07	4-3	45-0444-16	12-57	45-1011-12	12-53
45-0118-02	4-3	45-0445-16	12-57	45-1012-11	12-53
45-0118-03	4-3	45-0446-16	12-57	45-1025-07	12-53
45-0118-04	4-3	45-0476-01	12-58, 13-9	45-1025-11	12-53
45-0121-00	4-4	45-0476-02	12-58, 13-9	45-1025-15	12-53
45-0122-00	4-4	45-0476-03	12-58, 13-9	45-1025-18	12-53
45-0123-00	4-4	45-0478-01	12-58, 13-9	45-1032-14	12-54
45-0124-00	4-4	45-0478-02	12-58, 13-9	45-1032-17	12-54
45-0126-00	4-4	45-0478-03	12-58, 13-9	45-1032-20	12-54
45-0131-00	4-4	45-0480-00	2-26, 5-18	45-1034-08	12-54
45-0132-00	4-4	45-0481-00	2-26, 5-18	45-1034-11	12-54
45-0133-00	4-4	45-0482-00	2-26, 5-18	45-1034-14	12-54
45-0134-00	4-4	45-0499-02	12-58, 13-9	45-1034-17	12-54
45-0136-00	4-4	45-0499-03	12-58, 13-9	45-1046-07	12-53
45-0303-00	12-60	45-0499-04	12-58, 13-9	45-1046-11	12-53
45-0368-00 N	4-9, 12-59, 13-8	45-0499-05	12-58, 13-9	45-1046-15	12-53
45-0369-00 N	4-9, 12-59, 13-8	45-0500-02	12-58, 13-9	45-1046-18	12-53
45-0371-00 N	4-9, 12-59, 13-8	45-0500-03	12-58, 13-9	45-6901-40	5-23
45-0372-00 N	4-9, 12-59, 13-8	45-0500-04	12-58, 13-9	45-6901-41	5-23
45-0373-00 N	4-9, 12-59, 13-8	45-0500-05	12-58, 13-9	45-6901-42	5-23
45-0374-00 N	4-9, 12-59, 13-8	45-0501-01	12-58	45-6970-00 H	4-8
45-0375-00 N	4-9, 12-59, 13-8	45-0501-02	12-58	45-6971-00	4-8
45-0376-00 N	4-9, 12-59, 13-8	45-0501-03	12-58	45-6972-00	4-8
45-0388-00 N	4-9, 12-59, 13-8	45-0501-04	12-58	45-6973-00	4-8
45-0389-00 N	4-9, 12-59, 13-8	45-0501-05	12-58	45-6978-00	5-10, 5-20
45-0391-00 N	4-9, 12-59, 13-8	45-0502-01	12-58	45-7001-00	12-3, 14-34
45-0392-00 N	4-9, 12-59, 13-8	45-0502-02	12-58	45-7002-00	12-3, 14-34
45-0392-14 N	4-9, 12-59, 13-8	45-0502-03	12-58	45-7003-00	12-3, 14-34
45-0393-00 N	4-9, 12-59, 13-8	45-0502-04	12-58	45-7005-00	12-3, 14-34
45-0393-16 N	4-9, 12-59, 13-8	45-0502-05	12-58	45-7009-00	12-3, 14-34
45-0394-00 N	4-9, 12-59, 13-8	45-0503-01	12-58	45-7010-04	12-1
45-0395-00 N	4-9, 12-59, 13-8	45-0503-02	12-58	45-7010-05	12-1
45-0396-00 N	4-9, 12-59, 13-8	45-0503-03	12-58	45-7010-06	12-1
45-0398-00 N	12-59, 13-8	45-0503-04	12-58	45-7014-00	12-1
45-0398-14 N	12-59, 13-8	45-0503-05	12-58	48-1010-00	2-1
45-0399-00 N	12-59, 13-8	45-0504-01	12-58	48-1011-00A	2-1
45-0401-00 N	12-59, 13-8	45-0504-02	12-58	48-1011-00B	2-1
45-0402-00 N	12-59, 13-8	45-0504-03	12-58	48-1011-00F	2-1
45-0403-00 N	12-59, 13-8	45-0504-04	12-58	48-1012-00	2-1, 5-11
45-0404-00 N	12-59, 13-8	45-0504-05	12-58	48-1013-00	2-1, 10-8
45-0405-00 N	12-59, 13-8	45-0505-00	5-7	48-1014-00	2-1, 6-2
45-0406-00 N	12-59, 13-8	45-0512-00	5-7	48-1025-00	10-6
45-0408-00 N	12-59, 13-8	45-0512-45	5-18	48-1030-00	2-1, 10-8
45-0409-00 N	12-59, 13-8	45-0513-00	5-18	48-1034-00	2-1, 10-8
45-0411-00 N	12-59, 13-8	45-0513-02	5-18	48-1080-00	5-2
45-0412-00 N	12-59, 13-8	45-0513-03	5-18	48-1080-02	5-2
45-0413-00 N	12-59, 13-8	45-0513-04	5-18	55-0001-35	12-48
45-0414-00 N	12-59, 13-8	45-0513-05	5-18	55-0001-36	12-48
45-0414-20 H	3-26, 5-12	45-0514-00	5-7	55-0001-70	12-48
45-0415-00 N	12-59, 13-8	45-0520-00	2-26, 5-7	55-0001-71	12-48
45-0416-00 N	12-59, 13-8	45-0521-00	2-26, 5-7	55-0001-75	12-48
45-0420-13	12-57	45-0522-00	2-26, 5-7	55-0002-01 Y	12-18
45-0420-18	12-57	45-0523-01	3-27	55-0002-02 Y	12-18
45-0421-13	12-57	45-0523-01 U	5-16	55-0002-05	12-49
45-0422-13	12-57	45-0523-05	3-27	55-0002-10	12-49
45-0422-18	12-57	45-0523-05 U	5-16	55-0002-11	12-48, 12-49
45-0424-16	12-57	45-0523-06	3-27	55-0002-12	12-48, 12-49
45-0425-16	12-57	45-0523-06 U	5-16	55-0002-13	12-48, 12-49
45-0426-16	12-57	45-0525-00	2-26	55-0002-14	12-48, 12-49
45-0427-16	12-57	45-0526-00	2-26	55-0002-15	12-48
45-0430-13	12-57	45-0527-00	5-18	55-0002-17	12-49
45-0430-18	12-57	45-0527-02	5-18	55-0002-19	12-49
45-0431-13	12-57	45-0560-00	5-7	55-0002-20	12-49
45-0432-13	12-57	45-0561-00	5-7	55-0002-21	12-49
45-0432-18	12-57	45-0604-01	12-61	55-0002-22	12-49
45-0434-16	12-57	45-0604-02	12-61	55-0002-23	12-49
45-0435-16	12-57	45-0604-03	12-61	55-0002-24	12-49
45-0436-16	12-57	45-0604-04	12-61	55-0003-01 S	12-19
45-0440-13	12-57	45-0645-00	5-7	55-0003-01 ST	12-19
45-0440-18	12-57	45-0645-02	5-7	55-0003-02 S	12-19



HEIMOMED

Inhalt Instrumentenkatalog 09-0010-00 H

55-0003-02 ST	12-19	55-0003-126 S	12-33	55-0003-22 ST	12-21
55-0003-03 S	12-19	55-0003-126 ST	12-33	55-0003-23 S	12-21
55-0003-03 ST	12-19	55-0003-127 S	12-33	55-0003-23 ST	12-21
55-0003-04 S	12-19	55-0003-127 ST	12-33	55-0003-24 S	12-21
55-0003-04 ST	12-19	55-0003-128 S	12-34	55-0003-24 ST	12-21
55-0003-05 S	12-19	55-0003-128 ST	12-34	55-0003-25 S	12-21
55-0003-05 ST	12-19	55-0003-129 S	12-34	55-0003-25 ST	12-21
55-0003-06 S	12-19	55-0003-129 ST	12-34	55-0003-26 S	12-21
55-0003-06 ST	12-19	55-0003-13 S	12-20	55-0003-26 ST	12-21
55-0003-07 S	12-19	55-0003-13 ST	12-20	55-0003-27 S	12-21
55-0003-07 ST	12-19	55-0003-130 S	12-34	55-0003-27 ST	12-21
55-0003-08 S	12-19	55-0003-130 ST	12-34	55-0003-28 S	12-21
55-0003-08 ST	12-19	55-0003-131 S	12-34	55-0003-28 ST	12-21
55-0003-09 S	12-19	55-0003-131 ST	12-34	55-0003-29 S	12-21
55-0003-09 ST	12-19	55-0003-132 S	12-34	55-0003-29 ST	12-21
55-0003-10 S	12-19	55-0003-132 ST	12-34	55-0003-30 S	12-21
55-0003-10 ST	12-19	55-0003-133 S	12-34	55-0003-30 ST	12-21
55-0003-100 S	12-29	55-0003-133 ST	12-34	55-0003-31 S	12-22
55-0003-100 ST	12-29	55-0003-134 S	12-34	55-0003-31 ST	12-22
55-0003-101 S	12-29	55-0003-134 ST	12-34	55-0003-32 S	12-22
55-0003-101 ST	12-29	55-0003-135 S	12-34	55-0003-32 ST	12-22
55-0003-102 S	12-29	55-0003-135 ST	12-34	55-0003-33 S	12-22
55-0003-102 ST	12-29	55-0003-136 S	12-35	55-0003-33 ST	12-22
55-0003-103 S	12-30	55-0003-136 ST	12-35	55-0003-34 S	12-22
55-0003-103 ST	12-30	55-0003-137 S	12-35	55-0003-34 ST	12-22
55-0003-104 S	12-30	55-0003-137 ST	12-35	55-0003-35 S	12-22
55-0003-104 ST	12-30	55-0003-138 S	12-35	55-0003-35 ST	12-22
55-0003-105 S	12-30	55-0003-138 ST	12-35	55-0003-36 S	12-22
55-0003-105 ST	12-30	55-0003-139 S	12-35	55-0003-36 ST	12-22
55-0003-106 S	12-30	55-0003-139 ST	12-35	55-0003-37 S	12-22
55-0003-106 ST	12-30	55-0003-14 S	12-20	55-0003-37 ST	12-22
55-0003-107 S	12-31	55-0003-14 ST	12-20	55-0003-38 S	12-22
55-0003-107 ST	12-31	55-0003-140 S	12-35	55-0003-38 ST	12-22
55-0003-108 S	12-31	55-0003-140 ST	12-35	55-0003-39 S	12-22
55-0003-108 ST	12-31	55-0003-141 S	12-35	55-0003-39 ST	12-22
55-0003-109 S	12-31	55-0003-141 ST	12-35	55-0003-40 S	12-22
55-0003-109 ST	12-31	55-0003-142 S	12-35	55-0003-40 ST	12-22
55-0003-11 S	12-20	55-0003-142 ST	12-35	55-0003-41 S	12-23
55-0003-11 ST	12-20	55-0003-143 S	12-35	55-0003-41 ST	12-23
55-0003-110 S	12-31	55-0003-143 ST	12-35	55-0003-42 S	12-23
55-0003-110 ST	12-31	55-0003-144 S	12-35	55-0003-42 ST	12-23
55-0003-111 S	12-31	55-0003-144 ST	12-35	55-0003-43 S	12-23
55-0003-111 ST	12-31	55-0003-145 S	12-36	55-0003-43 ST	12-23
55-0003-112 S	12-31	55-0003-145 ST	12-36	55-0003-44 S	12-23
55-0003-112 ST	12-31	55-0003-146 S	12-36	55-0003-44 ST	12-23
55-0003-113 S	12-31	55-0003-146 ST	12-36	55-0003-45 S	12-23
55-0003-113 ST	12-31	55-0003-147 S	12-36	55-0003-45 ST	12-23
55-0003-114 S	12-31	55-0003-147 ST	12-36	55-0003-46 S	12-23
55-0003-114 ST	12-31	55-0003-148 S	12-36	55-0003-46 ST	12-23
55-0003-115 S	12-32	55-0003-148 ST	12-36	55-0003-47 S	12-23
55-0003-115 ST	12-32	55-0003-149 S	12-36	55-0003-47 ST	12-23
55-0003-116 S	12-32	55-0003-149 ST	12-36	55-0003-48 S	12-23
55-0003-116 ST	12-32	55-0003-15 S	12-20	55-0003-48 ST	12-23
55-0003-117 S	12-32	55-0003-15 ST	12-20	55-0003-49 S	12-23
55-0003-117 ST	12-32	55-0003-150 S	12-36	55-0003-49 ST	12-23
55-0003-118 S	12-32	55-0003-150 ST	12-36	55-0003-50 S	12-24
55-0003-118 ST	12-32	55-0003-151 S	12-36	55-0003-50 ST	12-24
55-0003-119 S	12-33	55-0003-151 ST	12-36	55-0003-51 S	12-24
55-0003-119 ST	12-33	55-0003-152 S	12-36	55-0003-51 ST	12-24
55-0003-12 S	12-20	55-0003-152 ST	12-36	55-0003-52 S	12-24
55-0003-12 ST	12-20	55-0003-16 S	12-20	55-0003-52 ST	12-24
55-0003-120 S	12-33	55-0003-16 ST	12-20	55-0003-53 S	12-24
55-0003-120 ST	12-33	55-0003-17 S	12-20	55-0003-53 ST	12-24
55-0003-121 S	12-33	55-0003-17 ST	12-20	55-0003-54 S	12-24
55-0003-121 ST	12-33	55-0003-18 S	12-20	55-0003-54 ST	12-24
55-0003-122 S	12-33	55-0003-18 ST	12-20	55-0003-55 S	12-24
55-0003-122 ST	12-33	55-0003-19 S	12-20	55-0003-55 ST	12-24
55-0003-123 S	12-33	55-0003-19 ST	12-20	55-0003-56 S	12-24
55-0003-123 ST	12-33	55-0003-20 S	12-20	55-0003-56 ST	12-24
55-0003-124 S	12-33	55-0003-20 ST	12-20	55-0003-57 S	12-24
55-0003-124 ST	12-33	55-0003-21 S	12-21	55-0003-57 ST	12-24
55-0003-125 S	12-33	55-0003-21 ST	12-21	55-0003-58 S	12-24
55-0003-125 ST	12-33	55-0003-22 S	12-21	55-0003-58 ST	12-24



Inhalt Instrumentenkatalog 09-0010-00 H

55-0003-59 S	12-25	55-0003-95 ST	12-29	55-0004-33 M	12-40
55-0003-59 ST	12-25	55-0003-96 S	12-29	55-0004-33 MT	12-40
55-0003-60 S	12-25	55-0003-96 ST	12-29	55-0004-34 M	12-40
55-0003-60 ST	12-25	55-0003-97 S	12-29	55-0004-34 MT	12-40
55-0003-61 S	12-25	55-0003-97 ST	12-29	55-0004-35 M	12-40
55-0003-61 ST	12-25	55-0003-98 S	12-29	55-0004-35 MT	12-40
55-0003-62 S	12-25	55-0003-98 ST	12-29	55-0004-36 M	12-40
55-0003-62 ST	12-25	55-0003-99 S	12-29	55-0004-36 MT	12-40
55-0003-63 S	12-25	55-0003-99 ST	12-29	55-0004-37 M	12-40
55-0003-63 ST	12-25	55-0004-01 M	12-37	55-0004-37 MT	12-40
55-0003-64 S	12-25	55-0004-01 MT	12-37	55-0004-38 M	12-40
55-0003-64 ST	12-25	55-0004-02 M	12-37	55-0004-38 MT	12-40
55-0003-65 S	12-25	55-0004-02 MT	12-37	55-0004-39 M	12-40
55-0003-65 ST	12-25	55-0004-03 M	12-37	55-0004-39 MT	12-40
55-0003-66 S	12-25	55-0004-03 MT	12-37	55-0004-40 M	12-40
55-0003-66 ST	12-25	55-0004-04 M	12-37	55-0004-40 MT	12-40
55-0003-67 S	12-25	55-0004-04 MT	12-37	55-0005-52	12-47
55-0003-67 ST	12-25	55-0004-05 M	12-37	55-0005-54	12-47
55-0003-68 S	12-26	55-0004-05 MT	12-37	55-0005-56	12-47
55-0003-68 ST	12-26	55-0004-06 M	12-37	55-0005-58	12-47
55-0003-69 S	12-26	55-0004-06 MT	12-37	55-0005-60	12-47
55-0003-69 ST	12-26	55-0004-07 M	12-37	55-0005-61	12-47
55-0003-70 S	12-26	55-0004-07 MT	12-37	55-0005-62	12-47
55-0003-70 ST	12-26	55-0004-08 M	12-37	55-0005-68	12-50
55-0003-71 S	12-26	55-0004-08 MT	12-37	55-0005-69	12-50
55-0003-71 ST	12-26	55-0004-09 M	12-37	55-0005-71	12-48
55-0003-72 S	12-26	55-0004-09 MT	12-37	55-0005-72	12-48, 12-50
55-0003-72 ST	12-26	55-0004-10 M	12-37	55-0005-73	12-48
55-0003-73 S	12-26	55-0004-10 MT	12-37	55-0005-74	12-48
55-0003-73 ST	12-26	55-0004-11 M	12-38	55-0005-78	12-50
55-0003-74 S	12-26	55-0004-11 MT	12-38	55-0006-01	12-43
55-0003-74 ST	12-26	55-0004-12 M	12-38	55-0006-01 T	12-43
55-0003-75 S	12-26	55-0004-12 MT	12-38	55-0006-02	12-43
55-0003-75 ST	12-26	55-0004-13 M	12-38	55-0006-02 T	12-43
55-0003-76 S	12-26	55-0004-13 MT	12-38	55-0006-03	12-43
55-0003-76 ST	12-26	55-0004-14 M	12-38	55-0006-03 T	12-43
55-0003-77 S	12-27	55-0004-14 MT	12-38	55-0006-04	12-43
55-0003-77 ST	12-27	55-0004-15 M	12-38	55-0006-04 T	12-43
55-0003-78 S	12-27	55-0004-15 MT	12-38	55-0006-05	12-43
55-0003-78 ST	12-27	55-0004-16 M	12-38	55-0006-05 T	12-43
55-0003-79 S	12-27	55-0004-16 MT	12-38	55-0006-06	12-43
55-0003-79 ST	12-27	55-0004-17 M	12-38	55-0006-06 T	12-43
55-0003-80 S	12-27	55-0004-17 MT	12-38	55-0006-07	12-44
55-0003-80 ST	12-27	55-0004-18 M	12-38	55-0006-07 T	12-44
55-0003-81 S	12-27	55-0004-18 MT	12-38	55-0006-08	12-44
55-0003-81 ST	12-27	55-0004-19 M	12-38	55-0006-08 T	12-44
55-0003-82 S	12-27	55-0004-19 MT	12-38	55-0006-09	12-44
55-0003-82 ST	12-27	55-0004-20 M	12-38	55-0006-09 T	12-44
55-0003-83 S	12-27	55-0004-20 MT	12-38	55-0006-10	12-44
55-0003-83 ST	12-27	55-0004-21 M	12-39	55-0006-10 T	12-44
55-0003-84 S	12-27	55-0004-21 MT	12-39	55-0006-11	12-44
55-0003-84 ST	12-27	55-0004-22 M	12-39	55-0006-11 T	12-44
55-0003-85 S	12-27	55-0004-22 MT	12-39	55-0006-12	12-44
55-0003-85 ST	12-27	55-0004-23 M	12-39	55-0006-12 T	12-44
55-0003-86 S	12-28	55-0004-23 MT	12-39	55-0006-18	12-42
55-0003-86 ST	12-28	55-0004-24 M	12-39	55-0006-18 T	12-42
55-0003-87 S	12-28	55-0004-24 MT	12-39	55-0006-19	12-42
55-0003-87 ST	12-28	55-0004-25 M	12-39	55-0006-19 T	12-42
55-0003-88 S	12-28	55-0004-25 MT	12-39	55-0006-20	12-42
55-0003-88 ST	12-28	55-0004-26 M	12-39	55-0006-20 T	12-42
55-0003-89 S	12-28	55-0004-26 MT	12-39	55-0006-21	12-42
55-0003-89 ST	12-28	55-0004-27 M	12-39	55-0006-21 T	12-42
55-0003-90 S	12-28	55-0004-27 MT	12-39	55-0006-22	12-42
55-0003-90 ST	12-28	55-0004-28 M	12-39	55-0006-22 T	12-42
55-0003-91 S	12-28	55-0004-28 MT	12-39	55-0006-23	12-42
55-0003-91 ST	12-28	55-0004-29 M	12-39	55-0006-23 T	12-42
55-0003-92 S	12-28	55-0004-29 MT	12-39	55-0006-24	12-42
55-0003-92 ST	12-28	55-0004-30 M	12-39	55-0006-24 T	12-42
55-0003-93 S	12-28	55-0004-30 MT	12-39	55-0006-25	12-42
55-0003-93 ST	12-28	55-0004-31 M	12-40	55-0006-25 T	12-42
55-0003-94 S	12-28	55-0004-31 MT	12-40	55-0006-28	12-41
55-0003-94 ST	12-28	55-0004-32 M	12-40	55-0006-28 T	12-41
55-0003-95 S	12-29	55-0004-32 MT	12-40	55-0006-29	12-41

55-0006-29 T	12-41	55-0031-12	12-14	55-0398-19	12-9
55-0006-30	12-41	55-0031-18	2-21	55-0399-16	12-9
55-0006-30 T	12-41	55-0032-15	12-13	55-0399-19	12-9
55-0006-31	12-41	55-0032-19	12-13	55-0583-14	4-6
55-0006-31 T	12-41	55-0033-15	12-14	55-1000-15 T	12-15
55-0006-32	12-41	55-0033-19	12-14	55-1000-18 T	12-15
55-0006-32 T	12-41	55-0323-22	12-4	55-1000-21 T	12-15
55-0006-33	12-41	55-0323-24	12-4	55-1001-15 T	12-15
55-0006-33 T	12-41	55-0324-22	12-4	55-1001-18 T	12-15
55-0006-34	12-41	55-0324-24	12-4	55-1001-21 T	12-15
55-0006-34 T	12-41	55-0325-24	12-4	55-1002-15 T	12-15
55-0006-35	12-41	55-0326-22	12-4	55-1002-18 T	12-15
55-0006-35 T	12-41	55-0327-22	12-4	55-1002-21 T	12-15
55-0006-40	12-46	55-0328-22	12-4	55-1003-15 T	12-15
55-0006-40 D	12-46	55-0329-22	12-4	55-1003-18 T	12-15
55-0006-40 DT	12-46	55-0331-23	12-5	55-1003-21 T	12-15
55-0006-40 T	12-46	55-0332-23	12-5	55-1010-15 T	12-11
55-0006-42	12-46	55-0333-23	12-5	55-1010-18 T	12-11
55-0006-42 D	12-46	55-0334-23	12-5	55-1010-21 T	12-11
55-0006-42 DT	12-46	55-0335-23	12-5	55-1011-15 T	12-11
55-0006-42 T	12-46	55-0336-23	12-5	55-1011-18 T	12-11
55-0006-44	12-46	55-0364-16	12-6	55-1011-21 T	12-11
55-0006-44 D	12-46	55-0364-18	12-6	55-1012-15 T	12-11
55-0006-44 DT	12-46	55-0364-20	12-6	55-1012-18 T	12-11
55-0006-44 T	12-46	55-0364-22	12-6	55-1012-21 T	12-11
55-0006-48	12-45	55-0364-24	12-6	55-1013-15 T	12-11
55-0006-48 T	12-45	55-0366-16	12-6	55-1013-18 T	12-11
55-0006-49	12-45	55-0366-18	12-6	55-1013-21 T	12-11
55-0006-49 T	12-45	55-0366-20	12-6	55-1020-15 T	12-16
55-0006-50	12-46	55-0366-22	12-6	55-1020-18 T	12-16
55-0006-50 D	12-46	55-0366-24	12-6	55-1020-21 T	12-16
55-0006-50 DT	12-46	55-0368-18	12-6	55-1021-15 T	12-16
55-0006-50 T	12-46	55-0370-12	12-7	55-1021-18 T	12-16
55-0006-52	12-46	55-0370-16	12-7	55-1021-21 T	12-16
55-0006-52 D	12-46	55-0370-16 Z	12-7	55-1022-15 T	12-16
55-0006-52 DT	12-46	55-0370-19	12-7	55-1022-18 T	12-16
55-0006-52 T	12-46	55-0371-12	12-7	55-1022-21 T	12-16
55-0006-54	12-46	55-0371-16	12-7	55-1023-15 T	12-16
55-0006-54 D	12-46	55-0371-16 Z	12-7	55-1023-18 T	12-16
55-0006-54 DT	12-46	55-0371-19	12-7	55-1023-21 T	12-16
55-0006-54 T	12-46	55-0372-12	12-7	55-1030-15 T	12-17
55-0006-58	12-45	55-0372-16	12-7	55-1030-18 T	12-17
55-0006-58 D	12-45	55-0373-12	12-7	55-1030-21 T	12-17
55-0006-58 DT	12-45	55-0373-16	12-7	55-1032-15 T	12-17
55-0006-58 T	12-45	55-0375-13	12-7	55-1032-18 T	12-17
55-0010-12	12-10	55-0376-12	12-7	55-1032-21 T	12-17
55-0010-15	12-10	55-0377-19	12-7	55-1034-15 T	12-17
55-0012-15 T	12-11	55-0380-23	12-8	55-1034-18 T	12-17
55-0012-18	12-10	55-0381-23	12-8	55-1034-21 T	12-17
55-0012-18 T	12-11	55-0382-17	12-8	55-1036-15 T	12-17
55-0012-21 T	12-11	55-0382-20	12-8	55-1036-18 T	12-17
55-0012-23	12-10	55-0382-23	12-8	55-1036-21 T	12-17
55-0013-15 T	12-11	55-0382-23 Z	12-8	60-0010-06	2-3
55-0013-18 T	12-11	55-0383-17	12-8	60-0010-07	2-3
55-0013-21 T	12-11	55-0383-20	12-8	60-0116-10	2-3
55-0015-12	12-10	55-0383-23	12-8	60-0116-20	2-3
55-0015-15	12-10	55-0383-25	12-8	60-0116-30	2-3
55-0017-18	12-10	55-0384-20	12-8	60-0116-40	2-3
55-0019-15	12-12	55-0384-23	12-8	60-0116-50	2-3
55-0019-18	12-12	55-0385-20	12-8	60-0116-60	2-3
55-0020-15	12-12	55-0385-23	12-8	60-0116-70	2-3
55-0020-18	12-12	55-0386-20	12-8	60-0116-80	2-3
55-0021-15	12-12	55-0386-23	12-8	60-0116-90	2-3
55-0021-18	12-12	55-0387-20	14-35	60-0122-01	2-3
55-0022-23	12-12	55-0388-20	14-35	60-0122-02	2-3
55-0028-12	12-13	55-0389-19	14-35	60-0122-03	2-3
55-0028-15	12-13	55-0396-20	14-36	60-0122-04	2-3
55-0028-19	12-13	55-0396-23	14-36	60-0125-01	2-4
55-0029-12	12-13	55-0397-17	14-36	60-0125-02	2-4
55-0030-00	2-21	55-0397-20	14-36	60-0125-03	2-4
55-0030-12	12-14	55-0397-22	14-36	60-0126-00	2-4
55-0030-15	12-14	55-0397-25	14-36	60-0126-01	2-4
55-0030-19	12-14	55-0398-16	12-9	60-0126-02	2-4



Inhalt Instrumentenkatalog 09-0010-00 H

60-0126-03	2-4	60-0360-08	1-8	61-0065-00	2-38
60-0126-04	2-4	60-0362-00	2-6	61-0066-00	2-38
60-0127-02	2-5	60-0362-02	2-6	61-0068-00	2-38
60-0127-04	2-5	60-0364-00	2-6	61-0080-00	2-38
60-0127-06	2-5	60-0364-02	2-6	61-0081-00	2-38
60-0127-08	2-5	60-0365-00	2-6	61-0082-00	2-38
60-0127-10	2-5	60-0370-00	2-1	61-0083-00	2-38
60-0127-12	2-5	60-0370-02	2-1	61-0105-21	2-41
60-0127-14	2-5	60-0371-00	2-1	61-0105-23	2-41
60-0127-16	2-5	60-0372-00	2-1	61-0223-00	2-37
60-0127-22	2-5	60-0373-00	2-1	61-0224-00	2-37
60-0127-24	2-5	60-0374-00	2-1	61-0226-00	2-37
60-0127-26	2-5	60-0380-00	2-2	61-0227-00	2-37
60-0127-28	2-5	60-0382-00	2-2	61-0228-00	2-37
60-0128-04	2-5	60-0383-00	2-2	61-0229-00	2-37
60-0128-06	2-5	60-0385-00	2-2, 10-6	61-2006-00	2-39
60-0128-22	2-5	60-0385-12	2-2	61-2007-00	2-39
60-0128-24	2-5	60-0850-00	2-32	61-2008-00	2-39
60-0128-26	2-5	60-0852-00	2-32	61-2010-00	2-39
60-0129-02	2-5	60-0856-00	2-32	61-2014-00	2-39
60-0129-04	2-5	60-0857-00	2-32	61-2014-00 S	2-39
60-0129-06	2-5	60-0858-00	2-32	61-2014-09	2-39
60-0129-08	2-5	60-0860-00	2-32	61-2014-10	2-39
60-0129-10	2-5	60-0862-00	2-32	61-2014-12	2-39
60-0129-12	2-5	60-0864-00	2-32	61-2018-00	2-39
60-0129-14	2-5	60-0865-00	2-32	61-2018-10	2-39
60-0135-00	2-2	60-0868-10	2-32	61-2018-12	2-39
60-0136-00	2-2	60-0868-15	2-32	61-2023-00	2-39
60-0137-01	2-2	60-0868-20	2-32	61-2023-00 S	2-39
60-0137-02	2-2	60-0868-25	2-32	61-2023-10	2-39
60-0137-03	2-2	60-0870-00	2-32	61-2023-12	2-39
60-0138-01	2-3	60-0870-01	2-32	61-2023-12 S	2-39
60-0138-02	2-3	60-0872-00	2-32	61-2027-00	2-39
60-0138-03	2-3	60-0872-01	2-32	61-2027-00 S	2-39
60-0145-00	2-7	60-0872-05	2-32	61-2027-10	2-39
60-0146-00	2-7	60-0877-00	2-36	61-2027-12	2-39
60-0147-00	2-7	60-0877-02	2-36	61-2031-00	2-39
60-0148-00	2-7	60-0877-05	2-36	61-2031-00 S	2-39
60-0150-00	2-7	60-0877-06	2-36	61-2031-10	2-39
60-0151-00	2-7	60-0877-08	2-36	61-2031-10 S	2-39
60-0152-00	2-7	60-0878-00	2-36	61-2031-12	2-39
60-0197-00	2-11	60-0878-02	2-36	61-2031-12 S	2-39
60-0197-01	2-11	60-0881-00	2-32	61-2035-00	2-39
60-0197-02	2-11	60-0883-00	2-32	61-2035-00 S	2-39
60-0206-00N	2-35	60-0887-00	2-32	61-2035-10	2-39
60-0208-00N	2-35	60-0888-00	2-32	61-2035-12	2-39
60-0209-00	2-35	60-0890-00	2-32	61-2040-00	2-39
60-0209-04	2-35	60-0891-00	2-32	61-2040-00 S	2-39
60-0217-00	3-18	60-0892-00	2-32	61-2040-10	2-39
60-0217-12	2-10, 5-6	60-0893-00	2-32	61-2040-10 S	2-39
60-0218-00	2-10, 3-18, 5-6	60-0894-00	2-34	61-2040-12	2-39
60-0219-00	2-10, 3-18, 5-6	60-0895-00	2-34	61-2040-12 S	2-39
60-0220-00	2-10, 3-18, 5-6	60-0896-00	2-34	61-2045-00	2-39
60-0221-00	2-10, 3-18, 5-6	60-0897-00	2-34	61-2045-10	2-39
60-0222-00	2-10, 3-18, 5-6	60-0901-00	2-34	61-2045-12	2-39
60-0223-00	2-10, 3-18	60-0902-08	2-34	61-2050-00	2-39
60-0223-04	5-6	60-0903-00	2-34	61-2050-00 S	2-39
60-0224-00	2-10, 3-18, 5-6	60-0903-15	2-34	61-2050-10	2-39
60-0225-00	2-10, 3-18, 5-6, 5-8	60-0905-00	2-33	61-2050-10 S	2-39
60-0225-02	2-10, 3-18, 5-6	60-0906-00	2-34	61-2050-12	2-39
60-0250-00	2-8	60-0925-00	2-33	61-2050-12 S	2-39
60-0251-00	2-8	60-0930-00	2-33	61-2060-00	2-39
60-0252-00	2-8	60-0938-00	2-35	61-2060-00 S	2-39
60-0252-01	2-8	60-0940-00	2-35	61-2060-10 S	2-39
60-0252-02	2-8	60-0950-00	2-34	61-2060-12 S	2-39
60-0253-00	2-8	60-0951-00	2-34	61-2070-00	2-39
60-0253-02	2-8	60-0952-00	2-34	61-2070-10	2-39
60-0255-00	2-8	60-0953-00	2-34	61-2070-12	2-39
60-0256-02	2-8	60-1000-00	2-33	61-2070-12 S	2-39
60-0256-04	2-8	60-1001-00	2-33	61-2106-00	2-39
60-0258-00	2-8	61-0060-00	2-38	61-2107-00	2-39
60-0259-00	2-8	61-0063-00	2-38	61-2108-00	2-39
60-0360-00	2-6	61-0064-00	2-38	61-2110-00	2-39



Inhalt Instrumentenkatalog 09-0010-00 H

HEIMOMED

61-2114-00	2-39	61-3250-12	2-40	63-0181-00	2-11
61-2114-10	2-39	61-3260-00	2-40	63-0182-00	2-11
61-2114-12	2-39	61-3260-00 S	2-40	63-0183-00	2-11
61-2118-00	2-39	61-3270-00	2-40	63-0184-00	2-11
61-2118-10	2-39	61-3270-00 S	2-40	63-0185-00	2-11
61-2118-12	2-39	61-3270-10	2-40	63-0190-00	2-9
61-2123-00	2-39	61-3270-12	2-40	63-0191-00	2-9
61-2123-10	2-39	61-3280-00	2-40	63-0192-00	2-9
61-2123-12	2-39	61-3540-00	2-40	63-0194-00	2-11
61-2127-00	2-39	61-3550-00	2-40	63-0197-00	2-11
61-2127-10	2-39	61-3560-00	2-40	63-0197-01	2-11
61-2127-12	2-39	61-3570-00	2-40	63-0197-02	2-11
61-2131-00	2-39	61-3580-00	2-40	63-0198-00	2-11
61-2131-10	2-39	61-3840-00	2-40	63-0200-00	2-9
61-2131-12	2-39	61-3850-00	2-40	63-0201-00	2-9
61-2135-00	2-39	61-3860-00	2-40	63-0202-00	2-9
61-2135-10	2-39	61-3870-00	2-40	63-0203-00	2-9
61-2135-12	2-39	61-3880-00	2-40	63-0204-00	2-9
61-2140-00	2-39	61-4440-00	2-40	63-0206-00	2-9
61-2140-10	2-39	61-4450-00	2-40	63-0207-00	2-9
61-2140-12	2-39	61-4460-00	2-40	63-0208-00	2-9
61-2145-00	2-39	61-4470-00	2-40	63-0209-00	2-9
61-2145-10	2-39	61-4480-00	2-40	63-0210-00	2-9
61-2145-12	2-39	61-5008-00	2-42	63-0211-00	2-9
61-2150-00	2-39	61-5010-00	2-42	63-0212-00	2-9
61-2150-10	2-39	61-5015-00	2-42	63-0213-00	2-9
61-2150-12	2-39	61-5023-00	2-42	63-0214-00	2-9
61-2160-00	2-39	61-5040-00	2-42	63-0215-00	2-9
61-2170-00	2-39	61-5060-00	2-42	63-0220-00	2-9
61-2170-10	2-39	61-5100-00	2-42	63-0221-00	2-9
61-2170-12	2-39	61-5108-00	2-42	63-0224-00	2-9
61-2206-00	2-39	61-5110-00	2-42	63-0225-00	2-9
61-2207-00	2-39	61-5111-00	2-42	63-0229-00	2-9
61-2208-00	2-39	61-5114-00	2-42	63-0230-00	2-9
61-2210-00	2-39	61-5116-00	2-42	63-0231-00	2-9
61-2214-00	2-39	61-5152-00	12-60	63-0304-00	2-23
61-2214-10	2-39	61-5212-00	2-42	63-0305-00	2-23
61-2214-12	2-39	61-5216-00	2-42	63-0308-00	2-24
61-2218-00	2-39	61-5219-00	2-42	63-0309-00	2-29
61-2218-10	2-39	61-5222-00	2-42	63-0310-00	2-29
61-2218-12	2-39	61-5225-00	2-42	63-0311-00	2-29
61-2223-00	2-39	61-5301-00	2-41	63-0312-00	2-29
61-2223-10	2-39	61-5322-02	2-41	63-0313-03	2-29
61-2223-12	2-39	61-5334-02	2-41	63-0313-04	2-29
61-2227-00	2-39	62-0100-00	2-32	63-0313-05	2-29
61-2227-10	2-39	62-0140-00	2-32	63-0313-06	2-29
61-2227-12	2-39	62-0150-00	2-32	63-0313-08	2-29
61-2231-00	2-39	62-0170-00	2-32	63-0313-10	2-29
61-2231-10	2-39	63-0145-00	2-29	63-0313-12	2-29
61-2235-00	2-39	63-0146-00	2-29	63-0313-15	2-29
61-2235-10	2-39	63-0147-00	2-29	63-0313-25	2-29
61-2235-12	2-39	63-0148-00	2-29	63-0313-30	2-29
61-2240-00	2-39	63-0150-00	2-11	63-0313-40	2-29
61-2240-10	2-39	63-0150-01	2-35	63-0313-50	2-29
61-2240-12	2-39	63-0150-02	2-35	63-0321-03	2-29
61-2245-00	2-39	63-0151-00	2-11	63-0321-04	2-29
61-2245-10	2-39	63-0152-00	2-11	63-0321-05	2-29
61-2245-12	2-39	63-0153-00	2-11	63-0321-06	2-29
61-2250-00	2-39	63-0154-00	2-11	63-0321-08	2-29
61-2250-10	2-39	63-0155-00	2-11	63-0321-10	2-29
61-2250-12	2-39	63-0160-00	2-11	63-0321-12	2-29
61-2260-00	2-39	63-0161-00	2-11	63-0321-15	2-29
61-2270-00	2-39	63-0162-00	2-11	63-0321-25	2-29
61-2270-10	2-39	63-0163-00	2-11	63-0321-30	2-29
61-2270-12	2-39	63-0164-00	2-11	63-0321-40	2-29
61-2940-00	2-40	63-0165-00	2-11	63-0321-50	2-29
61-2950-00	2-40	63-0170-00	2-11	63-0323-00	2-29
61-2960-00	2-40	63-0171-00	2-11	63-0324-00	2-29
61-2970-00	2-40	63-0172-00	2-11	63-0326-00	2-29
61-2980-00	2-40	63-0173-00	2-11	63-0327-02	2-29
61-3240-00	2-40	63-0174-00	2-11	63-0327-04	2-29
61-3250-00	2-40	63-0175-00	2-11	63-0328-00	2-29
61-3250-10	2-40	63-0180-00	2-11	63-0329-00	2-29



Inhalt Instrumentenkatalog 09-0010-00 H

63-0334-08	2-29	63-0408-40	2-28, 5-8	64-0057-04	3-22
63-0335-04	2-31	63-0412-40 L	2-27	64-0058-02	3-22
63-0335-06	2-31	63-0413-40 LL	2-27	64-0058-04	3-22
63-0335-08	2-31	63-0414-40 LL	2-27	64-0061-00	3-20
63-0337-35	2-31	63-0415-40 LL	2-27	64-0061-02	3-20
63-0337-40	2-31	63-0416-40 LL	2-27	64-0091-01	3-19
63-0337-45	2-31	63-0417-40 LL	2-27	64-0091-02	3-19
63-0337-50	2-31	63-0418-40 LL	2-27	64-0091-03	3-19
63-0338-00	2-31	63-0419-40 LL	2-27	64-0092-00	3-19
63-0338-12	2-35	63-0425-40	2-34	64-0098-00	3-19
63-0338-14	2-35	63-0430-40	2-28	64-0099-00	3-19, 5-19
63-0339-03	2-31	63-0430-41	2-28	64-0100-00	3-17
63-0339-04	2-31	63-0430-44	2-28	64-0101-00	3-17
63-0339-05	2-31	63-0430-46	2-28	64-0103-00	3-17
63-0339-06	2-31	63-0430-48	2-28	64-0104-00	3-17
63-0339-08	2-31	63-0700-40	2-36	64-0106-00	3-17
63-0339-10	2-31	63-0710-40	2-36	64-0108-00	3-17
63-0339-12	2-31	63-0711-40	2-36	64-0209-01	3-31, 5-15, 5-21
63-0339-30	2-30	63-0712-40	2-36	64-0209-02	3-21, 5-15, 5-21
63-0340-00	2-30	63-0713-40	2-36	64-0209-03	3-31, 5-15, 5-21
63-0340-00 HM	2-30	63-0714-40	2-36	64-0209-04	3-31, 5-15, 5-21
63-0340-01	2-30	63-0720-40	2-36	64-0211-05	5-20
63-0341-00	2-30	63-0725-40	2-36	64-0211-58	5-20
63-0342-01	2-31	63-0900-46	2-30	64-0211-59	5-20
63-0342-02	2-31	63-0900-25	2-30	64-0211-60	5-20
63-0342-03	2-31	63-1374-10	2-43	64-0213-50	5-21
63-0342-04	2-31	63-1374-15	2-43	64-0213-51	5-21
63-0342-10	2-30	63-1374-20	2-43	64-0213-55	5-21
63-0342-15	2-30	63-1374-30	2-43	64-0213-56	5-21
63-0342-20	2-30	63-1374-40	2-43	64-0214-04	5-21
63-0342-23	2-30	63-1374-50	2-43	64-0214-05	5-21
63-0342-25	2-30	63-1375-10	2-27	64-0214-06	5-21
63-0342-28	2-30	63-1375-15	2-27	64-0217-01	5-22
63-0346-10	2-30	63-1375-20	2-27	64-0217-11	5-22
63-0346-15	2-30	63-1375-25	2-27	64-0218-01	5-22
63-0346-20	2-30	63-1376-10	2-28	64-0218-02	5-22
63-0346-23	2-30	63-1376-15	2-28	64-0218-05	5-22
63-0346-25	2-30	63-1376-17	2-28	64-0218-20	5-22
63-0346-28	2-30	63-1376-20	2-28	64-0218-22	5-22
63-0352-10	2-30	63-1377-15	2-28	64-0218-26	5-22
63-0352-15	2-30	63-1377-17	2-28	64-0218-28	5-22
63-0352-20	2-30	63-1377-20	2-28	64-0218-30	5-22
63-0352-23	2-30	63-1378-10	2-27	64-0218-32	5-22
63-0352-25	2-30	63-1378-15	2-27	64-0218-36	5-22
63-0352-28	2-30	63-1378-20	2-27	64-0218-38	5-22
63-0355-01 HM	2-30	63-1378-25	2-27	64-0218-40	5-22
63-0355-03	2-30	64-0015-40	3-19	64-0218-41	5-22
63-0355-04	2-30	64-0016-40	3-19	64-0218-42	5-22
63-0355-05	2-30	64-0017-40	3-19	64-0398-00 H	3-28, 5-12
63-0356-02	2-31	64-0020-40	3-19	64-0399-00 H	3-28, 5-12
63-0356-06	2-31	64-0021-40	3-20	64-0401-00 H	3-28, 5-12, 10-3
63-0357-00	2-30	64-0022-40	3-20	64-0401-00 HD	3-30, 5-14
63-0360-00 L	2-27	64-0023-40	3-20	64-0401-00 HDO	3-30, 5-14
63-0362-00 LL	2-27	64-0027-40	3-20	64-0401-00 HDU	3-30, 5-14
63-0363-00 LL	2-27	64-0028-40	3-20	64-0401-00 HO	3-29, 5-13
63-0364-00 LL	2-27	64-0029-40	3-20	64-0401-00 HU	3-29, 5-13
63-0365-00 LL	2-27	64-0031-40	3-20	64-0402-00 H	3-28, 5-12, 10-3
63-0366-00 LL	2-27	64-0032-40	3-20	64-0402-00 HD	3-30, 5-14
63-0367-00 LL	2-27	64-0033-40	3-20	64-0402-00 HO	3-29, 5-13
63-0368-00 LL	2-27	64-0036-40	4-6, 3-19, 5-19	64-0402-00 HU	3-29, 5-13
63-0369-00 LL	2-27	64-0041-40	3-21	64-0403-00 H	3-28, 5-12, 10-3
63-0370-00 NL	2-28	64-0042-40	3-21	64-0403-00 HD	3-30, 5-14
63-0371-00 NL	2-28	64-0043-40	3-21	64-0403-00 HDO	3-30, 5-14
63-0374-00	2-28	64-0044-40	3-21, 9-2	64-0403-00 HDU	3-30, 5-14
63-0375-00	2-28	64-0051-40	3-21	64-0403-00 HO	3-29, 5-13
63-0376-00	2-28	64-0051-46	3-22	64-0403-00 HU	3-29, 5-13
63-0382-00 N	2-31, 7-7	64-0052-40	3-21	64-0404-00 H	3-28, 5-12, 10-3
63-0398-00L	2-27	64-0052-46	3-22	64-0404-00 HD	3-30, 5-14
63-0400-00	2-28	64-0053-00	3-21	64-0404-00 HDO	3-30, 5-14
63-0400-02	2-28	64-0053-06	3-22	64-0404-00 HDU	3-30, 5-14
63-0405-00	2-28	64-0054-00	3-21	64-0405-00 H	3-28, 5-12, 10-3
63-0406-00	2-28	64-0054-06	3-22	64-0406-00 H	3-28, 5-12, 10-3
63-0407-00	2-28	64-0057-02	3-22	64-0408-00 H	3-28, 5-12



Inhalt Instrumentenkatalog 09-0010-00 H

64-0409-00 H	3-28, 5-12	64-0576-22	5-4	64-0662-02	3-34
64-0411-00 H	3-28, 5-12, 10-3	64-0576-23	5-4	64-0663-00	3-34
64-0411-00 HD	3-30, 5-14	64-0577-00	5-4	64-0664-00	3-34
64-0411-00 HDO	3-30, 5-14	64-0578-00	5-3	64-0674-00	3-33
64-0411-00 HDU	3-30, 5-14	64-0579-00	5-3	64-0676-00	5-11
64-0411-00 HO	3-29, 5-13	64-0580-00	5-3	64-0680-00	3-33
64-0411-00 HU	3-29, 5-13	64-0581-00	5-3	64-0681-00	3-33
64-0412-00 H	3-28, 5-12, 10-3	64-0590-00	5-17	64-0786-00	3-50
64-0412-00 HD	3-30, 5-14	64-0590-02	5-17	64-0787-00	5-1
64-0412-00 HD	3-29, 5-13	64-0590-03	5-17	64-0787-01	5-1
64-0412-00 HU	3-29, 5-13	64-0591-00	5-23	64-0787-02	5-1
64-0413-00 H	3-28, 5-12, 10-3	64-0591-02	5-23	64-0787-03	5-1
64-0413-00 HD	3-30, 5-14	64-0591-03	5-23	64-0787-04	5-1
64-0413-00 HDO	3-30, 5-14	64-0594-00	5-6	64-0789-00	3-50
64-0413-00 HDU	3-30, 5-14	64-0594-04	5-6	64-0790-00	3-39
64-0413-00 HO	3-29, 5-13	64-0594-07	5-17	64-0795-00	3-39
64-0413-00 HU	3-29, 5-13	64-0594-10	5-17, 5-20	64-0806-00	3-39
64-0414-00 H	3-28, 5-12, 10-3	64-0594-12	5-17	64-0816-00	3-39
64-0414-00 HD	3-30, 5-14	64-0594-13	5-20	64-0937-00	3-18
64-0414-00 HDO	3-30, 5-14	64-0594-14	5-20	64-0942-00	3-18
64-0414-00 HDU	3-30, 5-14	64-0594-15	5-20	64-0945-00 N	3-18
64-0415-00 H	3-28, 5-12, 10-3	64-0594-18	5-20	64-0946-00	3-18
64-0416-00 H	3-28, 5-12, 10-3	64-0594-19	5-20	64-0947-00	5-24
64-0429-00 HR	3-28, 5-12	64-0594-22	5-20	64-0948-00	3-18, 3-43
64-0430-00 HR	3-28, 5-12	64-0594-23	5-20	64-0949-00	3-18
64-0431-00 HR	3-28, 5-12	64-0596-00	5-10	64-0950-00	3-43
64-0432-00 HR	3-28, 5-12	64-0599-01	5-11, 6-4	64-0955-00	3-43
64-0499-00	5-1	64-0599-02	5-11, 6-4	64-0966-30	3-43
64-0500-00	5-1	64-0599-03	5-11, 6-4	64-0966-36	3-43
64-0501-00	5-1	64-0599-04	5-11, 6-4	64-0966-40	3-43
64-0503-00	5-1	64-0601-00	3-31, 5-15	64-0970-00	3-43
64-0504-00	5-1	64-0602-00	3-31, 5-15	64-1020-00	3-50
64-0506-00	5-2	64-0603-00	3-31, 5-15	64-1021-00	3-50
64-0509-10	5-2	64-0604-00	3-31, 5-15	64-1022-00	3-50
64-0509-15	5-2	64-0605-00	3-31, 5-15	64-1023-00	3-50
64-0509-16	5-24	64-0606-00	3-31, 5-15	64-1030-00	3-50
64-0510-00	3-24	64-0607-00	3-31, 5-15	65-0090-00 S	3-21
64-0511-00	3-24	64-0611-00	3-31, 5-15	65-0091-00 S	3-21
64-0512-00	3-24	64-0612-00	3-31, 5-15	65-0095-01	3-22
64-0513-00	3-24	64-0613-00	3-31	65-0095-02	3-22
64-0514-00	3-24	64-0614-00	3-31, 5-15	65-0095-03	3-22
64-0515-00	3-24	64-0615-00	3-26	65-0095-04	3-22
64-0516-00	3-24	64-0616-00	3-26	65-0100-00	3-21
64-0521-00	5-1	64-0617-00	3-25	65-0101-00	3-21
64-0523-00	5-1	64-0618-00	3-25	65-0104-00	3-4
64-0524-00	5-1	64-0618-04	3-25	65-0105-00	3-4
64-0526-00	5-1	64-0619-00	3-25	65-0106-00	3-35
64-0528-00	5-1	64-0619-04	3-25	65-0106-01	3-35
64-0531-00	5-1	64-0620-00	3-26	65-0106-02	3-35
64-0533-00	5-1	64-0621-00	3-26	65-0107-00	3-35
64-0540-00	5-1	64-0625-00	3-25, 3-47	65-0108-00	3-32
64-0549-00	5-2	64-0628-00	3-25	65-0109-00	3-32
64-0550-00	5-2	64-0629-00	3-25	65-0109-10	3-32
64-0551-00	5-2	64-0632-00	3-26	65-0110-00	3-32
64-0552-00	5-2	64-0633-00	3-26	65-0111-00	3-32
64-0554-00	5-2	64-0634-00	3-26	65-0112-00	3-32
64-0555-00	5-2	64-0636-00	3-27, 5-16	65-0113-00	3-32
64-0556-00	5-2	64-0637-00	3-27, 5-16	65-0115-00	3-32
64-0557-00	5-2	64-0637-01	5-16	65-0116-00	3-32
64-0570-00	5-3	64-0638-00	3-27	65-0117-00	3-32
64-0575-00	3-34	64-0639-00	3-27	65-0118-00	3-32
64-0575-01	5-6, 5-19	64-0640-00	3-35	65-0119-00	3-32
64-0575-02	5-6, 5-19	64-0641-00	3-35	65-0120-00	3-41
64-0575-03	5-19	64-0650-00	3-35	65-0124-00	3-33
64-0575-04	5-19	64-0657-00	3-33	65-0125-00	3-33
64-0576-00	5-4	64-0658-00	3-33	65-0140-16	3-38
64-0576-11	5-4	64-0658-01	3-33	65-0144-04	3-38
64-0576-12	5-4	64-0658-02	3-33	65-0144-06	3-38
64-0576-13	5-4	64-0658-04	3-33	65-0147-04	3-38
64-0576-14	5-4	64-0660-00	3-34	65-0147-06	3-38
64-0576-15	5-4	64-0661-00	3-34	65-0147-07	3-38
64-0576-16	5-4	64-0662-00	3-34	65-0147-09	3-38
64-0576-21	5-4	64-0662-01	3-34	65-0147-12	3-38



Inhalt Instrumentenkatalog 09-0010-00 H

65-0148-04	3-38	65-0411-09	3-45	68-0220-00	7-19
65-0148-06	3-38	65-0412-01	3-46	68-0221-00	7-19
65-0148-07	3-38	65-0412-02	3-46	68-0222-00	7-19
65-0148-09	3-38	65-0413-01	3-45	68-0223-00	7-19
65-0148-12	3-38	65-0413-02	3-45	68-0224-00	7-19
65-0149-04	3-38	65-0413-03	3-45	68-0224-02	7-19
65-0149-06	3-38	65-0413-04	3-45	68-0225-00	7-19
65-0149-07	3-38	65-0413-05	3-45	68-0225-02	7-19
65-0149-09	3-38	65-0413-10	3-45	68-0238-00	7-19
65-0149-12	3-38	65-0414-00	3-44	68-0240-00	7-19
65-0150-03	3-38	65-0415-02	3-44	68-0241-00	7-19
65-0150-04	3-38	65-0415-04	3-44	68-0242-00	7-19
65-0151-02	3-38	65-0419-00	3-46	68-0245-00	7-16
65-0151-03	3-38	65-0420-00	3-48	68-0246-00	7-16
65-0151-03 S	3-38	65-0421-00	3-48	68-0270-00	6-1
65-0151-04	3-38	65-0425-00	3-48	68-0271-00	6-1
65-0151-06	3-38	65-0426-00	3-48	68-0272-00	6-1
65-0151-07	3-38	65-0428-00	3-49	68-0273-00	6-1
65-0151-09	3-38	65-0430-00	3-49	68-0274-00	6-1
65-0151-12	3-38	65-0430-02	3-49	68-0275-00	6-1
65-0152-11	3-38	65-0430-04	3-49	68-0290-00	6-1
65-0152-13	3-38	65-0430-06	3-49	68-0291-00	6-1
65-0152-15	3-38	65-0431-01	3-48	68-0292-00	6-1
65-0154-04	4-7, 3-38	65-0431-02	3-48	68-0293-00	6-1
65-0154-06	3-38	65-0431-03	3-48	68-0294-00	6-1
65-0154-07	4-7, 3-38	65-0431-04	3-48	68-0295-00	6-1
65-0154-09	4-7, 3-38	65-0436-00	3-47	68-0300-00	6-1
65-0154-12	4-7, 3-38	65-0438-00	3-47	68-0301-00	6-1
65-0160-00	3-41	65-0440-00	3-47	68-0302-00	6-1
65-0161-00	3-41	65-0441-00	3-47	68-0303-00	6-1
65-0162-00	3-41	68-0002-00	7-9	68-0304-00	6-1
65-0163-00	3-41	68-0008-00	7-10	68-0305-00	6-1
65-0164-00	3-41	68-0009-00	7-10	68-0306-00	6-2
65-0165-00	3-41	68-0009-01	7-10	68-0308-00	6-2
65-0169-00	3-40	68-0010-00	7-10	68-0309-00	6-2
65-0170-00	3-40	68-0011-00	7-16	68-0310-00	6-2
65-0171-00	3-40	68-0011-02	7-16	68-0311-00	6-2
65-0175-10	3-40	68-0012-01	6-2, 7-16	68-0312-00	6-2
65-0175-11	3-40	68-0014-00	7-16	68-0320-00	7-14
65-0175-13	3-40	68-0015-00	7-9	68-0320-13	7-14
65-0178-00	3-40	68-0016-00	7-9	68-0320-21	7-14
65-0179-00	3-40	68-0017-00	7-9	68-0320-22	7-14
65-0180-00	3-40	68-0020-00	7-15	68-0320-23	7-14
65-0185-00	3-42	68-0021-00	7-15	68-0330-00	6-4
65-0186-00	3-42	68-0025-00	7-14	68-0350-00	7-16
65-0187-00	3-42	68-0025-02	7-14	68-0967-40	7-15
65-0188-00	3-42	68-0026-00	7-14	68-0967-50	7-15
65-0200-00	3-39	68-0028-00	7-15	69-0100-00	8-2
65-0201-00	3-39	68-0030-00	7-15	69-0100-01	8-1
65-0202-00	3-39	68-0031-00	7-14	69-0100-02	8-1
65-0204-00	3-39	68-0035-00	7-14	69-0100-03	8-1
65-0301-00	3-49	68-0039-00	7-8	69-0100-04	8-1
65-0320-00	3-35	68-0041-00	7-8	69-0100-05	8-1
65-0325-00	3-35	68-0043-00	7-8	69-0100-06	8-1
65-0326-01	3-35	68-0045-00	7-8	69-0100-07	8-1
65-0326-02	3-35	68-0100-00	6-5	69-0101-00	8-2
65-0326-03	3-35	68-0101-00	6-5	69-0101-01	8-2
65-0328-00	3-35	68-0102-00	6-5	69-0102-02	8-1
65-0400-00	3-44	68-0103-00	6-5	69-0102-03	8-1
65-0401-00	3-44	68-0111-00	6-5	69-0102-04	8-1
65-0402-00	3-44	68-0112-01	6-5	69-0102-05	8-1
65-0408-00	3-46	68-0112-02	6-5	69-0102-06	8-1
65-0408-01	3-46	68-0112-03	6-5	69-0103-07	8-1
65-0408-04	3-46	68-0205-00	7-17	69-0104-06	8-1
65-0410-00	3-44	68-0205-02	7-17	69-0111-01	8-2
65-0411-01	3-45	68-0206-00	7-17	69-0111-02	8-2
65-0411-02	3-45	68-0210-00	7-18	69-0111-03	8-2
65-0411-03	3-45	68-0210-04	7-18	69-0115-00	8-2
65-0411-04	3-45	68-0211-00	7-18	69-0210-30	8-3
65-0411-05	3-45	68-0211-04	7-18	69-0210-31	8-3
65-0411-06	3-45	68-0215-00	7-18	69-0210-32	8-3
65-0411-07	3-45	68-0217-00	7-18	69-0211-30	8-3
65-0411-08	3-45	68-0218-00	7-18	69-0211-31	8-3

Inhalt Instrumentenkatalog 09-0010-00 H

69-0211-32	8-3	70-0016-20	9-1	73-0886-55	15-1
69-0212-30	8-3	70-0018-00	9-1	73-0890-45	15-1
69-0212-31	8-3	70-0019-00	9-1	73-0890-55	15-1
69-0212-32	8-3	70-0020-00	9-1	73-0892-45	15-1
69-0213-30	8-3	70-0022-00	9-4	73-0892-55	15-1
69-0213-31	8-3	70-0025-00	9-4	73-0894-45	15-1
69-0213-32	8-3	70-0026-00	9-4	73-0894-55	15-1
69-0225-30	8-3	70-0035-00	9-2	74-0205-00	10-4
69-0225-31	8-3	70-0037-00	9-2	74-0206-00	10-4
69-0225-32	8-3	70-0039-00	9-2	74-0210-20	10-4
69-0230-30	8-3	70-0118-00	3-42	74-0210-25	10-4
69-0230-31	8-3	70-0200-00	9-2	74-0210-30	10-4
69-0230-32	8-3	71-0021-00	9-2	74-0220-20	10-4
69-0720-30	8-3	71-0085-00	20-2	74-0220-25	10-4
69-0720-31	8-3	73-0410-35	15-2	74-0220-30	10-4
69-0720-32	8-3	73-0410-45	15-2	74-0250-20	10-4
69-0721-30	8-3	73-0410-55	15-2	74-0250-25	10-4
69-0721-31	8-3	73-0412-35	15-2	74-0250-30	10-4
69-0721-32	8-3	73-0412-45	15-2	74-0309-00	10-5
69-0722-30	8-3	73-0412-55	15-2	74-0310-00	10-5
69-0722-31	8-3	73-0414-35	15-2	74-0311-00	10-5
69-0722-32	8-3	73-0414-45	15-2	74-0315-00	10-5
69-0724-30	8-3	73-0414-55	15-2	74-0316-00	10-5
69-0724-31	8-3	73-0450-35	15-2	74-0317-00	10-5
69-0724-32	8-3	73-0450-45	15-2	74-0318-00	10-5
69-0726-30	8-3	73-0450-55	15-2	74-0320-00	10-5
69-0726-31	8-3	73-0452-35	15-2	74-0322-00	10-5
69-0726-32	8-3	73-0452-45	15-2	74-0324-00	10-5
69-0780-30	8-4	73-0452-55	15-2	74-0325-00	10-5
69-0780-31	8-4	73-0454-35	15-2	74-0326-00	10-5
69-0780-32	8-4	73-0454-45	15-2	74-0328-00	10-5
69-0782-30	8-4	73-0454-55	15-2	74-0330-00	10-5
69-0782-31	8-4	73-0710-25	15-1	74-0331-00	10-5
69-0782-32	8-4	73-0710-35	15-1	74-0332-00	10-5
69-0783-30	8-4	73-0730-25	15-1	74-0334-00	10-5
69-0783-31	8-4	73-0730-35	15-1	74-0336-00	10-5
69-0783-32	8-4	73-0732-25	15-1	74-0338-00	10-5
69-0784-30	8-4	73-0732-35	15-1	74-0340-00	10-5
69-0784-31	8-4	73-0790-25	15-1	74-0341-00	10-5
69-0784-32	8-4	73-0790-35	15-1	74-0342-00	10-5
69-0786-30	8-4	73-0792-25	15-1	74-0343-00	10-5
69-0786-31	8-4	73-0792-35	15-1	74-0344-00	10-5
69-0786-32	8-4	73-0793-25	15-1	74-0346-00	10-5
69-0814-00	8-3	73-0793-35	15-1	74-0360-00	10-1
69-0818-30	8-4	73-0794-25	15-1	74-0362-00	10-1
69-0819-30	8-4	73-0794-35	15-1	74-0364-00	10-1
69-0820-00	8-5	73-0796-25	15-1	74-0366-00	10-1
69-0821-00	8-5	73-0796-35	15-1	74-0367-00	10-1
69-0822-00	8-5	73-0812-25	15-1	74-0368-00	6-4
69-0823-00	8-5	73-0812-35	15-1	74-0369-00	6-4
69-0825-00	8-5	73-0814-25	15-1	74-0370-00	5-3, 10-1
69-0830-00	8-5	73-0814-35	15-1	74-0371-00	6-2
69-0831-00	8-5	73-0816-25	15-1	74-0374-00	5-3, 10-1
69-0834-00	8-5	73-0816-35	15-1	74-0375-00	6-3
69-0840-00	8-5	73-0850-45	15-1	74-0375-16	6-3
69-0841-00	8-5	73-0850-55	15-1	74-0377-00	6-3
69-0860-00	8-5	73-0862-45	15-1	74-0377-01	6-3
69-0970-00	8-6	73-0862-55	15-1	74-0377-02	6-3
69-0979-00	8-6	73-0864-45	15-1	74-0377-07	6-5
69-0980-00	8-6	73-0864-55	15-1	74-0377-08	6-5
69-0987-01	8-6	73-0866-45	15-1	74-0378-00	10-2
69-8602-00	8-6	73-0866-55	15-1	74-0379-00	10-2
69-8604-00	8-6	73-0876-45	15-1	74-0380-00	10-2
69-8605-04	8-7, 17-4	73-0876-55	15-1	74-0381-00	10-2
69-8605-05	8-7, 17-4	73-0878-45	15-1	74-0382-00	10-2
69-8690-00	8-6	73-0878-55	15-1	74-0383-00	10-2
69-8700-00	8-6	73-0879-45	15-1	74-0384-00	10-2
69-8702-00	8-6	73-0879-55	15-1	74-0385-00	10-2
69-8704-00	8-6	73-0882-45	15-1	74-0386-00	10-2
70-0008-00	9-4	73-0882-55	15-1	74-0387-00	10-2
70-0010-00	9-4	73-0884-45	15-1	74-0388-00	10-2
70-0015-00	9-1	73-0884-55	15-1	74-0389-00	10-2
70-0016-00	9-1	73-0886-45	15-1	74-0390-00	10-2



Inhalt Instrumentenkatalog 09-0010-00 H

74-0392-00	10-2	74-0583-00	7-5	87-1572-00	19-1
74-0408-00	10-2	74-0584-00	7-5	87-1573-00	19-1
74-0409-00	10-2	74-0585-00	7-5	87-1574-00	19-1
74-0410-00	10-2	74-0592-00	7-6	87-1575-00	19-1
74-0411-00	10-2	74-0593-00	7-6	87-1576-00	19-1
74-0412-00	10-2	74-0594-00	7-6	87-1580-00	19-2
74-0413-00	10-2	74-0595-00	7-6	87-1581-00	19-2
74-0414-00	10-2	74-0701-00	7-3	87-1582-00	19-1
74-0415-00	10-2	74-0702-00	7-3	87-1583-00	19-1
74-0416-00	10-2	74-0703-00	7-3	87-1585-00	19-1
74-0417-00	10-2	74-0704-00	7-3	87-1586-00	19-1
74-0418-00	10-2	74-0705-00	7-3	87-2012-00	19-2
74-0419-00	10-2	74-0706-00	7-3	87-5151-00	19-2
74-0420-00	10-2	74-0707-00	7-3	87-5152-00	19-2
74-0428-00	10-2	74-0828-00	10-2	87-5153-00	19-2
74-0429-00	10-2	74-0829-00	10-2	87-5154-00	19-2
74-0430-00	10-2	74-0830-00	10-2	87-5155-00	19-2
74-0431-00	10-2	74-0831-00	10-2	87-5156-00	19-2
74-0432-00	10-2	74-0832-00	10-2	87-5157-00	19-2
74-0433-00	10-2	74-0833-00	10-2	87-5158-00	19-2
74-0434-00	10-2	74-0834-00	10-2	87-5159-00	19-2
74-0435-00	10-2	74-0835-00	10-2	87-5161-00	19-2
74-0436-00	10-2	74-0836-00	10-2	87-5162-00	19-2
74-0437-00	10-2	74-0837-00	10-2	87-5493-00	19-2
74-0438-00	10-2	74-0838-00	10-2	87-5495-00	19-2
74-0439-00	10-2	74-0839-00	10-2	87-8060-00	19-2
74-0440-00	10-2	74-0840-00	10-2	88-505.0516.0	20-2
74-0442-00	10-2	74-7000-09	10-3	88-506.1540.0	20-2
74-0443-00	10-2	74-7000-10	10-3	88-508.0058.0	20-2
74-0444-00	10-2	75-0005-00	5-2	88-508.0566.0	20-2
74-0446-00	6-4	75-0006-00	2-41	88-508.0567.0	20-2
74-0447-00	10-7	80-0958-00	5-2	90-0280-04	8-7
74-0448-00	10-7	80-0958-13	5-2	90-0975-00	8-7
74-0449-00	10-7	80-0958-14	5-2	90-1615-00	8-7
74-0450-00	10-6	80-8431-00	3-50	90-1615-05	8-7
74-0453-00	3-11, 7-7, 10-6	80-8480-00	5-16	91-0459-30	19-5
74-0454-00	3-11, 7-7, 10-6	81-0471-00	20-2	91-0459-31	19-5
74-0455-00	7-7, 10-6	81-0471-08	19-2	91-0459-50	19-5
74-0500-00	7-1	85-2093-01	3-50	91-0459-52	19-5
74-0500-02	7-1	85-2093-02	3-50	91-0459-80	19-5
74-0500-04	7-1	85-2093-03	3-50	91-0459-82	19-5
74-0505-00	7-1	85-2794-00	7-7	91-0488-00	19-3
74-0505-04	7-2	87-0211-00	19-2	91-0488-30	19-3
74-0505-12	7-2	87-0212-00	19-2	91-0488-50	19-3
74-0505-14	7-2	87-1041-00	2-2	91-0488-70	19-3
74-0520-00	7-1	87-1521-00	19-1	91-0499-00	19-3
74-0526-00	7-2	87-1522-00	19-1	91-0499-10	19-3
74-0527-00	7-2	87-1523-00	19-1	91-0499-13	19-3
74-0528-00	7-2	87-1524-00	19-1	91-0499-17	19-3
74-0529-00	7-2	87-1531-00	19-1	91-0499-25	19-3
74-0540-00	7-4	87-1532-00	19-1	91-0499-30	19-3
74-0541-00	7-4	87-1533-00	19-1	91-0499-50	19-3
74-0542-00	7-4	87-1534-00	19-1	91-0499-70	19-3
74-0543-00	7-4	87-1535-00	19-1	91-0500-00	19-3
74-0544-00	7-4	87-1536-00	19-1	91-0500-10	19-3
74-0545-00	7-4	87-1538-00	19-1	91-0500-13	19-3
74-0552-00	7-6	87-1541-00	19-1	91-0500-17	19-3
74-0553-00	7-6	87-1541-01	19-1	91-0500-25	19-3
74-0554-00	7-6	87-1542-00	19-1	91-0500-30	19-3
74-0555-00	7-6	87-1542-01	19-1	91-0500-50	19-3
74-0561-00	7-3	87-1543-00	19-1	91-0500-70	19-3
74-0562-00	7-3	87-1543-01	19-1	91-0501-00	19-3
74-0563-00	7-3	87-1544-00	19-1	91-0501-30	19-3
74-0564-00	7-3	87-1544-01	19-1	91-0501-50	19-3
74-0565-00	7-3	87-1545-00	19-1	91-0501-70	19-3
74-0571-00	7-4	87-1545-01	19-1	91-0511-30	19-4
74-0572-00	7-4	87-1546-00	19-1	91-0511-481	19-4
74-0573-00	7-4	87-1546-01	19-1	91-0513-02	19-4
74-0574-00	7-4	87-1547-00	19-1	91-0513-03	19-4
74-0575-00	7-4	87-1548-00	19-1	91-0513-06	19-4
74-0575-13	7-4	87-1549-00	19-1	91-0513-07	19-4
74-0581-00	7-5	87-1550-00	19-1	91-0513-08	19-4
74-0582-00	7-5	87-1571-00	19-1	91-0513-60	19-4



HEIMOMED

Inhalt Instrumentenkatalog 09-0010-00 H

91-0523-60	19-4
91-0570-30	19-5
91-0570-31	19-5
91-0570-50	19-5
91-0570-52	19-5
91-0570-80	19-5
91-0570-82	19-5
91-0606-01	19-4
91-0606-02	19-4
91-0606-03	19-4
91-0706-00	19-3
91-0708-00	19-3
91-0715-00	19-3
91-0716-00	19-3
91-8010-02	20-3
99-2500-00	20-2

Reflektoren
Reflectors



Reflektoren

Stirnreflektoren

Head Mirrors



Spiegel mit Durchmesser 100 mm
sind auf Anfrage lieferbar /
mirrors 100 mm on request

**Stirnreflektor komplett mit breitem Kunststoffband,
mit Rostocker Gelenk**

head mirror with band of plastic, Rostock joint,

Spiegel / mirror 90 mm

11-1048-19

Kunststoffband breit, mit Rostocker Gelenk, alleine

band of plastic, Rostock joint, only

11-1052-00



**Stirnreflektor komplett mit breitem Celluloidband,
mit Rostocker Gelenk**

head mirror with band of celluloid, Rostock joint,

Spiegel / mirror 90 mm

11-1048-18

Celluloidband breit, mit Rostocker Gelenk, alleine

band of celluloid, Rostock joint, only

11-1048-00



**Stirnreflektor komplett mit breitem Kunststoffband,
mit Doppelgelenk**

head mirror with band of plastic, double joint,

Spiegel / mirror 90 mm

11-1047-19

Kunststoffband breit, mit Doppelgelenk, alleine

band of plastic, double joint, only

11-1051-00



Doppelgelenk alleine

double joint only

11-1041-00



**Stirnreflektor komplett mit breitem Celluloidband,
mit Doppelgelenk**

head mirror with band of celluloid, double joint,

Spiegel / mirror 90 mm

11-1047-00

Celluloidband breit, mit Doppelgelenk, alleine

band of celluloid, double joint, only

11-1050-00

Stirnreflektoren Head Mirrors

Spiegel mit Durchmesser 100 mm
sind auf Anfrage lieferbar
mirrors 100 mm on request

Stirnreflektor komplett
mit schmalen Kunststoffband weiß
mit Rostocker Gelenk
Head mirror with white band of
plastic, Rostock joint
Spiegel / mirror 90 mm
11-1043-19

Kunststoffband weiß, schmal,
mit Rostocker Gelenk, alleine
band of black plastic
Rostock joint, only
11-1043-02



Stirnreflektor komplett
mit schmalen Kunststoffband schwarz,
mit Rostocker Gelenk
head mirror with black band of plastic,
Rostock joint,
Spiegel / mirror 90 mm
11-1043-18

Kunststoffband schwarz, schmal, mit
Rostocker Gelenk, alleine
band of black plastic, Rostock joint,
only
11-1043-01



Stirnreflektor komplett mit Band
(Kunststoffband, weiß) mit Doppelgelenk
head mirror with band
(band of white plastic), double joint,
Spiegel / mirror 90 mm
11-1046-00

Kunststoffband (weiß), schmal,
mit Doppelgelenk, alleine
band of plastic (white)
double joint, only
11-1045-00



Stirnreflektor komplett mit Band
(Kunststoffband, schwarz) mit Doppelgelenk
head mirror with band
(band of black plastic), double joint
Spiegel / mirror 90 mm
11-1046-02

Kunststoffband (schwarz) schmal,
mit Doppelgelenk, alleine
band of plastic (black)
double joint, only
11-1044-00

Stirnreflektoren
Head Mirrors



Spiegel / 90 mm
auswechselbar, alleine
mirror interchangeable, only
11-1030-00

Spiegel / 100 mm
auswechselbar, alleine
mirror interchangeable, only
11-1031-00



Spiegel / 90 mm
mit Rostocker Gelenk
auswechselbar, alleine
mirror interchangeable,
Rostock joint, only
11-1032-00

Spiegel / 100 mm
mit Rostocker Gelenk
auswechselbar, alleine
mirror interchangeable,
Rostock joint, only
11-1033-00



Spiegel 90 mm, mit Metallfassung, alleine
mirror 90 mm, with metal coating, only
11-1036-02

Stirnlampen Head lamps



Stirnlampe „Licht + Freiheit“

1 LED
head lamp
11-1415-01
3 x 1,5 V Batterien
80 Std. Brenndauer
80 hrs. life

Stirnlampe „Licht + Freiheit“

3 LED
head lamp
11-1415-03
3 x 1,5 V Batterien
80 Std. Brenndauer
80 hrs. life



Stirnlampen mit konventioneller Beleuchtung

head lamp
convent. illumination

Stirnlampe nach Clar mit breitem Kunststoffband und 1 Ersatzbirne

Clar head lamp
plastic band and 1 spare bulb
11-1071-00

Stirnlampe nach Clar mit breitem Celluloidband und 1 Ersatzbirne

Clar head lamp
celluloid band and 1 spare bulb
11-1071-01

Ersatz-Birnen

spare bulb
11-8760-00

Stirnlampen
Head lamps



1

Stirnlampen mit Kaltlichtbeleuchtung
Head lamp cold light illumination

1 Kaltlicht-Stirnlampe
1 Cold light Headlamp
nach Clar mit Kabel 230 mm
Stirnreifen mit Kopfbügel
und Schnellverschluß
Clar halogen head light with cable 230 mm,
crossband and easily adjustable headband
11-1400-00



2

2 Kaltlicht-Stirnlampe
2 Cold light Headlamp
HEIMOMED >2000<
Kabel links geführt mit HEIMOMED
Ansatz, Gerätestecker gerade
Stirnreifen mit Schnellverschluß
Light guide left with HEIMOMED
connector, plug straight
Head band easily adjustable
11-1421-01

dto. Kabel rechts geführt,
light guide right
11-1421-02

dto. Kabel links geführt,
Gerätestecker 100° abgewinkelt
light guide left
plug angled 100°
11-1421-04

dto. Kabel rechts geführt
Gerätestecker 100° abgewinkelt
light guide right
plug angled 100°
11-1421-05

Kaltlichtprojektor Cold light Projector



ADLATUS Kaltlichtprojektor

11-1505-00
Klares, weißes, schattenarmes Licht
Farbtemperatur 3500 K
150 Watt Halogenlampe
Stufenlose Helligkeitseinstellung
1 Lichtentnahme-Anschluß
Netzanschluß 230 V / 50 Hz
Kompaktes Design 190x180x150 (HxBxT)
Gewicht 3880 g

clear, white light, poor of shadow
3500 K colour temperature
150 Watt halogen lamp
continuously adjustable light control
1 light connection
230 V / 50 Hz mains connection
compact design 190x180x150
weight 3880 g

dto.,
für Wolf-Ansatz
w. Wolf connector

11-1505-02

ADLATUS Kaltlichtprojektor
Ersatzbirne (VE=5 Stück)
spare bulb (packing unit = 5 pcs)
11-8034-00



VISITAT Kaltlichtprojektor
mit HEIMOMED Ansatz
VISITAT Halogen projector
w. HEIMOMED connector
35 W / 230 V AC
Maße / size
H x B x T / h x w x d
60 x 112 x 180 mm
11-1506-00

Lupenbrille
Binocular loupe

Art. Nr. / Ord. no:	11-1012-34
Vergrößerung: / magnification	2,3x
Arbeitsabstand: / working distance	340 mm
Sichtfeld: / field of view	110 mm
Gewicht: / weight	46g

Art. Nr. / Ord. no:	11-1012-45
Vergrößerung: / magnification	2,3x
Arbeitsabstand: / working distance	450 mm
Sichtfeld: / field of view	130 mm
Gewicht: / weight	46g



HNO-Set im Etui
ENT set in case
11-8191-00



**Mini-Ophthalmoskop
2000** 2,5 V mit Batteriegriff
Mini ophthalmoscope
2000
2,5 V with battery grip
11-8198-01



Mini-Otoskop 2000
2,5 V, mit Batteriegriff
Mini otoscope 2000
2,5 V, with battery grip
11-8188-00



Lichtquelle 6 Volt Light source, 6 V

Accu-Box für die Hausbesuche,
an der Kleidung tragbar, für Stirnlampen mit
konventioneller Beleuchtung, 6 V, mit Ladegerät
Pocket accu for home visits,
wearable at cloth, with conventional illumination,
6 V, with charging station
11-1088-00



Steckdosentransformator
für Stirnlampen
für konventionelle Beleuchtung, 6 V
Plug transformer
for Headlamps
with conventional illumination, 6 V
11-1087-00



Tischtransformator
für Stirnlampen
mit konventioneller Beleuchtung, 6 V
Desk transformer
for head lamps
with conventional illumination, 6 V
11-1085-00



Lichtquelle
für die Nystagmusbrille,
Regeltransformator
Light source
for nystagmus spectacle,
control transformer
60-0360-08

Otologie
Otology

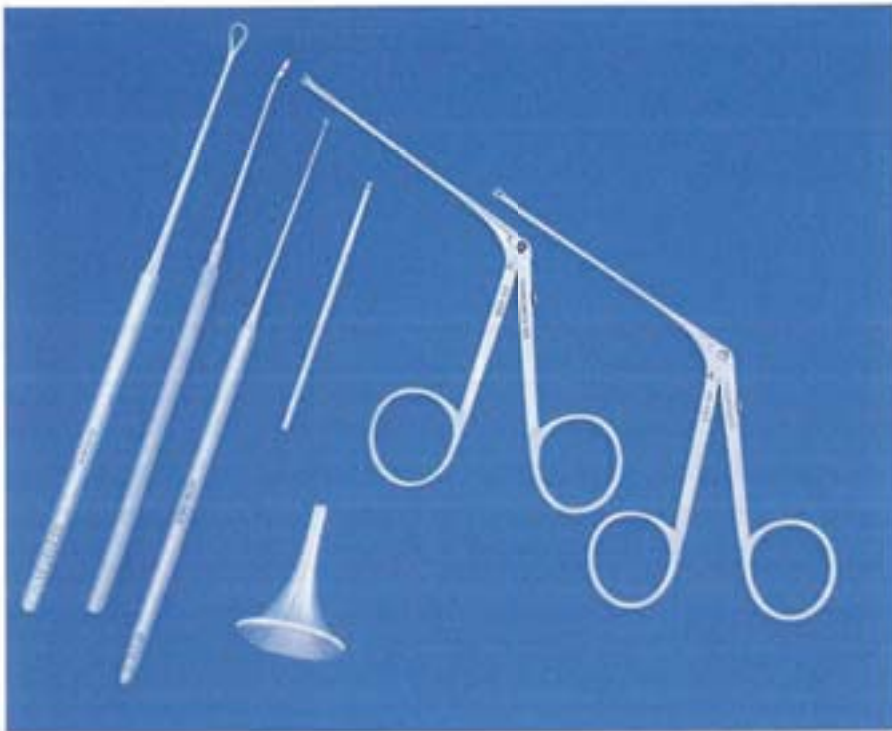

Zerstäuber
Atomiser

**Wagner Zerstäuber
ohne Ball**
Wagner atomiser
without ball



für Nase
for nose
48-1010-00

für Kehlkopf
for larynx
48-1011-00A

für Rachen
for throat
48-1011-00B

**Metallfuß
für Zerstäuber**
Metal base
48-1011-00F



Gebläse für Spray
Blower for spray
48-1031-00



Halbgebläse
Halfblower
48-1030-00

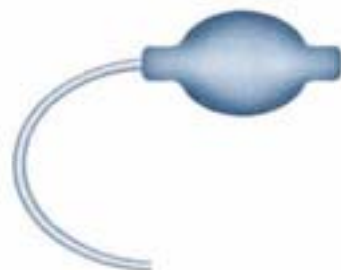

**Zerstäuber
mit Schauglas**
Atomiser with
glass
12 ccm



für Nase / nose
48-1012-00

für Kehlkopf / larynx
48-1013-00

für Rachen / throat
48-1014-00

**Politzer-Ballon
alleine**
Poltzer Balloon
only
60-0370-00



**Politzer-Ballon
komplett m. 3 Oliven**
Poltzer Balloon
complete w. 3 olives
60-0370-02

**Politzer-Oliven
Doppelkonus**
Poltzer olives
double cone
60-0371-00
60-0372-00
60-0373-00
60-0374-00

Olive 18 mm
Olive 20 mm
Olive 22 mm
Doppelkonus





Kabierske - Pulverbläser
Kabierske powder blower
30 cc
60-0385-00



Jansen Hörschlauch
Jansen otoscope
60-0380-00

Ersatzball alleine mit Ventil
60-0385-12



Barany Lärmtrommel mit Ohrmuschel
Barany noise apparatus with concha
60-0136-00



Gummiball für Tubenkatheter
Rubberball for catheters
60-0137-01 1 1/2 Unzen
60-0137-02 2 Unzen
60-0137-03 2 1/2 Unzen



Stoppuhr
Stopwatch
87-1041-00



Ohrspritze
Earsyringe
50 ml 60-0382-00
100 ml 60-0383-00

Barany Lärmtrommel mit Ohrolive
Barany noise apparatus with ear olive
60-0135-00

Ohrtrichter aus Edelstahl
Ear specula, stainless steel



Fig.	Art.-Nr.	ID mm
* 000	60-0116-10	1.0
○ 00	60-0116-20	2.0
○ 0	60-0116-30	3.0
○ 1	60-0116-40	4.0
○ 2	60-0116-50	5.0
○ 4	60-0116-60	6.0
○ 6	60-0116-70	7.0
○ 7	60-0116-80	8.0
○ 8	60-0116-90	9.0

o. Abb.: Holmgreen Ohrtrichter
wie foto: Holmgreen ear specula

ID 6 mm 60-0010-06
ID 7 mm 60-0010-07



Gruber - Ohrtrichter
Gruber ear specula

○ 1	60-0122-01
○ 2	60-0122-02
○ 3	60-0122-03
○ 4	60-0122-04

Tubenkatheter
Eustachian catheter



1	60-0138-01
2	60-0138-02
3	60-0138-03

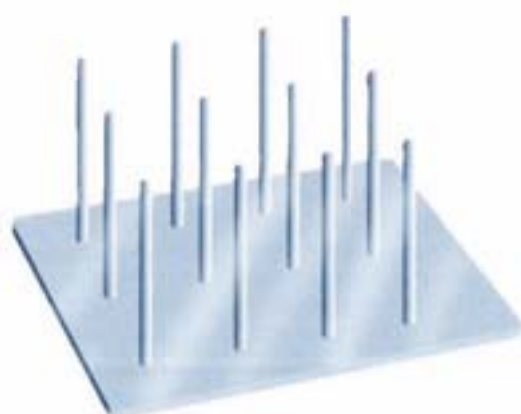

Ohrtrichter - Ständer Edelstahl
Ear specula rack, High-grade steel

- | | |
|------------|--------------------|
| 60-0125-01 | für 12 Ohrtrichter |
| 60-0125-02 | für 18 Ohrtrichter |
| 60-0125-03 | für 24 Ohrtrichter |



Brünings - Ohrtupe komplett Edelstahl
Brüenings ear magnifier complete Stainless Steel
60-0126-00

Ohrtrichter
Ear Specula

- | | | |
|--|--------|------------|
|  | 6 mm | 60-0126-01 |
|  | 7,5 mm | 60-0126-02 |
|  | 8,2 mm | 60-0126-03 |
|  | 10 mm | 60-0126-04 |

Stimmgabeln
Tuning forks



A1	440	60-0127-02
C	128	60-0127-04
C	256	60-0127-06
C	512	60-0127-08
C	1024	60-0127-10
C	2048	60-0127-12
C	4096	60-0127-14



Stimmgabel mit
Schwingungsdämpfer
Tuning fork, with damp

C 128	60-0128-04
C 256	60-0128-06



Stimmgabel aus Alu
mit Schwingungsdämpfer
Tuning fork (alu) with damp

C 64	60-0128-22
C 128	60-0128-24
C 256	60-0128-26



Stimmgabel aus Alu
Tuning fork (alu)

A1 440	60-0127-16
C 512	60-0127-22
C 1024	60-0127-24
C 2048	60-0127-26
C 4096	60-0127-28



Stimmgabel mit Fuß
Tuning fork with stem

A1 440	60-0129-02
C 128	60-0129-04
C 256	60-0129-06
C 512	60-0129-08
C 1024	60-0129-10
C 2048	60-0129-12
C 4096	60-0129-14

Nystagmusbrillen
Nystagmus spectacles



**Nystagmusbrille
nach Frenzel
mit festen Gläsern**
Nystagmus spectacles
with fixed lenses
60-0360-00

Nystagmusbrille aufklappbar
Nystagmus spectacles
nach Frenzel 60-0362-00
nach Blessing 60-0362-02

**Nystagmusbrille
nach Blessing
mit Batteriegriff**
Nystagmus spectacle
with battery grip
60-0364-02

**Nystagmusbrille
nach Frenzel
mit Batteriegriff**
Nystagmus spectacle
w. battery grip
60-0364-00

o. Abb.: Ersatzbirne
für Nystagmusbrille
spare bulb
60-0365-00



Tamponadenzangen / Tampon forceps
Polypenschnürer / Ear snare



Lange-Wilde
Ohrpolypenschnürer
Ear snare
170 mm
60-0147-00

- 1 Krause
Ohrpolypenschnürer
Ear snare
160 mm
60-0145-00
- 2 Krause-Voss
Ohrpolypenschnürer
Ear snare
160 mm
60-0146-00



Polypenschlingen
Ear snare wire
0,2 mm
60-0148-00



Littauer
Ohrtamponadenzange
Ear tampon forceps
120 mm, fein
60-0152-00



Hartmann
Ohrtamponadenzange
Ear tampon forceps
standard, 140 mm
60-0151-00



Hartmann
Ohrtamponadenzange
Ear tampon forceps
fein, 120 mm
60-0150-00

Paracentesenadel Tympanum perforator



Hartmann
Paracentesenadel mit
auswechselbarer Klinge
Tympanum perforator
interchangeable blade
Griff / grip 60-0255-00

Griff komplett m. Klinge
Grip complete w. blades
1 lanzettenförmig 60-0256-02
2 messerförmig 60-0256-04



Politzer
Paracentesenadel
Tympanum perforator
160 mm
60-0253-00 (v) vertikal
60-0253-02 (h) horizontal



Beyer
Paracentese-
nadel
Tympanum
perforator
100 mm
60-0258-00 (h)
60-0259-00 (v)



**Paracentese-
nadel**
umsteckbar
Tympanum
perforator
120 mm
60-0251-00



Lucae
Paracentesenadel
Tympanum perforator
schraubbar / screwable
190 mm
60-0250-00



Lucae
Paracentesenadel
Tympanum perforator
180 mm
60-0252-00 (v)
60-0252-02 (h) fein / fine
f. Kinder / for children
160 mm (fein / fine)
60-0252-01 (v)

Cerumenhäkchen
Cerumen hooklet

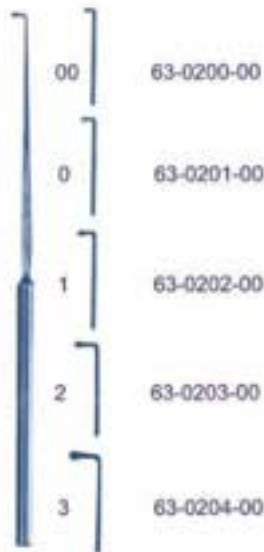

Lucae
Cerumenhäkchen
Cerumen hooklet
140 mm

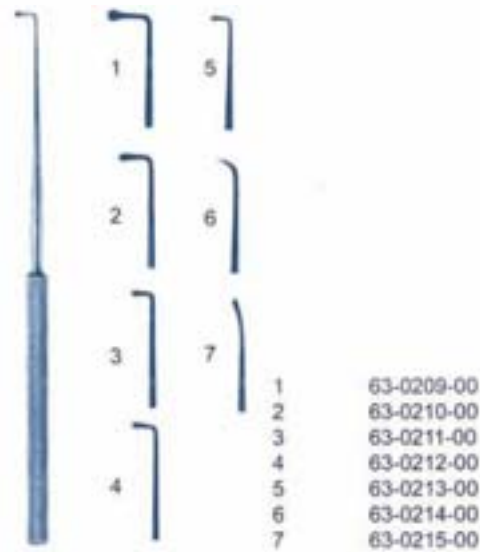

Wagener
Cerumenhäkchen
Cerumen hooklet
140 mm

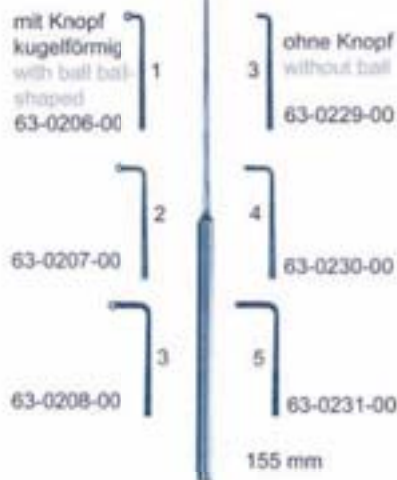
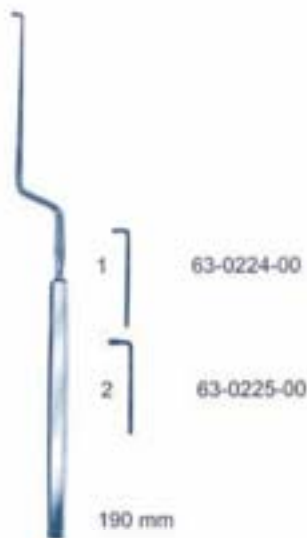
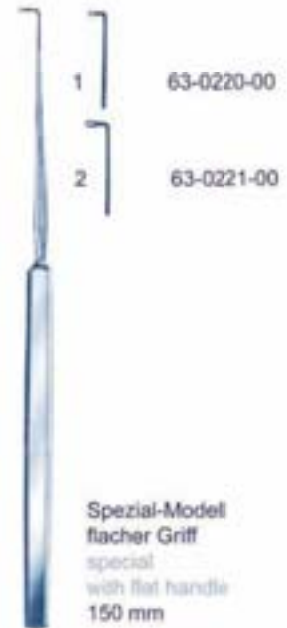

Watteträger Cotton applicator

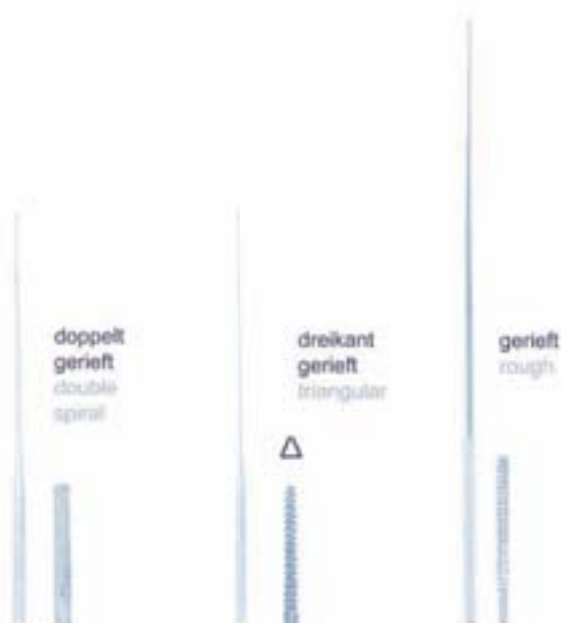

	doppelt gerieft biegsam double spiral pliable	dreikant gerieft triangular	gerieft rough
7,5 cm		1,0 mm 60-0222-00	1,0 mm 60-0223-00
12,0 cm			0,8 mm 60-0217-12
12,0 cm	1,2 mm 60-0224-00	1,2 mm 60-0219-00	1,2 mm 60-0218-00
14,0 cm	1,2 mm 60-0225-02		
16,0 cm	1,2 mm 60-0225-00	1,2 mm 60-0221-00	1,2 mm 60-0220-00

Ohrküretten Ear cures

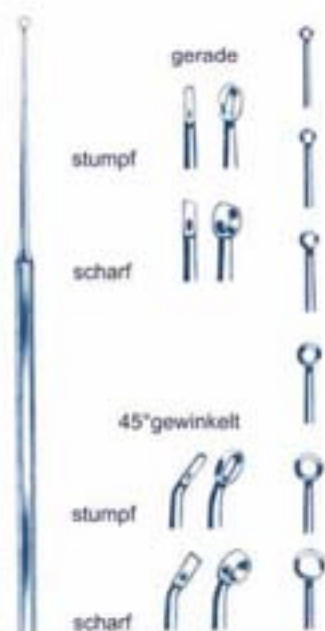

Buck
Ohrküretten
Ear curette
145 mm

	gerade straight	stumpf blunt	scharf sharp
000	63-0170-00		63-0180-00
00	63-0171-00		63-0181-00
0	63-0172-00		63-0182-00
1	63-0173-00		63-0183-00
2	63-0174-00		63-0184-00
3	63-0175-00		63-0185-00
45°		stumpf blunt	scharf sharp
000		63-0150-00	63-0160-00
00		63-0151-00	63-0161-00
0		63-0152-00	63-0162-00
1		63-0153-00	63-0163-00
2		63-0154-00	63-0164-00
3		63-0155-00	63-0165-00

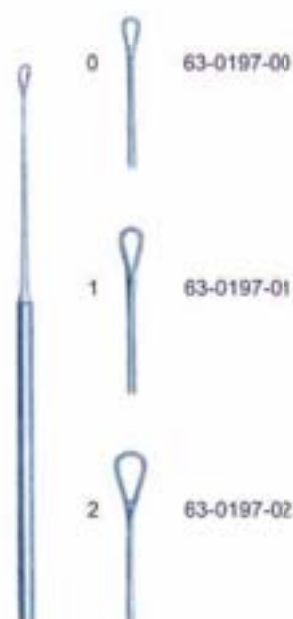

Weber
Loch Ohrschlinge
Ear loop
145 mm



Zaufal
Ohrhebel
Ear hook
150 mm
63-0194-00



Langerbeck
Ohrschlinge
Ear loop
150 mm
63-0198-00

Klingenhalter / Scalpel handels Skalpellklingen / Blades

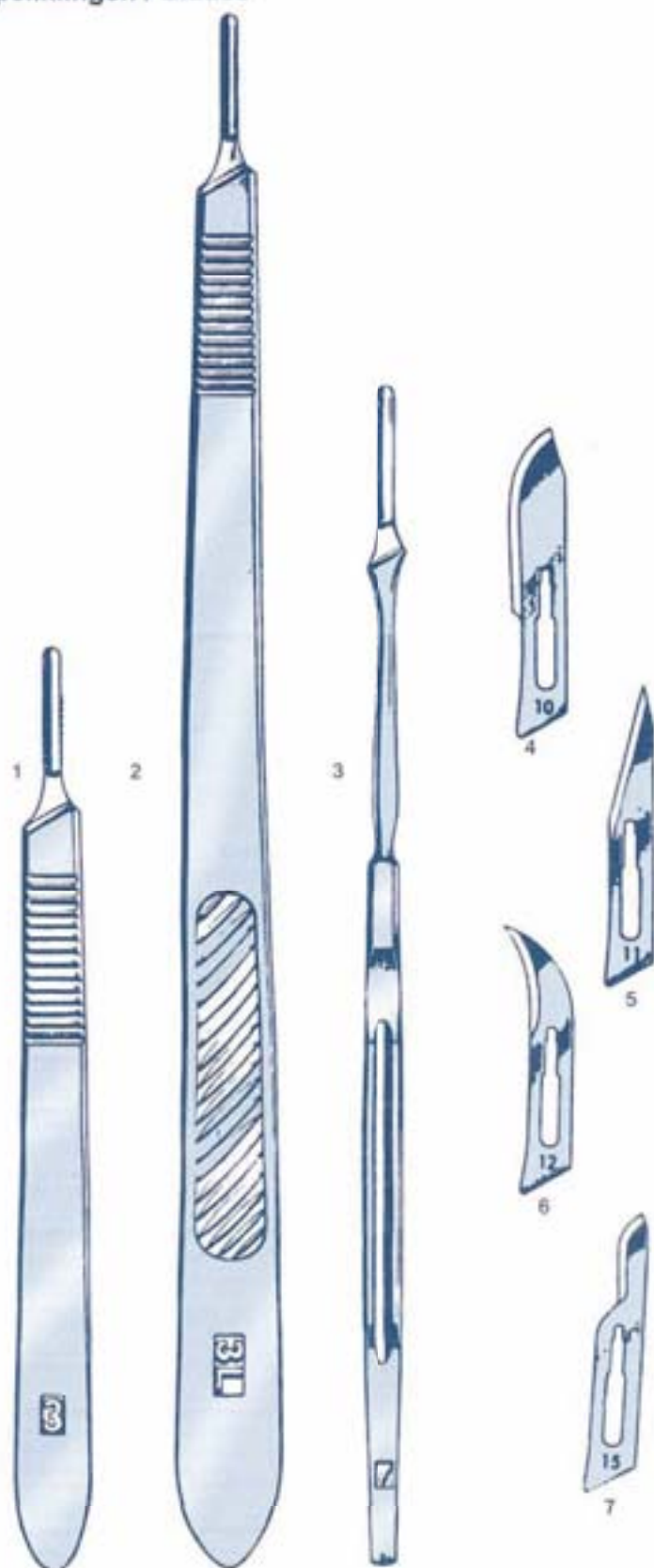

Klingenhalter Scalpel handles

1	12-0003-00
2	12-0003-00L
3	12-0007-00

S-M Einweg-Skalpellklingen S-M Single use scalpel blades

4	12-0010-00
5	12-0011-00
6	12-0012-00
7	12-0015-00

Einweg-Skalpelle auf Anfrage Single use scalpels on request

Pinzetten
Dressing forceps

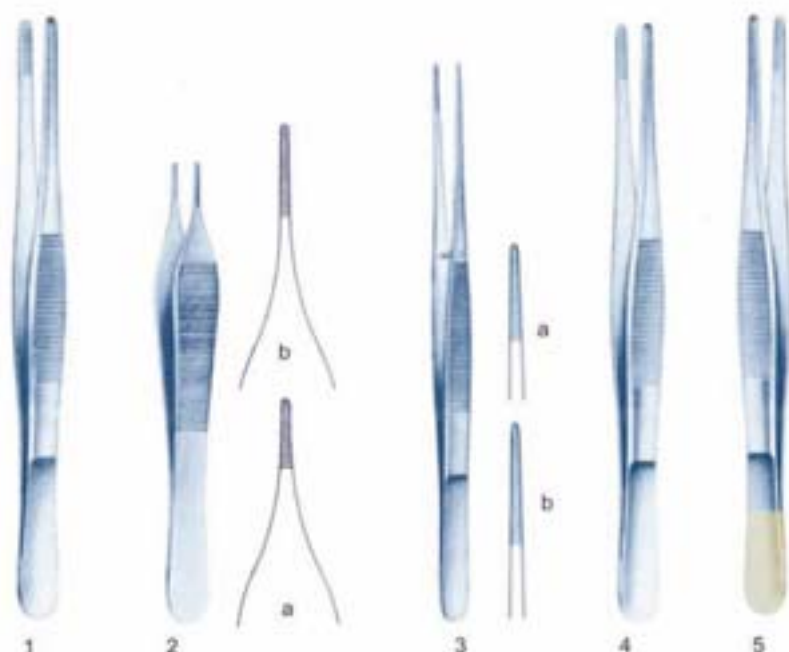

- 1 Standard - Pinzette
Standard - forceps
14,5 cm
13-0100-00
- 2 Adson - Pinzette Standard
forceps standard
1,5 mm Maulbreite / jaw
a 12 cm 13-0160-00
b 15 cm 13-0164-00
- Adson - Pinzette fein (Mikro)
forceps fine (micro)
1,0 mm Maulbreite / jaw
3 12 cm 13-0151-00
4 15 cm 13-0170-00
- 3 Wulstein - Pinzette / forceps
a 12,5 cm 14-0292-00
b 15 cm 13-0294-00



- 4 Pinzette / forceps
14,5 cm
mittel 13-0300-00
fein 13-0360-00
- 5 Wulstein - Pinzette Widiabacken
forceps, carbide inserts
1,8 mm
14,5 cm 13-9724-00
- 6 Lucae - Pinzette / forceps
14,0 cm 13-9620-00
- 7 Trölsch - Pinzette / forceps
11 cm 13-9650-00
13 cm 13-9652-00
- 8 Mikrofein - Pinzette / forceps
0,4 mm
11 cm 13-9804-00
- 9 Adson - Pinzette Widi
forceps, carbide inserts
1,7 mm
12 cm 13-9760-00

Scheren Scissors



1



2



3



4

- | | | |
|---|-------------------------|------------|
| 1 | gerade / straight | |
| | 11,5 cm | 15-0110-00 |
| | 10,5 cm | 15-0127-00 |
| 2 | gebogen / curved | |
| | 11,5 cm | 15-0111-00 |
| | 10,5 cm | 15-0128-00 |
| 3 | 11,5 cm | 15-0117-00 |
| 4 | Spencer - Fadenschere | |
| | Spencer string scissors | |
| | 9 cm | 15-0280-00 |

Scheren
Scissors



- | | |
|-----|--|
| 1 | Schere extrafein, gerade
Scissors, extrafine, straight
9,0 cm 15-0080-00 |
| 1.1 | Schere extrafein, gebogen
Scissors, extrafine, curved
9,0 cm 15-0081-00 |
| 2 | Drahtschere nach Schuknecht
Schuknecht scissors
10 cm 15-0561-00 |
| 3 | Shea - Schere
Shea scissors
12 cm 15-0299-00 |
| | Kilner - Schere
Kilner scissors
14 cm 15-0300-00 |
| 4 | Joseph - Schere, gerade
Joseph scissors, straight
14 cm 15-0150-00 |
| 5 | Joseph - Schere, gebogen
Joseph scissors, curved
14 cm 15-0151-00 |



Wundspreizer Retractors



1 Willinger Wundspreizer,
scharf
Willinger retractor
sharp
13 cm 24-0621-00

2 Wullstein Wundspreizer,
halbscharf
Wullstein retractor
semi sharp
11,0 cm 26-1941-00
13,0 cm 26-1961-00

3 Plester Wundspreizer,
halbscharf
Plester retractor
semi sharp
11,0 cm 26-2901-00
13,0 cm 26-2921-00
3.1 10,0 cm 26-2981-00
12,5 cm 26-3001-00
3.2 10,0 cm 26-2941-00
12,5 cm 26-2961-00



4 Weitlaner Wundspreizer,
Weitlaner retractor
scharf / sharp 10,5 cm 26-1170-00
scharf / sharp 13,5 cm 26-1172-00
scharf / sharp 16,5 cm 26-1174-00
halbscharf / semi sharp 10,5 cm 26-1171-04
halbscharf / semi sharp 13,5 cm 26-1172-04
halbscharf / semi sharp 16,5 cm 26-1174-04
stumpf / blunt 10,5 cm 26-1171-00
stumpf / blunt 13,5 cm 26-1173-00
stumpf / blunt 16,5 cm 26-1175-00

5 Wundspreizer,
halbscharf
Fisch retractor
semi sharp 18,0 cm 26-1881-00

Wundspreizer
Retractors



1

- 1 **Wiegand Wundspreizer**
Wiegand retractor
11 cm

3 Zähne links
3 prongs left
26-3101-00

3 Zähne rechts
3 prongs right
26-3111-00



2

- 2 **Bellucci Wundspreizer**
Bellucci retractor
13 cm

langes stumpfes Blatt links
blade blunt left
26-3141-00

langes stumpfes Blatt rechts
blade blunt right
26-3151-00

- 3 **Gelfoam Quetschzange**
Gelfoam crush forceps
nach House 16 cm
26-0800-00



3

Spreizer, Sperrer Retractors



Duraspreizer
Dura retractor
komplett mit drei Spateln
complete with 3 blades
26-6001-00



Glomus Sperrer
Glomus retractor
210 x 160 mm
26-6010-00

Tracheal - Häkchen
Tracheal retractor



Tracheal - Häkchen
tracheal retractor
17 cm

- scharf / sharp
- | | |
|---------|------------|
| 1 Haken | 24-0031-00 |
| 2 Haken | 24-0032-00 |
| 3 Haken | 24-0033-00 |
| 4 Haken | 24-0034-00 |



- stumpf / blunt
- | | |
|---------|------------|
| 1 Haken | 24-0021-00 |
| 2 Haken | 24-0022-00 |
| 3 Haken | 24-0023-00 |
| 4 Haken | 24-0024-00 |



- halbscharf / semi sharp
- | | |
|---------|------------|
| 1 Haken | 24-0001-00 |
| 2 Haken | 24-0002-00 |
| 3 Haken | 24-0003-00 |
| 4 Haken | 24-0004-00 |

Gefäßklemmen Vessel clamp

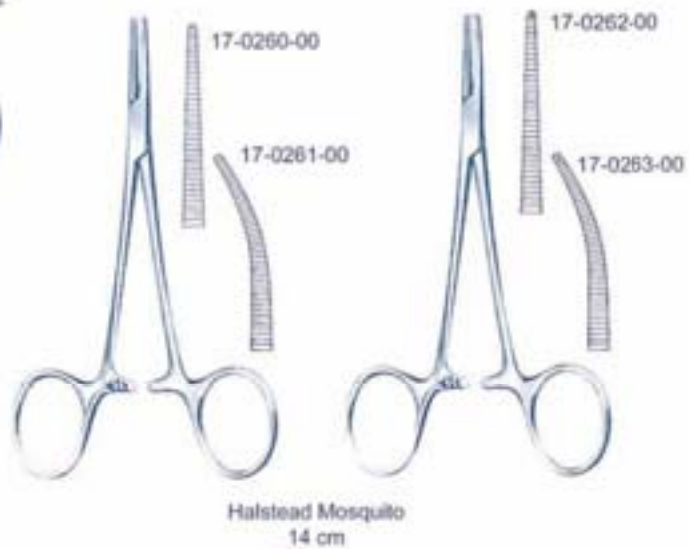
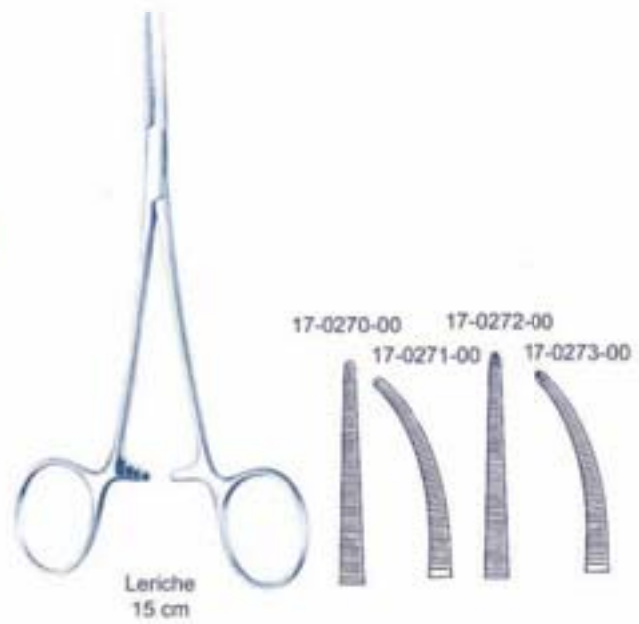
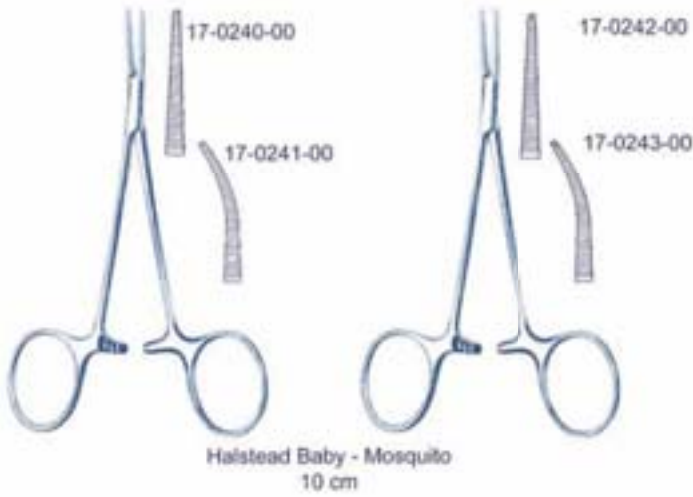

Nadelhalter mit Hartmetalleinlage
Needleholders with carbide inserts

Profile



mikrofein
delicate



feine
fine



normale
regular



glatt, ohne
smooth

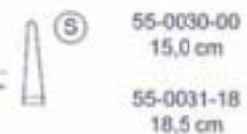
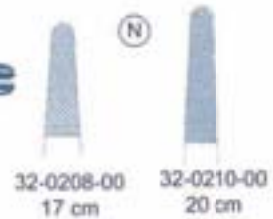
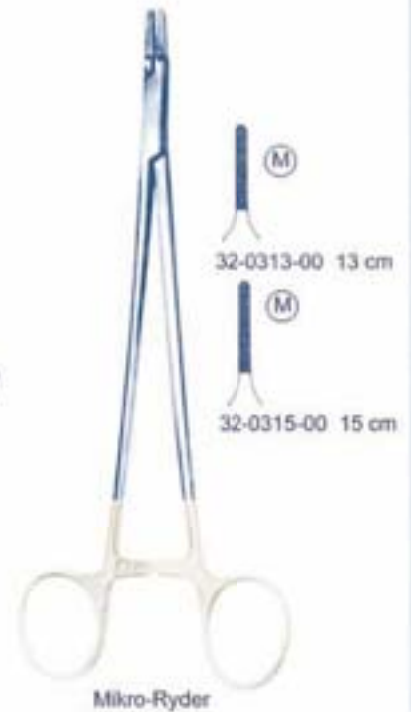

Hämmer / Mallets
Meißel / Osteotomes
Hohlmeißel / Gouge
Flachmeißel / Chisel



Hammer / mallet
 Hajek 210 mm, 200 g
 37-0011-00



Hammer / mallet
 Kunststoffbacken
 plastic disks
 190 mm, 140 g
 37-0006-00



Blutstill - Meißel
 haemostatic chisel
 120 mm
 2 mm: 37-0062-00
 3 mm: 37-0064-00



Hohlmeißel Partsch
 gouge
 140 mm
 2 mm 37-0393-02
 3 mm 37-0393-03
 5 mm 37-0393-05
 7 mm 37-0393-07
 8 mm 37-0393-08



Flachmeißel Partsch
 chisel
 140 mm
 2 mm 37-0392-02
 3 mm 37-0392-03
 5 mm 37-0392-05
 7 mm 37-0392-07
 8 mm 37-0392-08



Hohlmeißel Brünings
 gouge
 150 mm
 4 mm 37-0034-00
 6 mm 37-0036-00
 8 mm 37-0038-00
 10 mm 37-0040-00

Flachmeißel Brünings
 chisel
 150 mm
 4 mm 37-0054-00
 6 mm 37-0056-00
 8 mm 37-0058-00
 10 mm 37-0060-00



Hohlmeißel Thiesen
 gouge
 165 mm
 2 mm 37-0072-00
 3 mm 37-0073-00
 4 mm 37-0074-00
 5 mm 37-0075-00

Flachmeißel Thiesen
 chisel
 165 mm
 2 mm 37-0082-00
 3 mm 37-0083-00
 4 mm 37-0084-00
 5 mm 37-0085-00



Flachmeißel Mini
 chisel mini
 125 mm
 2 mm 37-0182-00
 4 mm 37-0183-00
 6 mm 37-0184-00
 8 mm 37-0185-00
 10 mm 37-0186-00
 12 mm 37-0187-00
 15 mm 37-0188-00

Raspatorien
Raspatories



Plester Raspatorium
Plester raspatory
17 cm 6 mm 63-0304-00
17 cm 8 mm 63-0305-00



Raspatorium m. Ferrozellgriff
Raspatory with Ferrozell-grip
18,5 cm 3 mm 37-0790-00
18,5 cm 6 mm 37-0791-00



Jansen Raspatorium
Jansen raspatory
17,5 cm 9 mm 37-0716-00
17,5 cm 14 mm 37-0717-00



Jansen Raspatorium
Jansen raspatory
16,5 cm 15 mm 37-0718-00

Raspatorien / Raspatories Elevatorien / Elevators



Lempert Raspatorium
Lempert raspatory
20 cm 3 mm 63-0308-00



Wilinger Elevatorium
Wilinger elevator
16 cm 5,0 mm 37-0816-00
17 cm 5,5 mm 37-0817-00



Wilinger Raspatorium
Wilinger raspatory
16 cm 4,0 mm 37-0774-00
16 cm 6,5 mm 37-0776-00



Muck Periostmesser
Muck periosteal knife
130 mm 37-0700-00

Hohlmeißelzangen
Rongeurs



Lempert Hohlmeißelzange
Lempert rongeur
19 cm



Beyer Hohlmeißelzange
Beyer rongeur
18 cm
3 mm 36-0810-00
4 mm 36-0810-04



Ruskin Hohlmeißelzange
Ruskin rongeur
18 cm x 5 mm 36-0812-00



Beyer Hohlmeißelzange
Beyer rongeur
18 cm x 2 mm 36-0813-00

Knochenstanzen Bone punches

Brünings Knochenstanze
Brünings bone punch
Schaftlänge 70 mm

45-0525-00 Fig. 1, 4 mm
45-0526-00 Fig. 2, 5 mm



Citelli Knochenstanze
Citelli bone punch
Schaftlänge 65 mm

45-0480-00 Fig. 1, 1 mm
45-0481-00 Fig. 2, 2 mm
45-0482-00 Fig. 3, 3 mm

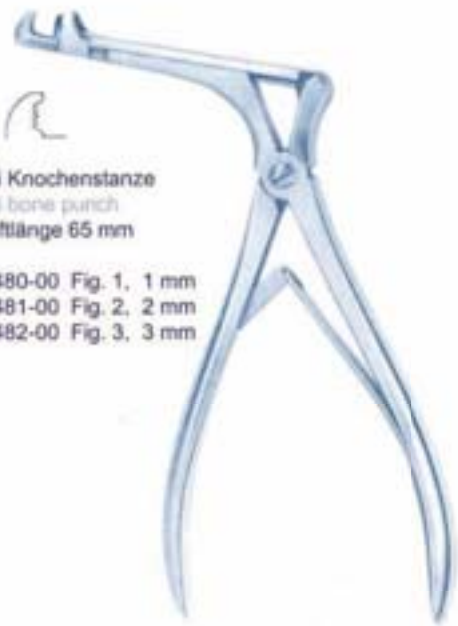

Kerrison Knochenstanze
Kerrison bone punch
Schaftlänge 90 mm

45-0520-00 Fig. 1, 3 mm
45-0521-00 Fig. 2, 4 mm
45-0522-00 Fig. 3, 5 mm



Sauger / Suction
Sauggriffe / Suction handle
Saugrohre / Suction tube

- | | | |
|---|--|--------------|
| 1 | Wulstein Sauggriff / suction handle
10 cm | 63-0360-00L |
| 2 | Sauggriff Alu, rund, leicht /
suction handle, round, light
10 cm | 63-0398-00L |
| 3 | Sauggriff, 5,5 cm
suction handle, 5,5 cm | 63-0412-00L |
| 4 | Saugrohr biegsam 16,5 cm
suction tube, pliable 16,5 cm
2,0 mm | 29-1030-00 |
| 5 | Saugrohr Standard, lang, 11 cm
suction tube standard, long, 11 cm | |
| | 1,0 mm | 63-1378-10 |
| | 1,5 mm | 63-1378-15 |
| | 2,0 mm | 63-1378-20 |
| | 2,5 mm | 63-1378-25 |
| 6 | Saugrohr Standard, kurz, 8 cm
suction tube standard, short, 8 cm | |
| | 1,0 mm | 63-1375-10 |
| | 1,5 mm | 63-1375-15 |
| | 2,0 mm | 63-1375-20 |
| | 2,5 mm | 63-1375-25 |
| 7 | Aufstecksauger, gewinkelt, 6,5 cm
attachable sucker, angled, 6,5 cm | |
| | 0,5 mm | 63-0362-00LL |
| | 0,7 mm | 63-0363-00LL |
| | 1,0 mm | 63-0364-00LL |
| | 1,3 mm | 63-0365-00LL |
| | 1,5 mm | 63-0366-00LL |
| | 1,8 mm | 63-0367-00LL |
| | 2,0 mm | 63-0368-00LL |
| | 2,5 mm | 63-0369-00LL |
| 8 | Aufstecksauger, gerade, 6 cm
attachable sucker, straight, 6 cm | |
| | 0,5 mm | 63-0413-00LL |
| | 0,7 mm | 63-0414-00LL |
| | 1,0 mm | 63-0415-00LL |
| | 1,3 mm | 63-0416-00LL |
| | 1,5 mm | 63-0417-00LL |
| | 1,8 mm | 63-0418-00LL |
| | 2,0 mm | 63-0419-00LL |

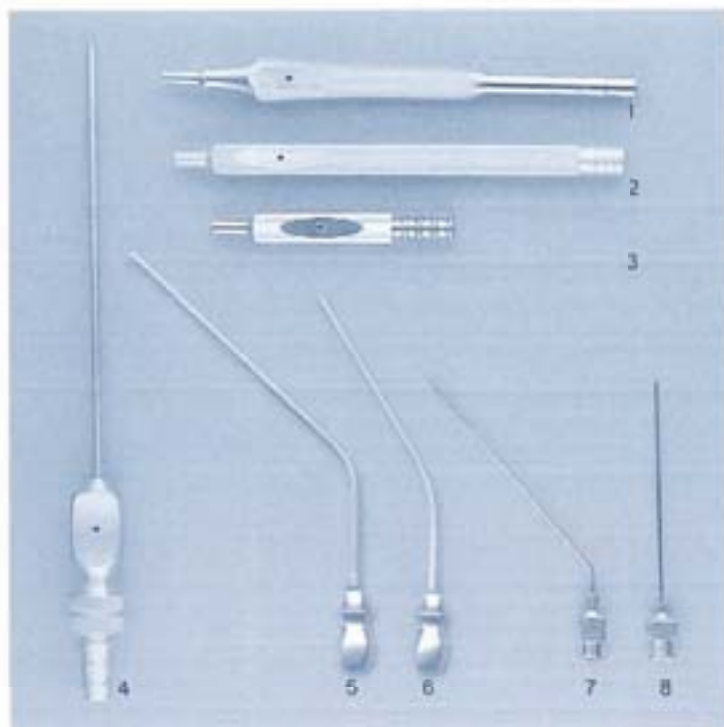

Sauger / Suction
Sauggriffe / Suction handle
Saugrohre / Suction tube

1 Saugrohr, 155 mm, biegsam mit Führunggriff zum Aufstecken von Feinsaugrohren
 suction tube, pliable with guide handle to attach fine suction tubes
 22-0260-00

2 Zöllner Sauger, 150 mm, o. Unterbr.
 sucker w/o finger cut-off
 63-0400-00
 m. Unterbr. / w. cut-off
 63-0400-02
 Zöllner Aufstecksauger
 attachable sucker
 0,4 mm 63-0430-04
 0,6 mm 63-0430-06

3 Wollstein Saugrohr / suction tube 140 mm
 o. Unterbr. / w/o cut-off
 63-0430-00
 m. Unterbr. 63-0430-01

Wollstein Aufstecksauger
 attachable sucker
 0,4 mm 63-0430-04
 0,6 mm 63-0430-06
 0,8 mm 63-0430-08

4 Silbersauger
 silver sucker
 115 mm, biegsam / pliable
 1,25 mm 63-0370-00NL
 2,00 mm 63-0371-00NL

5 Barnes Saugrohr
 suction tube
 1,5 mm 63-1377-15
 1,7 mm 63-1377-17
 2,0 mm 63-1377-20

6 Ferguson Saugrohr
 suction tube, 165 mm, Nutz-
 länge 85 mm
 Ch. 9 29-1061-00
 Ch.10 29-1062-00
 Ch.12 29-1065-00

7 Spül- & Saugrohr
 suction tube
 90 mm Nutzlänge
 Saug. Spül.
 63-0405-00 4,5 x 2,0
 63-0406-00 3,0 x 2,0
 63-0407-00 2,5 x 2,0
 63-0408-00 1,8 x 1,8

8 Baron Saugrohr
 suction tube, 13 cm
 1,0 mm 63-1376-10
 1,5 mm 63-1376-15
 1,7 mm 63-1376-17
 2,0 mm 63-1376-20

9 Plester Saugrohr
 suction tube
 1,5 mm 63-0374-00
 2,0 mm 63-0375-00
 2,5 mm 63-0376-00

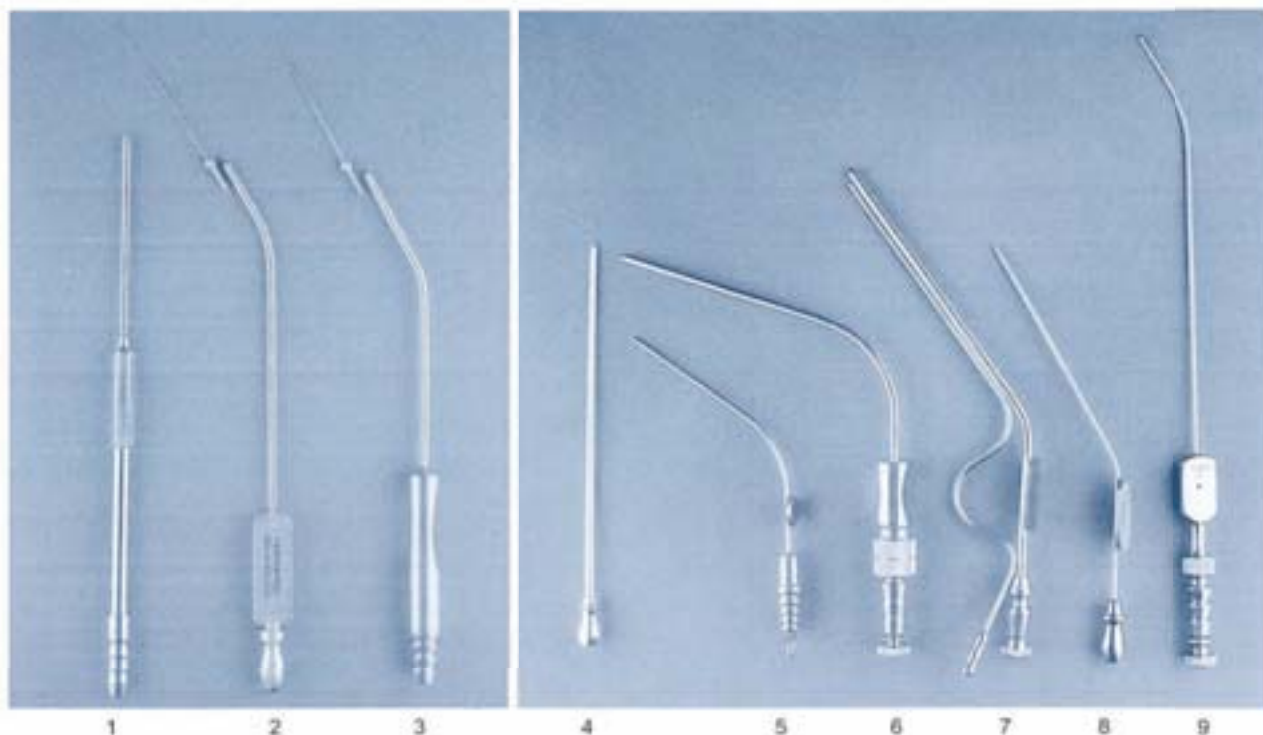

Mikro-Instrumente
Micro-instruments



Tenotom
63-0356-02



Mikro-Messer
abgewinkelt
micro knife
angled
63-0356-06



Dissektor, doppelt gebogen
dissector, double curved
rechts / right 63-0342-01
links / left 63-0342-02

Dissektor, einfach gebogen
dissector, curved
rechts / right 63-0342-03
links / left 63-0342-04



Perforatoren
perforators
0,3 mm 63-0339-03
0,4 mm 63-0339-04
0,5 mm 63-0339-05
0,6 mm 63-0339-06
0,8 mm 63-0339-08
1,0 mm 63-0339-10
1,2 mm 63-0339-12



Tiefenmessinstrument
depth measuring instrument
63-0338-00



Messzylinder
measuring cylinder
0,4 mm 63-0335-04
0,6 mm 63-0335-06
0,8 mm 63-0335-08



Tiefenmessinstrument
depth measuring instrument
Markierung bei / mark at
3,5 mm 63-0337-35
4,0 mm 63-0337-40
4,5 mm 63-0337-45
5,0 mm 63-0337-50



Seiffert Tubensonde, Feinsilber
eustachian probe, fine silver
0,5x180 mm
63-0382-00N

Ohrzangen / Ear forceps Ohrscheren / ear scissors Stanzen / punches

Wulstein Ohrzängchen	0,9 mm
House Ohrzängchen	0,6 mm
Wulstein ear forceps	0,9 mm
House ear forceps	0,6 mm

ovale Löffel oval spoon



gerade / straight	
0,6 mm	60-0856-00
0,9 mm	60-0860-00

aufgebogen / angled up	
0,6 mm	60-0859-00
0,9 mm	60-0862-00

links / left	
0,6 mm	60-0858-00
0,9 mm	60-0864-00

rechts / right	
0,6 mm	60-0857-00
0,9 mm	60-0865-00

mit runden Löffeln with round spoon



1,0 mm D	60-0868-10
1,5 mm D	60-0868-15
2,0 mm D	60-0868-20
2,5 mm D	60-0868-25

Strümpel Ohrzängchen ear forceps standard



3,0 mm	60-0870-00
fein / fine	
2,5 mm	60-0870-01

Dieter Hammerkopfstanze malleus punch



aufwärts / upward	60-0872-00
aufwärts, fein upward fine	60-0872-01



abwärts / downward	60-0872-05
--------------------	------------

Ohrzängchen auch in rechts, links und
aufgebogen lieferbar.
ear - forceps are available curved right,
curved left and curved up.

Wulstein Ohrzängchen Wulstein ear forceps



4,0 mm L	0,9 mm D	62-0100-00	3
(Superdelikat / super delicate)			
4,5 mm L	0,9 mm D	62-0150-00	
6,0 mm L	1,0 mm D	62-0140-00	
7,0 mm L	1,4 mm D	60-0850-00	
8,0 mm L	1,6 mm D	60-0852-00	



Ohrzange
Praxismodell
Ear forceps

Belucci Ohrscheren	4,5 mm
Belucci ear scissors	4,5 mm

House Ohrscheren	zart
House ear scissors	fine



gerade / straight	
Belucci	60-0881-00
House	60-0890-00

aufgebogen / angled up	
Belucci	60-0883-00
House	60-0891-00

links / left	
Belucci	60-0887-00
House	60-0892-00

rechts / right	
Belucci	60-0888-00
House	60-0893-00

Instrumente mit Zielgriff haben
die Zusatzbezeichnung „Z“
instruments with precision
handle have the additional „Z“



Neurektomieschere
neurectomy scissor
17 cm 62-0170-00

Instrumente mit Achtkant-Griff
Instruments with 8-side-grip

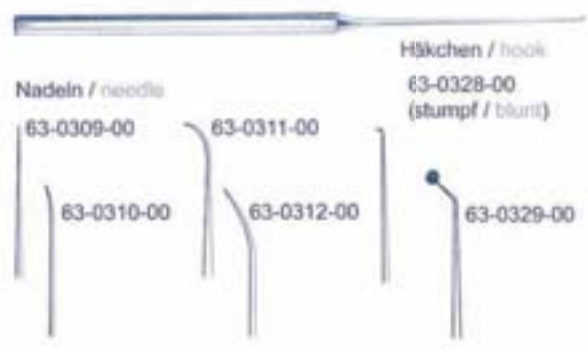

Nadeln / needle

63-0309-00

63-0311-00

63-0310-00

63-0312-00

63-0329-00

Häkchen / hook

63-0328-00
(stumpf / blunt)

Häkchen

hook 90°

- 0,3 mm 63-0313-03
- 0,4 mm 63-0313-04
- 0,5 mm 63-0313-05
- 0,6 mm 63-0313-06
- 0,8 mm 63-0313-08
- 1,0 mm 63-0313-10
- 1,2 mm 63-0313-12
- 1,5 mm 63-0313-15
- 2,5 mm 63-0313-25
- 3,0 mm 63-0313-30
- 4,0 mm 63-0313-40
- 5,0 mm 63-0313-50

Häkchen

hook 45°

- 0,3 mm 63-0321-03
- 0,4 mm 63-0321-04
- 0,5 mm 63-0321-05
- 0,6 mm 63-0321-06
- 0,8 mm 63-0321-08
- 1,0 mm 63-0321-10
- 1,2 mm 63-0321-12
- 1,5 mm 63-0321-15
- 2,5 mm 63-0321-25
- 3,0 mm 63-0321-30
- 4,0 mm 63-0321-40
- 5,0 mm 63-0321-50



Fußplattenhäkchen

footplate hook
63-0327-02
63-0327-04

2 mm

Plester

63-0323-00

Plester

Führungsgabel
guiding fork
63-0326-00



0,6 mm

Heermann
retrograde
63-0334-08



Rosen
Raspatorium
raspatory
63-0324-00



Nadeln / needle
Häkchen / hook
Doppellöffel / double
ended spoon



Kölner Modell

Cologne model
klein / small
63-0147-00
groß / large
63-0148-00

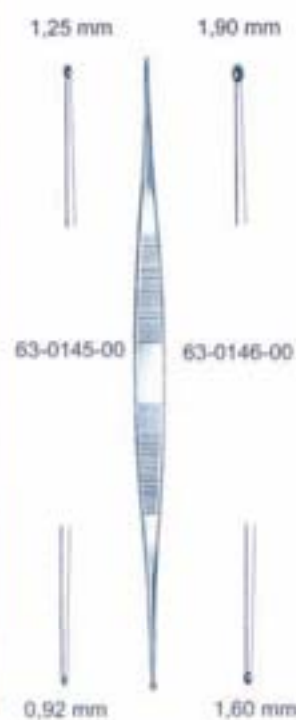

1,25 mm

1,90 mm

63-0145-00

63-0146-00

House Löffel / spoon
155 mm

0,92 mm

1,60 mm

Rundschnittmesser / Round cutting knife
Sichelmesser / Sickle knife
Fußplattenmesser / Foot plate knife
Tellermesser / Disk knife



Plester Rundschnittmesser
 Plester round cutting knife

3,5 x 2,5 mm	53-0340-00	63-0340-00 HM
4,0 x 2,0 mm	53-0340-01	
4,5 x 2,5 mm	53-0341-00	



63-03xx-xx

Kley Fußplattenmesser
 doppelschneidig
 Kley foot plate knife
 double edged
 63-0357-00



63-03xx-xx HM

Tellermesser 45°
 disk knife 45°

1,0 mm	63-0346-10
1,5 mm	63-0346-15
2,0 mm	63-0346-20
2,3 mm	63-0346-23
2,5 mm	63-0346-25
2,8 mm	63-0346-28

Tellermesser gerade
 disk knife, straight

1,0 mm	63-0352-10
1,5 mm	63-0352-15
2,0 mm	63-0352-20
2,3 mm	63-0352-23
2,5 mm	63-0352-25
2,8 mm	63-0352-28

Tellermesser 90°
 disk knife, 90°

1,0 mm	63-0342-10
1,5 mm	63-0342-15
2,0 mm	63-0342-20
2,3 mm	63-0342-23
2,5 mm	63-0342-25
2,8 mm	63-0342-28

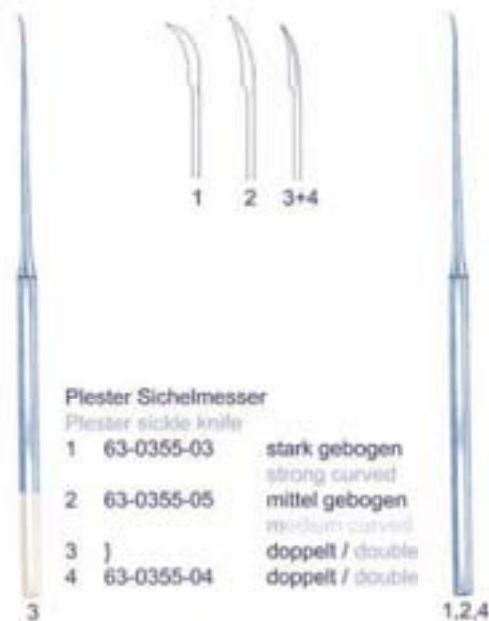

Plester Sichelmesser
 Plester sickle knife

1	63-0355-03	stark gebogen strong curved
2	63-0355-05	mittel gebogen medium curved
3	}	doppelt / double
4		63-0355-04

Buckingham Paukenspiegel
 Buckingham grommet mirror
 63-0339-30

o. Abb.: Abziehstein Arkansas
 wie foto: sharpener Arkansas
 100 x 6 mm 63-0900-06
 125 x 12 mm 63-0900-25

Otologie

Schutzhülse, Teflon,
autoklavierbar
protective shield, teflon,
autoclavable
115 mm
60-1001-00



Einsetz - Instrument für
T-Paukeröhrchen
inserter for T-ventilation
tube
6, 9, + 12 mm
60-0905-00



Mikroscherchen
zur Crurotomie
micro-ear scissor for crura

rechts schneidend / right cutting
60-0930-00

links schneidend / left cutting
60-0925-00



OP-Ständer für Mikro-Ohrzangchen
aus Edelstahl mit Schieber gegen
Herausfallen, sterilisierbar.
Für 6 Zangchen.

surgery-rack for micro-ear forceps,
stainless, with locking bolt, sterilizable, for 6
forceps
60-1000-00



Universal-Einführungszange
für Paukenröhrchen
insert forcep for ventilation tube
60-0901-00



Einführungszange für
Paukenröhrchen
insert forcep for ventilation tube
60-0906-00



Einführungsinstrument
für Paukenröhrchen
insert forcep for ventilation
tube
0,8 mm 60-0902-08
1,0 mm 60-0903-00
1,5 mm 60-0903-15

Wiegand
Saug- und Spülgriff
handle for irrigating and
suction
16 cm 63-0425-00



	standard Schaft 1,5 mm	fein / fine Schaft 0,9 mm
gerade straight	60-0950-00	60-0894-00
aufgebogen angled up	60-0951-00	60-0895-00
links left	60-0952-00	60-0896-00
rechts right	60-0953-00	60-0897-00

Mikro-Ohrscherchen
micro-ear scissor



Standard
60-0950-00
Fein / fine
60-0894-00

Schneidblock aus Pom
autoklavierbar
cutting block
90 mm x 45 mm x 10 mm
63-0338-12

Schneideblock, Kunststoff
cutting block, plastic
200x100 mm
63-0338-14



Frenzel Ohrsonde / ear probe
silber / silver 60-0208-00N



Stache Ohrsonde / ear probe
silber / silver 60-0206-00N



Hartmann Paukenspülröhrchen
irrigating cannula
gerade / straight 60-0209-00



Hartmann Paukenspülröhrchen
irrigating cannula
gebogen / curved 60-0209-04



60-0938-00



60-0940-00

Wulstein Ohrzängchen
ear forceps
Rohrschaft / tubular shaft
0,9 mm
60-0938-00
60-0940-00



Löffel nach Prof. Berger
bone curette
groß / large 63-0150-01
klein / small 63-0150-02



Heermann Meißel extra fein
gouge extra-fine



Lockerungsinstrument / laxing instrument



Heermann Meißelgriff
gouge handle
63-0720-00



McGee
Drahtschließzangchen
wire crimper
60-0877-00Z

rechts / right
60-0877-05Z

links / left
60-0877-06Z

stark abwärts / strongly downward
60-0877-08Z

modifiziert mit Zielgriff
modified with precision handle
60-0878-02Z



Grevin
Drahtschließzangchen
wire crimper
60-0877-02

Drahtschließzangchen
wire crimper
60-0878-00

Schuknecht Turm z.
Biegen von Drahtlösen
Schuknecht wire bending
63-0700-00



Heermann Hammer
mallet
63-0725-00



Bohrersysteme für die Mikrochirurgie Drilling systems for microsurgery

Besonderheiten:

Möglichkeiten zum alternierenden Einsatz zweier Motoren in je einem der vier wählbaren Geschwindigkeitsbereiche.

Hochsensible Drehzahlsteuerung.

Einfachste Änderungsmöglichkeit der Laufrichtung.

Perfekte Stabilität der Fußsteuerung. Vereinfachte Reinigung und Desinfektion der hochwertigen Systemkomponenten.

Steuerung, Motor, und Kabel der Einheit ORL-E-92 garantieren die in den Medizinernormen IEC 601-1 festgeschriebenen Sicherheiten bezüglich Elektromagnetismus.

Motor, Kabel und entsprechende Elemente sind voll sterilisierbar.

Schweizer Präzision.

Specialities:

Possibilities for the alternating usage of two engines in one each of the four selectable speed areas.

Highly-sensitive number of revolutions control.

Perfect stability of foot control.

Simplified cleaning and disinfection of the high-grade system components.

Control, engine and cable of the unity ORL E-92 guarantee the safeties regarding electro-magnetics that were established in the medicinnorms IEC 601-1.

Engine, cable and corresponding elements are fully sterilizable.

Swiss precision.

HEIMOMED Mikro Bohrersysteme

P950 m. 1 Motor

PP950 m. 2 Motoren

Drehrichtung / Turn direction	Uhrzeigersinn & gegen Uhrzeigersinn clockwise & counterclockwise
Drehzahl / Number of revs	500 - 40.000 1/min
Netzspannung / Mains voltage	230 V mit Trafo / w. transformer
Abmessungen / Dimensions	B x T x H 370 x 268 x 115 mm
Gewicht / Weight	110 g, ohne Kabel / without cable
Spülung / Irrigation	Option, extern / option, external
Bauart / Make	IEC 601-1 CE 0120
NNH Shaver	in Vorbereitung / in preparation
Handstücke / Handpieces	gerade / straight 1:1 gebogen / curved 1:1 gebogen / curved 10:1 Säge sagittal / saw sagittal Osseoscalpell Säge oszillierend gerade Saw oscillating, straight Säge oszillierend 90° abgewinkelt Saw oscillating 90°, bent

Motor und Kabel und Handstücke autoklavierbar bei 2 bar, 135° C
Engine, cable and hand pieces of autoclavable at 2 bar, 135° C

Chiropro 980 m. 1 Motor / with 1 engine

Chiropro 980 m. 2 Motoren / with 2 engines

wie P950 / Pp950, jedoch zusätzlich mit integrierter Spülung
like P950 / Pp950 but additional with integrated rinse



Mikro-Motoreinheit komplett mit Transformator 230 V
Micro engine-unit complete with transformer 230 V
61-0226-00

Irrigationseinheit PP 950 ist ein ergänzendes
Gerät zum System ORL-E92 für die Mikrochirurgie
Irrigation unit PP 950 is a supplemental piece of equipment
to the system ORL E92 for microsurgery

Irrigatoreinheit zum Mikromotor
Irrigation unit for the micro engine
61-0227-00

Mikro-Motoreinheit komplett CHIROPRO 980 mit
einem Motor und einem Kabel + Irrigationseinheit
Micro engine-unit complete CHIROPRO 980 with two
engines and two cables and irrigation unit
61-0228-00

Mikro-Motoreinheit komplett CHIROPRO 980 mit
zwei Motoren und zwei Kabel + Irrigationseinheit
micro engine-unit complete CHIROPRO 980 with two
engines and two cables and irrigation unit
61-0229-00

Mikro-Motor, alleine, autoklavierbar
Micro engine only, autoclavable
61-0223-00

Kabel, alleine, autoklavierbar
Cable only, autoclavable
61-0224-00

Mikrosägen

Optimale Griffigkeit, Lautlosigkeit und hohe Schnittpräzision für effizientes und absolut sicheres Arbeiten. Diese Instrumente sind mit extradünnen Sägeblättern ausgerüstet, die den Knochenverlust minimal halten. Die Sagittal-, Osseoscalpell- und oszillierenden Sägen sind mit einem in den Griff integrierten Spülrohr versehen. Beim Stichsägen-Modell gewährleistet ein äußeres, abnehmbares Rohr die Spülung. Die in der Nähe der Säge angeordnete Austrittsöffnung für physiologische Lösung gestattet eine einwandfreie Spülung.

Säge sagittal

Saw sagittal

61-0080-00

Osseoscalpell

61-0081-00

Säge oszillierend, vorwärts schneidend

oscillating saw, forward cutting

61-0082-00

Säge oszillierend, 90° abgewinkelt

Oscillating saw, 90° angled

61-0083-00

Handstücke für Bohrsystem

Hand pieces for drilling systems

Zwei abgewinkelte Handstücke und ein gerades Handstück, beliebte Instrumente für sicheres Arbeiten. Lösen der Spannzange durch einfaches Drehen eines Ringes von Hand. Kennzeichnung des Übersetzungsverhältnisses durch einen grünen Ring (Übersetzung 10:1) oder einen blauen Ring (Übersetzung 1:1). Bohrer-Durchmesser 2,35 mm, Länge 44,5 bis 70 mm. Außengeführtes Spray.

Two hand pieces and a straight hand piece, popular instruments for safe performance. Solve the instep rings by turning a ring of hand simply loose. Sign of the reduction ratio proportion by way of one green ring (translating 10:1) or one blue ring (translating 1:1). Drill diameter 2,35 mm, length 44,5 to 70 mm. External spray-guidance.

Bohrerhandstück gerade 1:1 blau für die Mikrochirurgie

Hand pieces straight 1:1 blue for microsurgery

61-0063-00

Bohrerhandstück abgewinkelt 1:1 blau für die Mikrochirurgie

Hand pieces angled 1:1 blue for microsurgery

61-0065-00

Bohrerhandstück abgewinkelt 10:1 (Übersetzung) grün für die Mikrochirurgie

Hand pieces angled 10:1 (reduction ratio) green for microsurgery

61-0066-00

Micro saw

Optimal grip, silence and high cutting precision for efficient and absolute sure performance. These instruments are equipped with specially-thin saw blades which hold the bone loss minimal. The sagittal, osseoscalpell and oscillating saws are provided with a washing up reed that was integrated into the handle. With the compass saw model, an outer, detachable reed maintains the rinse. The withdrawal opening entered nearby of the saw for physiological solution allowed a flawless rinsing.



Abgewinkelte Handstücke und ein gerades Handstück, beliebte Instrumente für sicheres Arbeiten. Lösen der Spannzange durch einfaches Drehen eines Ringes von Hand. Kennzeichnung des Übersetzungsverhältnisses durch einen roten Ring (Übersetzung 1:2) oder einen blauen Ring (Übersetzung 1:1). Für Handstückbohrer Standard und lang.

Angled hand pieces and a straight hand piece, popular instruments for safe performance. Solve the instep rings by turning a ring of hand simply loose. Sign of the reduction ratio proportion by way of one green ring (translating 1:2) or one blue ring (translating 1:1). For hand piece drills standard and long.

Bohrerhandstück gerade 1:1 blau für die Mikrochirurgie

Hand pieces straight 1:1 blue for microsurgery

61-0060-00

Bohrerhandstück abgewinkelt 1:1 blau für die Mikrochirurgie

Hand pieces angled 1:1 blue for microsurgery

61-0064-00

Bohrerhandstück abgewinkelt 1:2 (Übersetzung) grün für die Mikrochirurgie

Hand pieces angled 1:2 (translation) green for microsurgery

61-0068-00

Otologie

Bohrer Burr

70 mm Schaftlänge /
shaft length



Größe: size	Rosenbohrer rose burr	HM Bohrer HM burr	HM(S) Bohrer HM(S) burr Dress-E	Diamant diamond
000	61-2106-00	61-2006-00		61-2206-00
00	61-2107-00	61-2007-00		61-2207-00
0	61-2108-00	61-2008-00		61-2208-00
2	61-2110-00	61-2010-00		61-2210-00
4	61-2114-00	61-2014-00	61-2014-00S	61-2214-00
6	61-2118-00	61-2018-00		61-2218-00
8	61-2123-00	61-2023-00	61-2023-00S	61-2223-00
10	61-2127-00	61-2027-00	61-2027-00S	61-2227-00
12	61-2131-00	61-2031-00	61-2031-00S	61-2231-00
14	61-2135-00	61-2035-00	61-2035-00S	61-2235-00
16	61-2140-00	61-2040-00	61-2040-00S	61-2240-00
18	61-2145-00	61-2045-00		61-2245-00
20	61-2150-00	61-2050-00	61-2050-00S	61-2250-00
22	61-2160-00	61-2060-00	61-2060-00S	61-2260-00
24	61-2170-00	61-2070-00		61-2270-00

Größe OD mm

3/0 0.6

2/0 0.7

0 0.8

2 1.0

4 1.4

6 1.8

8 2.3

10 2.7

12 3.1

14 3.5

16 4.0

18 4.5

20 5.0

22 6.0

24 7.0

95 mm Schaftlänge /
shaft length

Größe: size	Rosenbohrer rose burr	HM Bohrer HM burr	HM(S) Bohrer HM(S) burr	Diamant diamond
4	61-2114-10	61-2014-10		61-2214-10
6	61-2118-10	61-2018-10		61-2218-10
8	61-2123-10	61-2023-10		61-2223-10
10	61-2127-10	61-2027-10		61-2227-10
12	61-2131-10	61-2031-10	61-2031-10S	61-2231-10
14	61-2135-10	61-2035-10		61-2235-10
16	61-2140-10	61-2040-10	61-2040-10S	61-2240-10
18	61-2145-10	61-2045-10		61-2245-10
20	61-2150-10	61-2050-10	61-2050-10S	61-2250-10
22			61-2060-10S	
24	61-2170-10	61-2070-10		61-2270-10

125 mm Schaftlänge /
shaft length





















Größe: size	Rosenbohrer rose burr	HM Bohrer HM burr	HM(S) Bohrer HM(S) burr	Diamant diamond
4	61-2114-12	61-2014-12		61-2214-12
6	61-2118-12	61-2018-12		61-2218-12
8	61-2123-12	61-2023-12	61-2023-12 S	61-2223-12
10	61-2127-12	61-2027-12		61-2227-12
12	61-2231-12	61-2031-12	61-2031-12 S	
14	61-2135-12	61-2035-12		61-2235-12
16	61-2140-12	61-2040-12	61-2040-12 S	61-2240-12
18	61-2145-12	61-2045-12		61-2245-12
20	61-2150-12	61-2050-12	61-2050-12 S	61-2250-12
22			61-2060-12 S	
24	61-2170-12	61-2070-12	61-2070-12 S	61-2270-12

Fräser / Fraise



Größe Size	eiförmig oval	bienenförmig glatt bee shaped smooth	bienenförmig mit Querriefen bee shaped cross-fluted
16	61-2940-00	61-3240-00	61-3540-00
20	61-2950-00	61-3250-00	61-3550-00
22	61-2960-00	61-3260-00	61-3560-00
24	61-2970-00	61-3270-00	61-3570-00
26	61-2980-00	61-3280-00	61-3580-00

20	95 mm 61-3250-10
24	61-3270-10
20	125 mm 61-3250-12
24	61-3270-12

Größe	OD mm	eiförmig	bienenförmig	walzenförmig	keulenförmig
16	4,0				
20	5,0				
22	6,0				
24	7,0				
26	8,0				



Größe Size	walzenförmig mit Querriefen cylindrical cross-fluted	keulenförmig mit Querriefen cut-gel shaped cross-fluted
16	61-3840-00	61-4440-00
20	61-3850-00	61-4450-00
22	61-3860-00	61-4460-00
24	61-3870-00	61-4470-00
26	61-3880-00	61-4480-00



Lubrifiuid 500, Schmiermittel
500 ml (VE = 6 Dosen)
61-0105-21

Spraynet 500, Reinigungsspray 500 ml
Purifying spray
(VE = 6 Dosen)
(Packing unity = 6 cans)
61-0105-23



Bürste
sterilisierbar
brush, sterilizable
61-5301-00



Knochenmeisammier
mit Teflon Auffangsieb
bonesawdust collector
with teflon-bottle
8,5 cm hoch
75-0006-00



Bohrerländer mit Deckel
für Bohrer
mit glattem Schaft
rack for burs with clip,
for burs with smooth shank,
22 pieces / 34 pieces
für 22 St. 61-5322-02
für 34 St. 61-5334-02



Tellerfräser
disk bur

- 0,8 mm 61-5008-00
- 1,0 mm 61-5010-00
- 1,5 mm 61-5015-00



Imper.-Mikrobhrer
micro burr

- 0,80 mm 61-5108-00
- 1,00 mm 61-5110-00
- 1,15 mm 61-5111-00



PE-Stanze f. d. Zunge

- PE-punch for tongue
- 4 mm 61-5114-00
 - 6mm 61-5116-00



- 023
100
61-5060-00

- 040
61-5023-00
61-5100-00

- 060
61-5040-00



Kreissäge
circular saw



- 12,5 mm
61-5212-00

- 16 mm
61-5216-00

- 19 mm
61-5219-00

- 22 mm
61-5222-00

- 25 mm
61-5225-00

Saugrohr, kniegebogen
aspirating tube, bent
90 mm 63-1374-10
63-1374-15



Saugrohr, kniegebogen
aspirating tube, bent
90 mm 63-1374-20



Saugrohr, kniegebogen
aspirating tube, bent
110 mm 63-1374-30
63-1374-40
63-1374-50



Rhinologie
Rhinology



Klingenhalter / Scalpel handels
Skalpelklingen / Blades

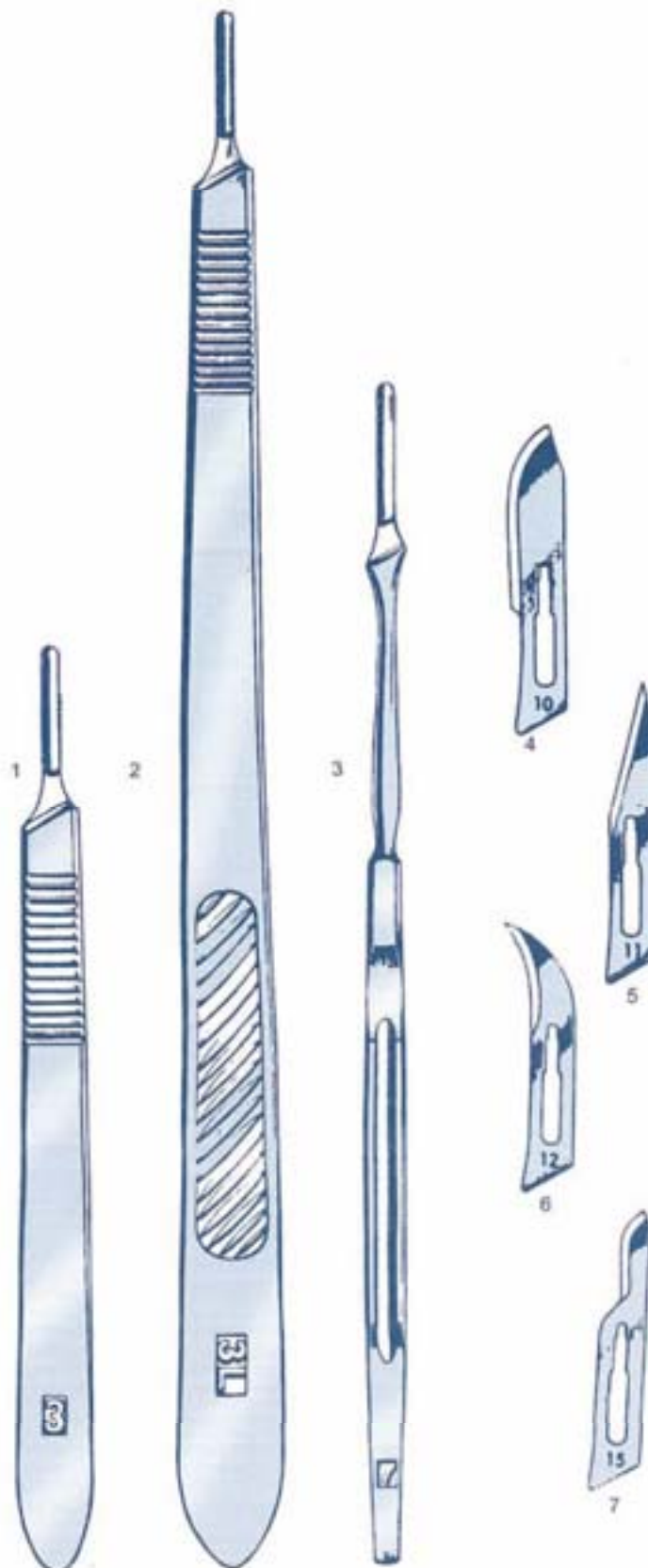

Klingenhalter
Scalpel handles

- | | |
|---|-------------|
| 1 | 12-0003-00 |
| 2 | 12-0003-00L |
| 3 | 12-0007-00 |

S-M Einweg-Skalpelklingen
S-M Single use scalpel blades

- | | |
|---|------------|
| 4 | 12-0010-00 |
| 5 | 12-0011-00 |
| 6 | 12-0012-00 |
| 7 | 12-0015-00 |

Einweg-Skalpelle
auf Anfrage
Single use scalpels
on request

Pinzetten Nasal dressing forceps

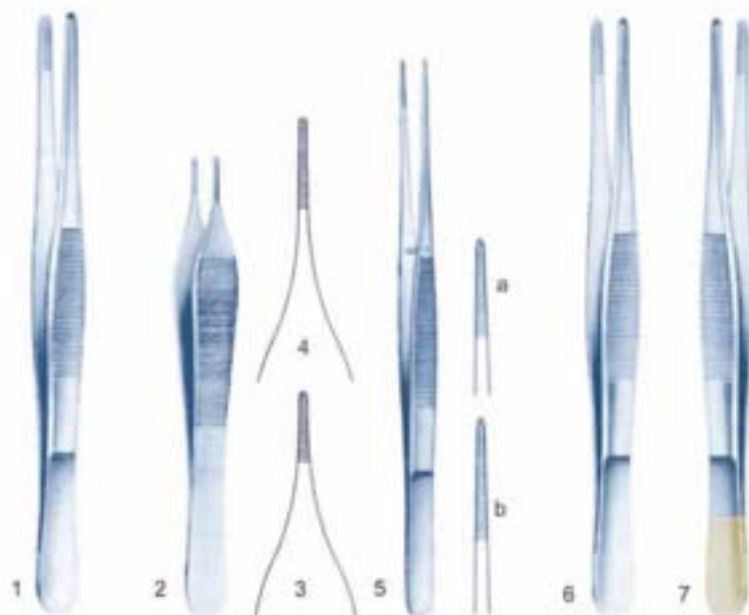



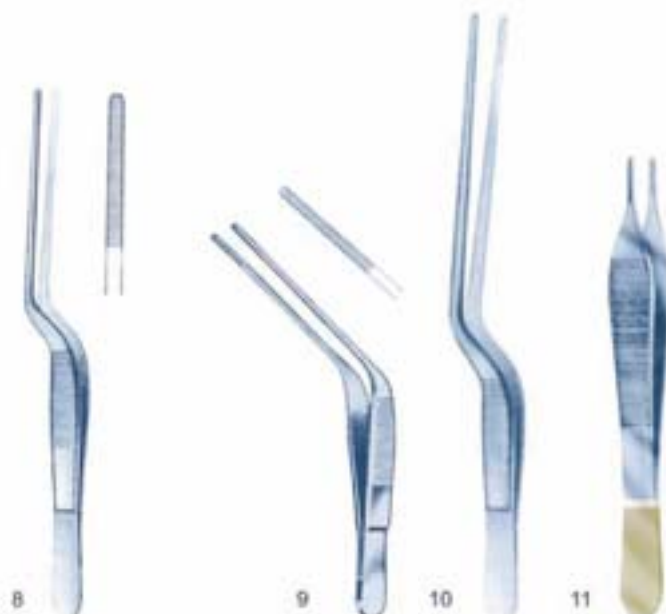









- | | | | |
|---|----------------------------------|----------------------------|------------|
| 1 | Standard | 14,5 cm | 13-0100-00 |
| 2 | Adson Standard | Adson standard | |
| 3 | 12 cm | 13-0160-00 | |
| | Adson fein (Micro) | Adson fine | |
| 4 | 12 cm | 13-0151-00 | |
| 5 | Wulstein | | |
| a | 12,5 cm | 13-0292-00 | |
| b | 15 cm | 13-0294-00 | |
| 6 | Anatomische Pinzette | Anatomical forceps 14,5 cm | |
| | mittel | 13-0300-00 | |
| | 0,8 mm | 13-0455-00 | |
| | 1,0 mm | 13-2250-00 | |
| 7 | Wulstein Widia / carbide inserts | 1,8 x 145 mm | 13-9724-00 |



- | | | | |
|----|-------------------------------|-----------------|------------|
| 8 | Lucae Bajonettpinzette | bayonet forceps | |
| | 14 cm | 13-9620-00 | |
| 9 | Trötsch | | |
| | 11 cm | 13-9650-00 | |
| | 15 cm | 13-9653-00 | |
| | 18 cm | 13-9654-00 | |
| 10 | Jansen Bajonettpinzette | bayonet forceps | |
| | 16 cm | 13-9621-00 | |
| 11 | Adson Widia / carbide inserts | 1,7 x 120 mm | 13-9760-00 |

Pinzetten
Tissue forceps

- | | | | | | |
|---|---|---|---|----|--|
| |  |  | | 1 | Chirurgische Pinzette, fein 125 mm
surgical forceps, fine
14-0292-00 |
| | | | | 2 | Chirurgische Pinzette, fein 150 mm
surgical forceps, fine
14-0294-00 |
| | | | | 3 | Anatomische Pinzette, fein 10 cm
anatomical forceps, fine
Maulbreite / jaw width 0,7 mm
13-0010-00 |
| | | | | 4 | Chirurgische Pinzette, fein 10 cm
surgical forceps, fine
Maulbreite / jaw width 0,7 mm
14-0010-00 |
|  |  |  |  | 5 | Adson Standard
12 cm 14-0160-00 |
| | | | | | Adson fein
fine (Micro)
12 cm 14-0151-00 |
| | | | | 6 | Adson-Brown
mit seitl. Zähnen 9:9
with lateral teeth 9:9
12 cm 14-0152-00 |
|  |  | | | 7 | Adson-Graefe
5:6 Zähne / teeth
12 cm 14-0295-00 |
| | | | | 8 | Chir. Pinzette / surg. forceps
7:8 Zähne / teeth
11 cm 14-0298-00 |
| | | | | 9 | Fadenpinzette 10,5 cm
thread pincers
Maulbreite / jaw width 0,6 mm
14-0970-00 |
|  |  |  |  | 10 | Chir. Pinzette / surg. forceps
gerade, zart, 2:1 Zähne
straight, fine, 2:1 teeth
10 cm
Maulbreite / jaw width 0,7 mm
14-0974-00 |
| | | | | 11 | Chir. Pinzette / surg. forceps
gebogen, zart, 2:1 Zähne
curved, fine, 2:1 teeth
10 cm
Maulbreite / jaw width 0,7 mm
14-0976-00 |

Pinzetten Nasal dressing forceps



1



2



3



4



5

- | | |
|---|---|
| 1 | Cottle
zur Insertion / for insertion
15.5 cm 13-9645-00 |
| 2 | DeBakey atraumatische Pinzette
atraumatic forceps
1,6 mm x 16 cm 13-8400-00 |
| 3 | Bayonettpinzette mit 6-7 feinen Zähnen
bayonet forceps with 6-7 fine teeth
16 cm 14-9640-00 |
| 4 | Cottle Fixierpinzette mit Schraube
fixation forceps with screw
14 cm 65-0104-00 |
| 5 | Cottle
Columellaklemme mit Schraube
columella clamp with screw
11 cm 65-0105-00 |

Scheren
Scissors



1

1.1



2



3



4



5



6

- | | |
|-----|--|
| 1 | Schere extrafein, gerade, spitz
scissors extrafine, straight, pointed
9,0 cm 15-0080-00 |
| 1.1 | Schere extrafein, gebogen, spitz-
spitz
scissors extrafine, curved, pointed-
pointed
9,0 cm 15-0081-00 |
| 2 | Fomon
12 cm 15-0324-00 |
| 3 | Shea
12 cm 15-0299-00
Kilner
14 cm 15-0300-00 |
| 4 | Joseph gerade, spitz-spitz
straight, pointed-pointed
14 cm 15-0150-00 |
| 5 | Joseph gebogen, spitz-spitz
curved, pointed-pointed
14 cm 15-0151-00 |
| 6 | Heymann
16,0 cm 15-0320-00
16,5 cm 15-0321-04
18,0 cm 15-0321-02

18,0 cm 15-0321-01
beide Schneiden gezahnt
both blades serrated |

Scheren Scissors



- | | |
|---|---|
| 1 | gerade, fein, spitz-spitz
straight, fine, pointed-pointed |
| | 11,5 cm 15-0110-00 |
| | 10,5 cm 15-0127-00 |
| 2 | gebogen, fein, spitz-spitz
curved, fine, pointed-pointed |
| | 11,5 cm 15-0111-00 |
| | 10,5 cm 15-0128-00 |
| 3 | abgewinkelt, spitz mit Knopf
angled, pointed with button |
| | 11,5 cm 15-0117-00 |
| 4 | Reynolds fein
fine |
| | 15 cm 15-0311-15 |
| | 13 cm 15-0311-13 |

Scheren Scissors



- 1 Präparierschere fein 9 cm
dissecting scissors fine
gerade / straight 15-0131-00
gebogen / curved 15-0132-00
- 2 Präparierschere fein 10,5 cm
dissecting scissors fine
gerade / straight 15-0133-00
gebogen / curved 15-0134-00
- 3 Präparierschere fein 12 cm
dissecting scissors fine
gerade / curved 15-0135-00
gebogen / curved 15-0136-00
- 4 Lexer 16,5 cm
gebogen / curved 15-0266-00

gebogen, mit Mikroschliff
curved, with micro-grind
15-0266-00 M
- 5 Schere, spitz-spitz 12,5 cm
scissor, pointed-pointed
gerade / straight 15-0142-00
gebogen / curved 15-0143-00



Scheren Scissors



1



2



2.1

1 Walter spitz, aufgewinkelt 10 cm
pointed, up-angled
15-0118-00

2 Stevens 10,5 cm
spitz, gebogen / sharp, bent
15-0165-00

2.1 Stevens 10,5 cm
stumpf, gerade / blunt, straight
15-0166-00
stumpf, gebogen / blunt, curved
15-0167-00



3



4



5

3 Metzenbaum gebogen,
stumpf-stumpf 14,5 cm
curved, blunt-blunt
15-0182-00
Microschliff
micro-ground
15-0182-00 M

4 spitz-spitz, gebogen
pointed-pointed, curved
15-0184-00

5 fein, gebogen
fine, curved
15-0193-00

Scheren
Scissors

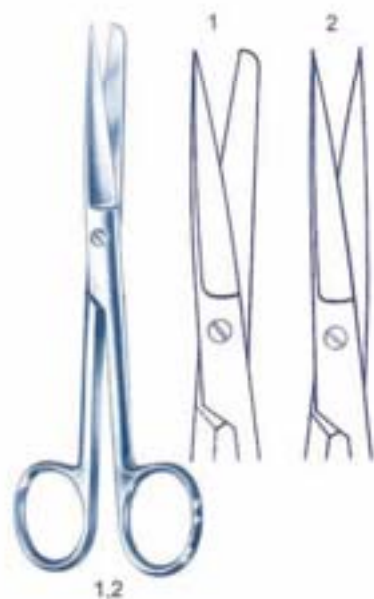

Chirurgische Scheren
Surgical scissors

- | | | |
|---|---|------------|
| 1 | 14,5 cm, gerade, spitz-stumpf
straight, pointed-blunt | 15-0614-00 |
| 2 | 14,5 cm, gerade, spitz-spitz
straight, pointed-pointed | 15-0624-00 |
| 3 | 14,5 cm, gebogen, stumpf-stumpf
curved, blunt-blunt | 15-0634-00 |
| 4 | 14,5 cm, gebogen, spitz-stumpf
curved, pointed-blunt | 15-0644-00 |
| 5 | 14,5 cm, gebogen, spitz-spitz
curved, pointed-pointed | 15-0654-00 |

Verbandschere, Mikroschliff
Bandage scissors with micro-grinding

- | | | |
|--------|---------|--------------|
| Lister | | |
| 6 | 9,0 cm | 15-0694-00 M |
| | 11,5 cm | 15-0695-00 M |
| | 14,0 cm | 15-0696-00 M |
| | 18,0 cm | 15-0697-00 M |
| | 20,0 cm | 15-0698-00 M |



Scheren Scissors



1



2

- | | | |
|---|---|------------|
| 1 | Fomon
dorsal 14,0 cm | 15-0327-00 |
| 2 | Cottle
dorsal 16 cm | 15-0328-00 |
| 3 | Cottle
stark gebogen
strong curved
11,5 cm | 15-0329-00 |



3

Septumkanülen / Septum cannulas
Septumspritze / Septum syringe

Septumkanülen
Septum cannulas

gebogen curved	gerade straight	bajonettform bayonet-shaped	kniegebogen knee-shaped
0,8 mm	0,8 mm	0,8 mm	0,8 mm
12-1170-00	12-1171-00	12-1172-00	12-1173-00



Septumspritze
Luer-Lock Ansatz
Septum syringe
Luer-lock attachment

2 ml	74-0453-00
5 ml	74-0454-00



Gefäßklemmen Haemostatic forceps



- | | | |
|---|----------------------------|------------|
| 1 | Halstead Gefäßklemme | |
| | 12,5 cm, gerade / straight | 17-0256-00 |
| | 12,5 cm, gebogen / curved | 17-0257-00 |

- | | | |
|---|----------------------------|------------|
| 2 | Halstead Gefäßklemme | |
| | 1:2 Zähne / teeth | |
| | 12,5 cm, gerade / straight | 17-0258-00 |
| | 12,5 cm, gebogen / curved | 17-0259-00 |

- | | | |
|---|-------------------------------|------------|
| 3 | Präparierklemme | |
| | ohne Sperre / without ratchet | |
| | 14 cm, gerade / straight | 17-0288-00 |
| | 14 cm, gebogen / curved | 17-0289-00 |



Gefäßklemmen
Vas clamp



- | | | |
|---|--------------------------|------------|
| 1 | Kelly | |
| | 14 cm, gerade / straight | 17-0290-00 |
| | 14 cm, gebogen / curved | 17-0291-00 |

- | | | |
|---|--------------------------|------------|
| 2 | Rochest.-Pean | |
| | 14 cm, gerade / straight | 17-0300-00 |
| | 18 cm, gerade / straight | 17-0304-00 |
| | 14 cm, gebogen / curved | 17-0301-00 |
| | 18 cm, gebogen / curved | 17-0305-00 |

- | | | |
|---|--------------------------|------------|
| 3 | Ochsn.-Kocher | |
| | 14 cm, gerade / straight | 17-0400-00 |
| | 18 cm, gerade / straight | 17-0404-00 |
| | 14 cm, gebogen / curved | 17-0401-00 |
| | 18 cm, gebogen / curved | 17-0405-00 |





Kornzangen / Sponge forceps Tuchklemmen / Towel clamp



Maier Kornzangen / sponge forceps

- | | | |
|---|-----------------------------------|------------|
| 1 | ohne Sperre / without ratchet | |
| | 20 cm, gerade / straight | 19-0518-00 |
| | 20 cm, gebogen / curved | 19-0519-00 |
| 2 | mit Sperre / with ratched | |
| | 20 cm, gerade / straight | 19-0520-00 |
| | 20 cm, gebogen / curved | 19-0521-00 |
| 3 | Backhaus Tuchklemme / towel clamp | |
| | 9 cm | 19-0109-00 |
| | 11 cm | 19-0111-00 |

Nadelhalter
Needle holder

Profil



mikrofein
delicate



feine
fine



normale
regular



glatt, ohne
smooth



Derf
13 cm

32-0100-00 (F)



Webster
13 cm

32-0102-00 (S)



Halsey
13 cm

32-0104-00 (F)

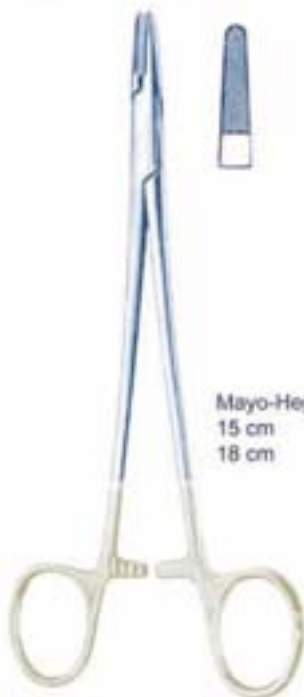

Mayo-Hegar
15 cm 32-0110-00 (F)
18 cm 32-0114-00 (N)



Crile-Wood
15 cm 32-0150-00 (F)

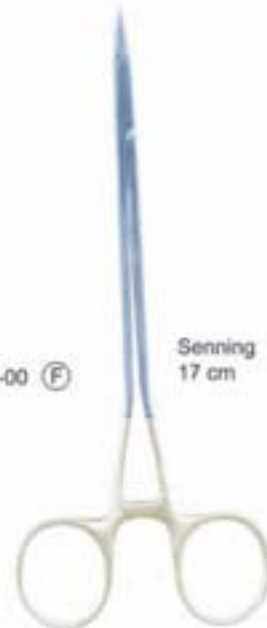

Senning
17 cm 32-0160-00 (F)

Nadelhalter Needle holder

Profilie

mikrofein
delicate



feine
fine



normale
regular



glatt, ohne
smooth



Olsen-Hegar
Nadelhalter mit Schere
needle holder with scissor
12,5 cm 32-0190-00 (M)
14,0 cm 32-0191-00 (F)



De Bakey
18 cm 32-0152-00 (F)
20 cm 32-0153-00 (F)
23 cm 32-0154-00 (F)



Lichtenberg
20 cm 32-0218-00 (F)

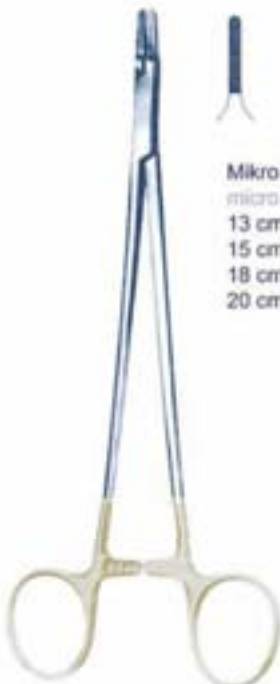

Mikro Modell
micro model
13 cm 32-0313-00 (M)
15 cm 32-0315-00 (M)
18 cm 32-0318-00 (M)
20 cm 32-0320-00 (M)



Mathieu mit Innensperre
with barrier inside
17 cm 32-0208-00 (N)
20 cm 32-0210-00 (N)

Gillies
13 cm 32-0174-00 (F)
14 cm 32-0174-02 (F) Mini



Nasentamponadenzangen
Nasal dressing forceps

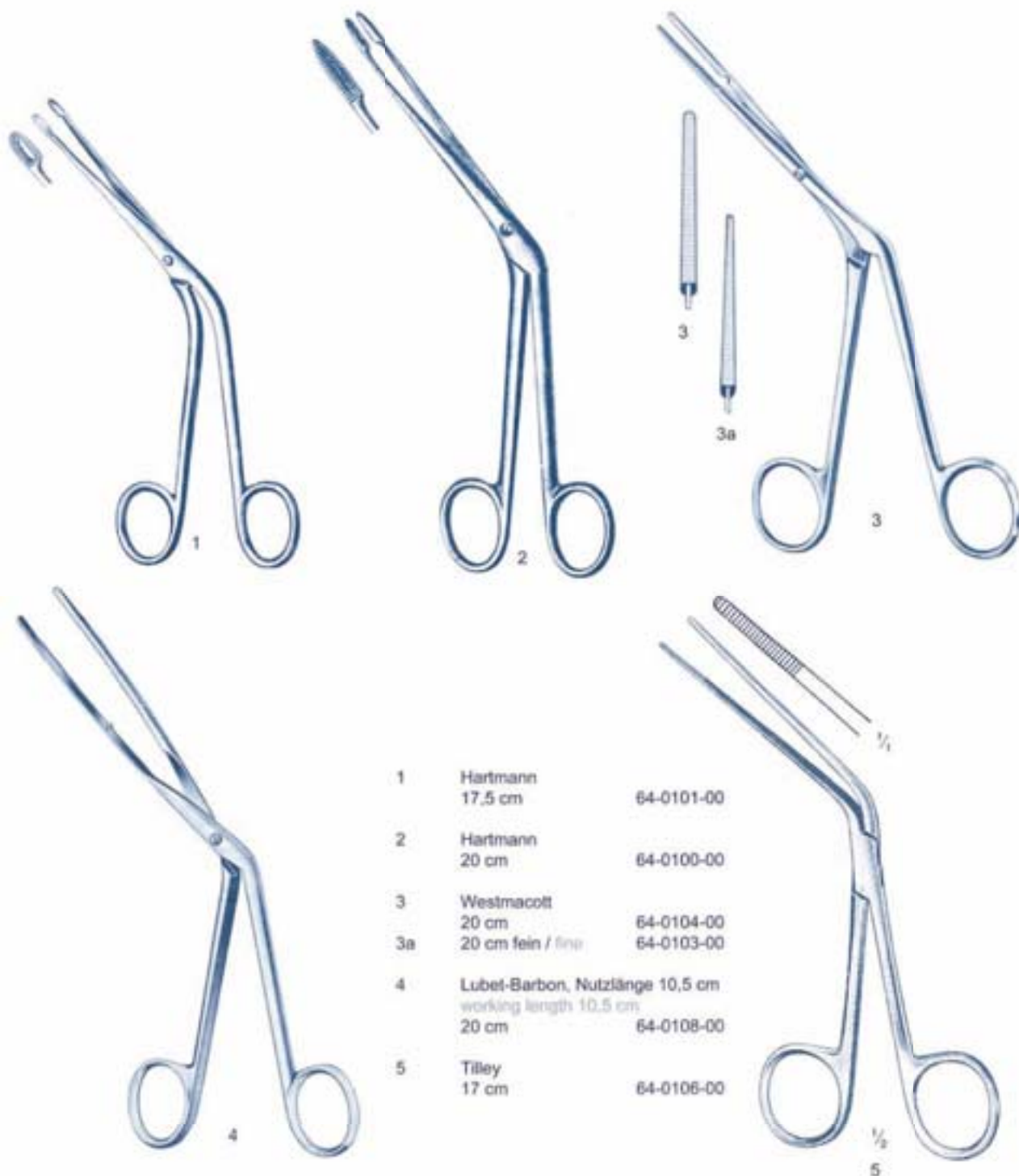

- | | | |
|----|--|------------|
| 1 | Hartmann
17,5 cm | 64-0101-00 |
| 2 | Hartmann
20 cm | 64-0100-00 |
| 3 | Westmacollt
20 cm | 64-0104-00 |
| 3a | 20 cm fein / fine | 64-0103-00 |
| 4 | Lubel-Barbon, Nutzlänge 10,5 cm
working length 10,5 cm
20 cm | 64-0108-00 |
| 5 | Tilley
17 cm | 64-0106-00 |



**Lange
Ätzmittelträger**
caustic carrier
18 cm
64-0945-00 N



**Frenzel
Ätzmittelsonde**
caustic tube
14 cm
64-0946-00



**Ziegler
Watteträger gerieft**
cotton applicator,
ribbed
18 cm
64-0942-00



**Watteträger,
doppelt gerieft**
cotton applicator,
double ribbed
9 cm
64-0937-00



**Choanenhaken / choana-hook
Fränkel**
22 cm
64-0948-00



Lange
23 cm
64-0949-00

Watteträger
Cotton applicators



doppelt gerieft
double spiral
biegsam / pliable

7,5 cm
12,0 cm
12,0 cm
14,0 cm
16,0 cm

1,2 mm 60-0224-00
1,2 mm 60-0225-02
1,2 mm 60-0225-00



dreikant gerieft
triangular

1,0 mm 60-0222-00
1,2 mm 60-0219-00
1,2 mm 60-0221-00



gerieft
rough

1,0 mm 60-0223-00
0,8 mm 60-0217-00
1,2 mm 60-0218-00
1,2 mm 60-0220-00

Nasenspekula
Nasal specula



Spezialmodelle
Special models

13 cm für Erwachsene
for adult
64-0036-00

für Säuglinge mit Einsteckschloß und Gabelfeder
for baby with ratchet lock and knuckle spring
64-0098-00

13 cm für Kinder
for child
64-0099-00



Mit leicht zerlegbarem Einhakeschloß
w. easy divisible joint

Goldsmith



Beckmann
normal / normal
Fig.1 64-0091-01
Fig.2 64-0091-02
Fig.3 64-0091-03

für Säuglinge / neonates
64-0092-00



Hartmann
leichtes Modell
light model
64-0020-00



Nasenspekula Nasal specula

Hartmann
16 cm

64-0021-00

64-0022-00

64-0023-00

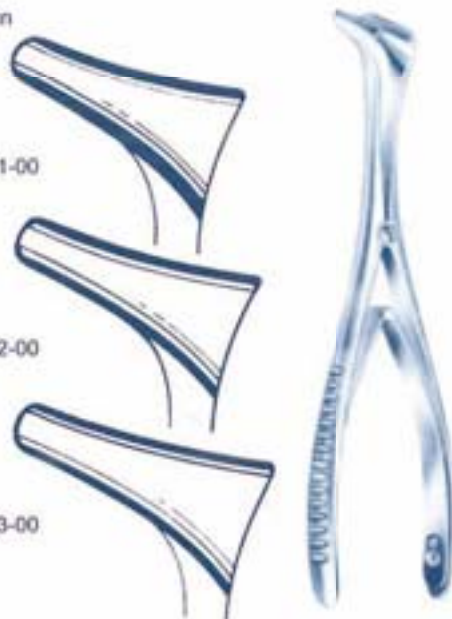

Tieck-Halle
für Kleinkinder
for infants
13 cm
64-0061-00



Tieck-Halle
extra klein für Babies
extra small for babies
64-0061-02

Hartmann-Halle

64-0027-00

64-0028-00

64-0029-00



Hartmann-Halle
schlank

64-0031-00

64-0032-00

64-0033-00

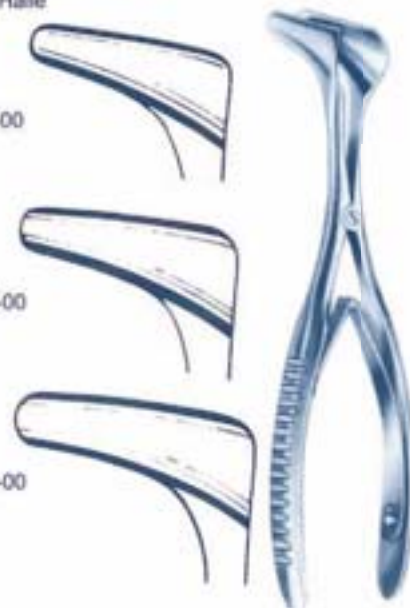

Nasenspekula
Nasal specula

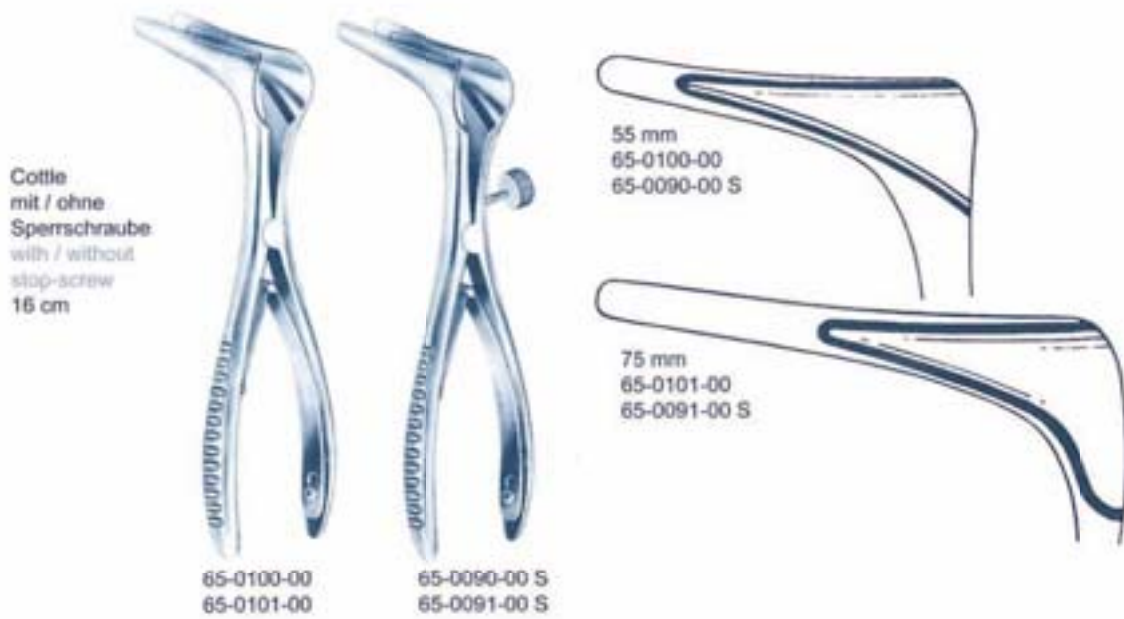
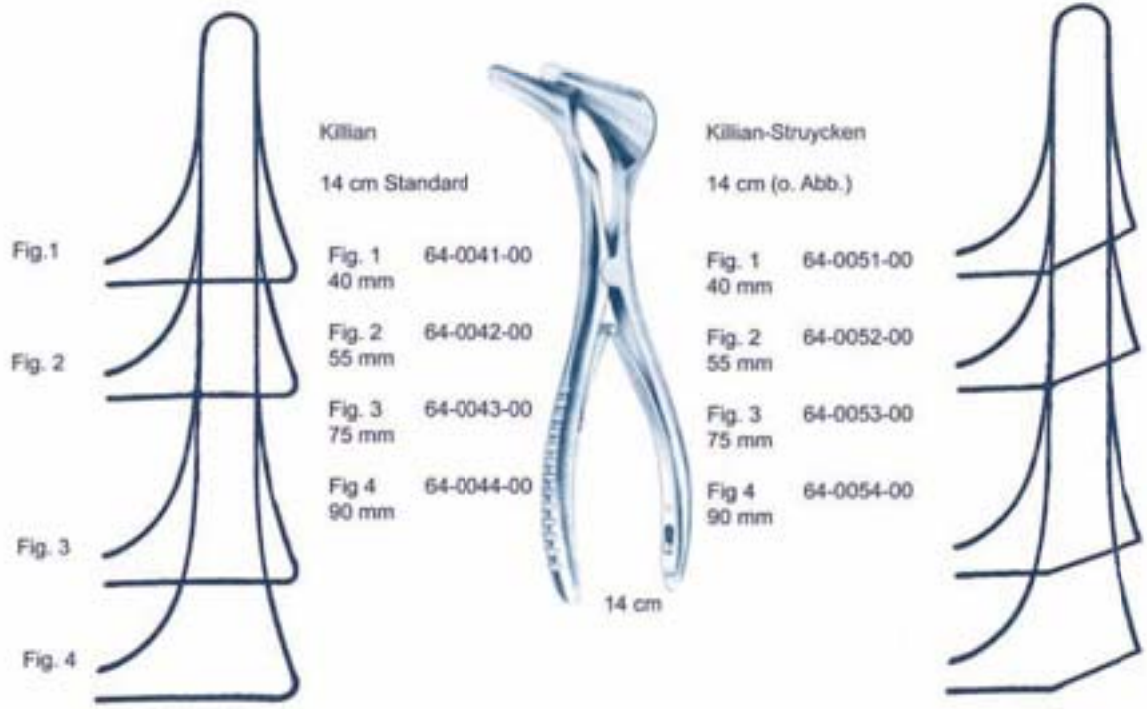

Nasenspekula Nasal specula

Nasenspekulum mit Schraube und Ansatz für Haltearm
Nasal speculum w. screw and attachment for holder

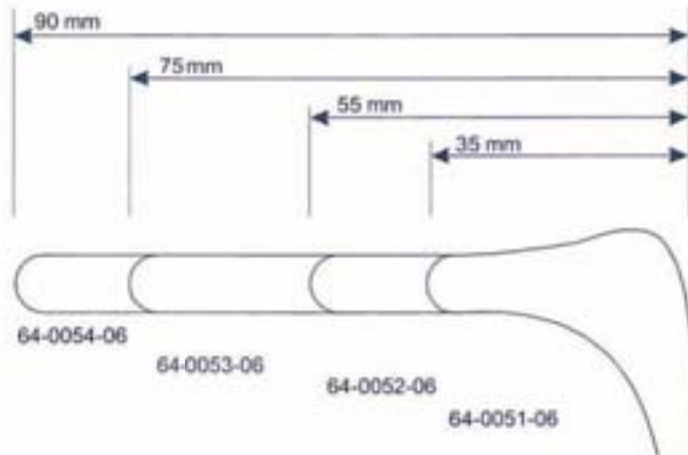

rechts kurzes Blatt
right blade shortend
links kurzes Blatt
left blade shortend

55 mm	75 mm
64-0057-02	64-0058-02
64-0057-04	64-0058-04



Walter	
14 cm	
40 mm	65-0095-01
55 mm	65-0095-02
75 mm	65-0095-03
90 mm	65-0095-04



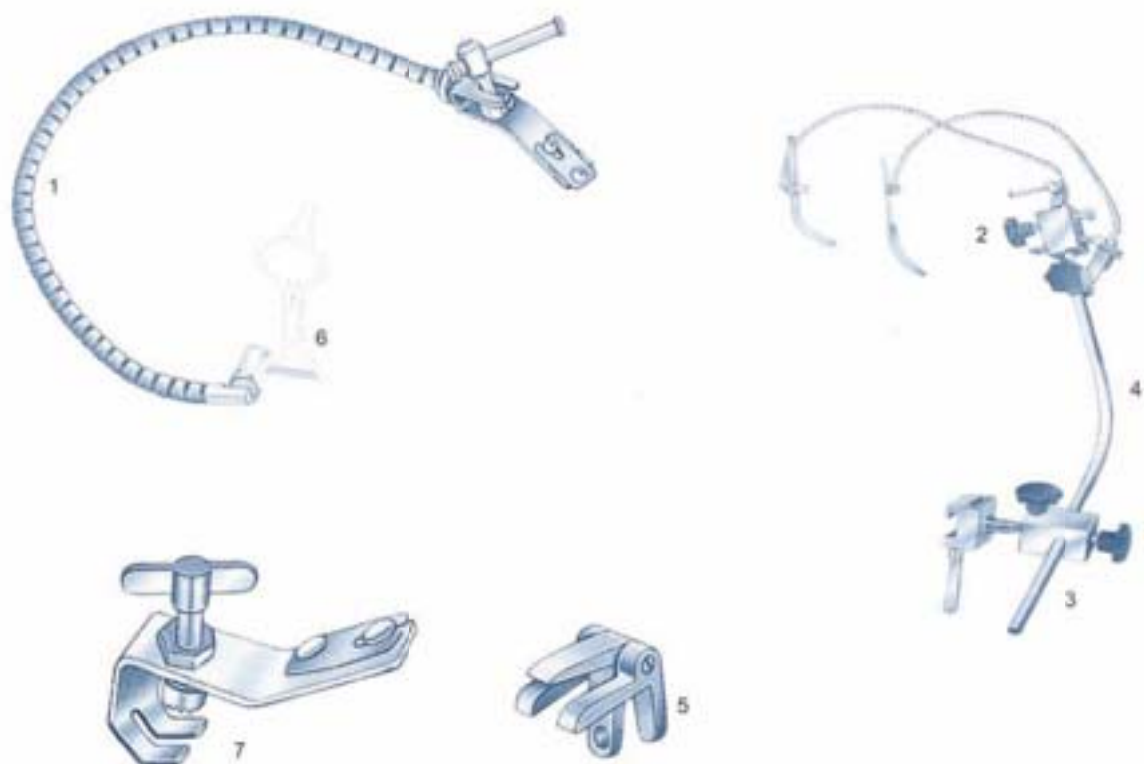

- | | | |
|---|---|------------|
| 1 | Spannarm alleine / flexible arm only | 27-0010-00 |
| 2 | Kopplungskopf drehbar / connector rotary | 27-0020-00 |
| 3 | Gelenk Kloben zur Befestigung an der OP Schiene 9 x 32 mm
Vice link for the fortification of the OP rail | 27-0010-04 |
| 4 | Haltearm / holder | 27-0010-06 |
| 5 | Halter für flache Hirnspatel / holder for flat brain blades | 27-0010-08 |
| 6 | Ohrtrichterhalter alleine / ear specula only | 27-0010-14 |
| 7 | Fixiervorrichtung für 1 Arm an Rohrteilen
bis Durchmesser 16 mm
Fixing unit for 1 arm of tube-parts up to 16 mm | 27-0010-02 |
| | o. Abb.: Verbindung vom Spannarm zur Trokarhülse
junction flexible arm to trocar tube | 27-0010-12 |
| | o. Abb.: Adapter für Heimomed - Optiken
adapter for Heimomed optics | 27-0010-10 |

Sauger Suction



Ferguson Saugrohr
suction tube
185 mm,
Nutzlänge 85 mm
working length

Ch 9 29-1061-00
Ch10 29-1062-00
Ch11 29-1063-00

Saugrohre suction tube	1 Nasensauger 14 cm nasal suction tube Nutzlänge 110 mm working length 110 mm	2 Sauger suction tube 18 cm	3 flache Spitze flat tip w. hub 17 cm, mit Bohrung with drilling	4 Frazier 13 cm	5 Präpariersauger mit Mandrin dissecting suction with mandrin 18,5 cm 29-1120-00
2,0 mm		29-0130-00		Ch 5 29-1005-00	
2,5 mm	64-0510-00			Ch 6 29-1006-00	
3,0 mm	64-0511-00	29-0131-00	29-0362-30	Ch 7 29-1007-00	
3,5 mm	64-0512-00			Ch 8 29-1008-00	
4,0 mm	64-0513-00	29-0133-00	29-0362-40	Ch 9 29-1009-00	
5,0 mm	64-0514-00		29-0362-50	Ch 10 29-1010-00	
6,0 mm	64-0515-00		29-0362-60	Ch 11 29-1011-00	
7,0 mm	64-0516-00			Ch 12 29-1012-00	





Cottle-Kazanjan
Knorpelschere 18 cm
cartilage scissor
64-0617-00



Ruskin-Rowland
Knorpelschere 18 cm
cartilage scissor
64-0618-00 gerade / straight
64-0618-04 gebogen / curved



Rubin
Quetschzange
21 cm
crushing forceps
64-0625-00



Rowland
Knorpelschere
20 cm
cartilage scissor
64-0619-00



Caplan Schere
20 cm
scissors
64-0619-04



Kressner
Muschelquetschzange
crushing forceps
2,5 mm 22 cm 64-0628-00
4 mm 23 cm 64-0629-00

Nasenzangen Nasal forceps



Middleton-Jansen
scharf / sharp
10 cm Nutzlänge
10 cm working length
64-0615-00



Middleton-Jansen
scharfe / sharp
9 cm Nutzlänge
9 cm working length
64-0616-00

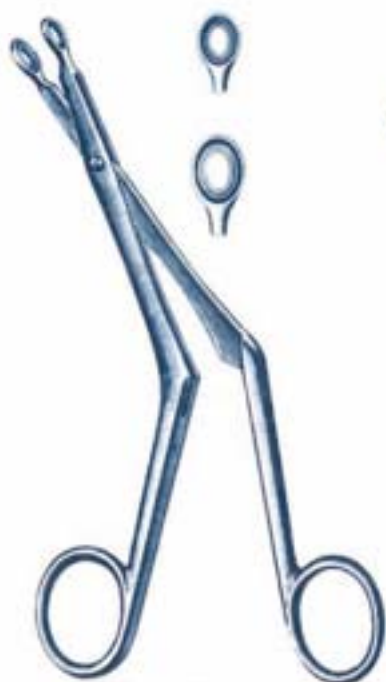

Brünings Septumzange
septal forceps
11 cm Nutzlänge
11 cm working length
Fig. 1 64-0620-00
Fig. 2 64-0621-00



Craig gerade, scharf
straight, sharp
170 mm
64-0632-00



Craig
170 mm
rechts / right 64-0633-00
links / left 64-0634-00

Nasennebenhöhle / Paranasal sinuses
Nasenzangen / Nasal forceps

Stanze, retrograd
Punch, retrograde

1



2,5 mm aufwärts / upwards 45-0523-01 U

2



2,5 mm rechts / right 45-0523-05 U

3



2,5 mm links / left 45-0523-06 U

andere Größen auf Anfrage
other sizes on request



Takahashi
scharfe Nasenzange
nasal cutting forceps,
sharp

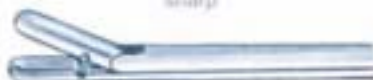

3x10 mm 64-0636-00



3x10 mm 64-0637-00

Watson-Williams
scharfe Nasenzange
nasal forceps, sharp
glatt / smooth 64-0638-00
gezahnt / serrated 64-0639-00



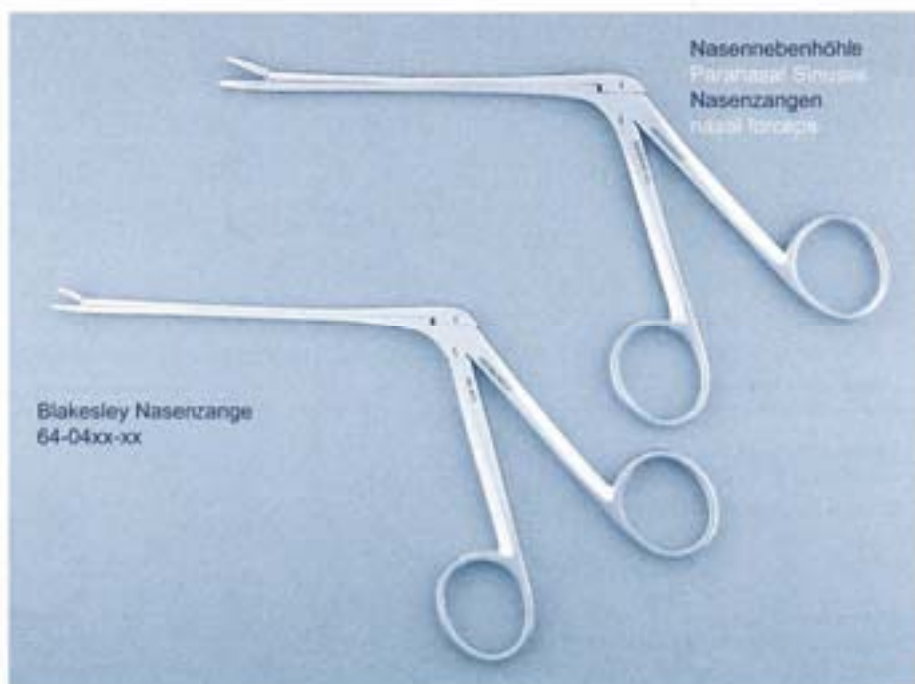

Blakesley gerade straight



	Schaft Länge shaft length	Maul Höhe jaw high	Breite width	Länge length	Art.-Nr. Cat. No.
Fig. 00000	120 mm	3,5 mm	1,7	8,0 mm	64-0398-00 H
Fig. 0000	120 mm	3,5 mm	2,0	8,0 mm	64-0399-00 H
Fig. 00	120 mm	4,0 mm	2,5	8,0 mm	64-0401-00 H
Fig. 0	120 mm	4,0 mm	3,0	10,0 mm	64-0402-00 H
Fig. 1	120 mm	4,5 mm	3,5	10,0 mm	64-0403-00 H
Fig. 2	120 mm	5,0 mm	4,0	14,0 mm	64-0404-00 H
Fig. 3	120 mm	5,0 mm	4,5	14,0 mm	64-0405-00 H
Fig. 4	120 mm	5,0 mm	6,0	15,0 mm	64-0406-00 H

Blakesley 45°



Fig. 00000	120 mm	3,5 mm	1,7	8,0 mm	64-0408-00 H
Fig. 0000	120 mm	3,5 mm	2,0	8,0 mm	64-0409-00 H
Fig. 00	120 mm	4,0 mm	2,5	8,0 mm	64-0411-00 H
Fig. 0	120 mm	4,0 mm	3,0	10,0 mm	64-0412-00 H
Fig. 1	120 mm	4,5 mm	3,5	10,0 mm	64-0413-00 H
Fig. 2	120 mm	4,5 mm	4,0	13,0 mm	64-0414-00 H
Fig. 3	120 mm	4,5 mm	4,5	14,0 mm	64-0415-00 H
Fig. 4	120 mm	5,0 mm	6,0	14,0 mm	64-0416-00 H

Blakesley 45°, mit langem Löffel / with long spoon

Fig. 2	120 mm	4,5 mm	4,0	20,0 mm	64-0414-20 H
--------	--------	--------	-----	---------	--------------



Blakesley 90°, mit stumpfen Maul / with blunt jaw

Fig. 0	120 mm	4,0 mm	3,0	10,0 mm	64-0429-00 HR
Fig. 1	120 mm	4,5 mm	3,5	10,0 mm	64-0430-00 HR
Fig. 2	120 mm	4,5 mm	4,0	13,0 mm	64-0431-00 HR
Fig. 3	120 mm	4,5 mm	4,5	14,0 mm	64-0432-00 HR



Absaugung oben
Suction on top

Blakesley gerade mit Absaugung oben / straight with suction on top

Fig. 00	120 mm x 4,0 mm,	2,5 x	8,0 mm	64-0401-00 HO
Fig. 0	120 mm x 4,0 mm,	3,0 x	10,0 mm	64-0402-00 HO
Fig. 1	120 mm x 4,5 mm,	3,5 x	10,0 mm	64-0403-00 HO



Blakesley 45° mit Absaugung oben / straight with suction on top

Fig. 00	120 mm x 4,0 mm,	2,5 x	8,0 mm	64-0411-00 HO
Fig. 0	120 mm x 4,0 mm,	3,0 x	10,0 mm	64-0412-00 HO
Fig. 1	120 mm x 4,5 mm,	3,5 x	10,0 mm	64-0413-00 HO



Absaugung unten
suction below

Blakesley gerade mit Absaugung unten / suction below

Fig. 00	120 mm x 4,0 mm,	2,5 x	8,0 mm	64-0401-00 HU
Fig. 0	120 mm x 4,0 mm,	3,0 x	10,0 mm	64-0402-00 HU
Fig. 1	120 mm x 4,5 mm,	3,5 x	10,0 mm	64-0403-00 HU



Blakesley 45° mit Absaugung unten / suction below

Fig. 00	120 mm x 4,0 mm,	2,5 x	8,0 mm	64-0411-00 HU
Fig. 0	120 mm x 4,0 mm,	3,0 x	10,0 mm	64-0412-00 HU
Fig. 1	120 mm x 4,5 mm,	3,5 x	10,0 mm	64-0413-00 HU



durchschneidend / cutting through
rundes Maul / round jaw
m. Absaugung oben / w. suction on top
m. Absaugung unten / w. suction below
m. durchschneidend m. Absaugung oben / cutting through with suction on top
m. durchschneidend m. Absaugung unten / cutting through with suction below

D
R
O
U
D
U

Nasenzangen
Nasal forceps



Grünwald

Nasenzangen **SPEZIAL** gerade, durchschneidend
Nasal forceps **SPECIAL** straight, cutting through

Größe size	Schaft Länge shaft length	Maul Breite jaw width	Länge length
Gr. 1	120 mm	3,0 mm	8 mm
Gr. 2	120 mm	3,5 mm	11 mm

Art.-Nr.
Cat. No.

64-0209-01
64-0209-02



Nasenzangen **SPEZIAL** 45°, durchschneidend
Nasal forceps **SPECIAL** 45°, cutting through

Gr. 1	120 mm	3,0 mm	8 mm
Gr. 2	120 mm	3,5 mm	11 mm

64-0209-03
64-0209-04



Schmeden



Hartmann



Myles



Struycken Nasenzange

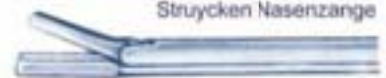

	Schmeden	Hartmann	Myles	Struycken
Fig. 1	64-0605-00	64-0601-00	64-0611-00	64-0614-00
Fig. 2	64-0606-00	64-0602-00	64-0612-00	
Fig. 3	64-0607-00	64-0603-00	64-0613-00	
Fig. 4		64-0604-00		

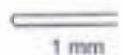

Elevatorium / Elevator Raspatorien / Raspatory



Cottle Elevatorium
elevator
22 cm 65-0108-00



Masing Elevatorium
elevator
20 cm 65-0109-00

McKenty Raspatorium
raspatory
stark gebogen
strong curved
15 cm
3 mm 65-0110-00
4 mm 65-0111-00
5 mm 65-0112-00
6 mm 65-0113-00



McKenty Doppелеlevatorium
double elevator
22 cm 65-0109-10



Joseph-Masing Raspatorium
raspatory
21 cm 65-0115-00



Cottle Raspatorium
raspatory
23 cm 65-0117-00

Pennington Elevatorium
elevator
21 cm 65-0119-00



Killian Elevatorium
elevator
17 cm 65-0118-00



Freer Elevatorium
elevator
stark gebogen
strongly curved
20 cm 65-0116-00



**Elevatorium / Elevator
Raspatorien / Raspatory**



Halle Elevatorium
elevator
16 cm 64-0657-00



Walter Raspatorium
raspatory
14 cm 64-0658-00



Freer Elevatorium
elevator
16 cm, gebogen / curved 64-0680-00
16 cm, gerade / straight 64-0681-00

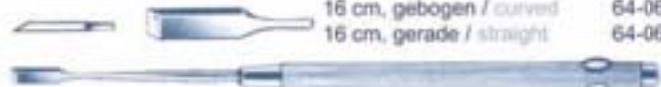

Joseph Raspatorium
raspatory
16 cm 37-0784-00



Raspatorien Raspatory



1 Freer
18 cm
Vierkantgriff
four-side grip
64-0662-00

2 Freer
20 cm
Achtkantgriff
eight-side grip
64-0662-02

3 Freer
18 cm
64-0662-01

4 Killian
22 cm
64-0664-00

5 Killian
18 cm
64-0663-00

6 Freer
19 cm
scharf
sharp 64-0661-00
stumpf
blunt 64-0660-00

7 Sewall
20 cm
64-0575-00

Messer
Knives



-  62
12-0862-00
-  64
12-0864-00
-  65
12-0865-00
-  67
12-0867-00

Mikro-Klingenhalter
micro-blades-holder
12,5 cm
12-0803-00 K



Masing
Ritzmesser
slitting knife

gebogen
curved
65-0106-00

gerade / straight
65-0106-01

65-0106-02 modif.



Cottle
65-0107-00



Fomon
Plastikmesser
spitz,
doppelschneide,
leicht gebogen
Plastic knife
sharp, double-
edge, light
curved
65-0328-00



Brünings
Septummesser
Klinge verstellbar
Septum-knife
blade moveable
64-0650-00



Joseph
Plastikmesser
gerade,
geknöpft
plastic knife
straight, button
end
65-0320-00



Joseph
Plastikmesser
gebogen,
geknöpft
plastic knife
curved, button
end
65-0325-00



Ballenger
Schwingmesser
swife knife
3 mm 64-0640-00
4 mm 64-0641-00

Joseph
Plastikmesser
plastic knife
r 65-0326-01
l 65-0326-02
d 65-0326-03



r = rechts / right
l = links / left
d = beidseitig / bilateral

Raspatorien Raspatory



Uffenorde
10 x 180 mm
37-0703-00



Williger Raspatorium
raspatory
160 x 6,5 mm
37-0776-00



Doyen
Rippenraspatorium
links, 17 cm
costal raspatory
left, 17 cm
37-0740-00



Doyen
Rippenraspatorium
rechts, 17 cm
costal raspatory
rechts, 17 cm
37-0741-00

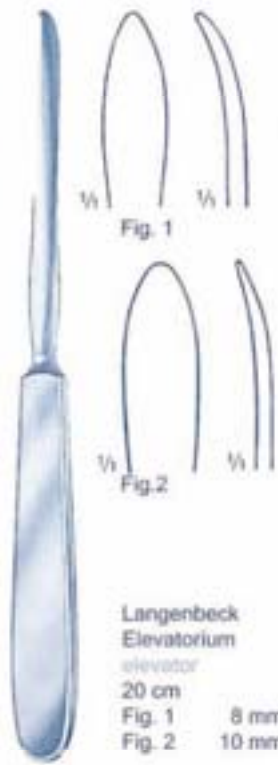

Langenbeck
Elevatorium
elevator
20 cm
Fig. 1 8 mm 37-0801-00
Fig. 2 10 mm 37-0802-00

Langenbeck
19,5 cm
16 mm
37-0711-00



Hämmer
Mallets



**Cottle
Hammer mit
Leichtmetallstiel**
Malleus with light metal
handle
18 cm
1 Seite flach
1 plain face
37-0050-00



Hammer Kunststoff
Malleus plastic
400 g, 26 cm
37-0010-00



**Hammer
Kunststoffbacken**
plastic disks,
interchangeable
140 g
19 cm, 25 mm
37-0006-00



Hajak Hammer
200 g, 21 cm
37-0011-00

Meißel Chisel



Cottle 18,5 cm		
4 mm	65-0144-04	65-0149-04
6 mm	65-0144-06	65-0149-06
7 mm		65-0149-07
9 mm		65-0149-09
12 mm		65-0149-12



Cottle
18 cm
65-0140-16



Cottle 18,5 cm		
4 mm		65-0148-04
6 mm	65-0146-06	65-0148-06
7 mm		65-0148-07
9 mm		65-0148-09
12 mm		65-0148-12

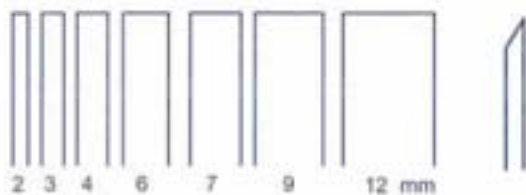

Walter
flach / flat, 19 cm

2 mm	65-0151-02
3 mm	65-0151-03
4 mm	65-0151-04
6 mm	65-0151-06
7 mm	65-0151-07
9 mm	65-0151-09
12 mm	65-0151-12

Walter
hohl / concave, 19 cm

3 mm	65-0150-03
4,5 mm	65-0150-04

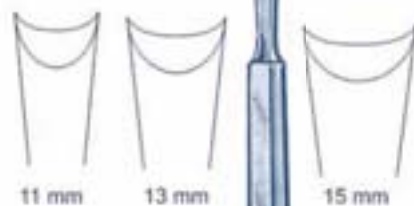

McIndoe
14,5 cm

11 mm	65-0152-11
13 mm	65-0152-13
15 mm	65-0152-15



Meißel

Chisel, Osteotome, Gouges



Masing
gerade
straight
18 cm
65-0200-00



Masing
gebogen links
curved left
18 cm
65-0201-00



Masing
gebogen rechts
curved right
18 cm
65-0202-00



Masing gerade,
Führungsdorn
beidseitig
straight, leading
spindle bilateral
16,5 cm
65-0204-00



Killian
bajonettförmig
bayonet shaped
160 x 5 mm
64-0790-00



Killian-Claus
bajonettförmig
bayonet shaped
160 x 5 mm
64-0795-00



Freer
hohl / hollow
150 x 6 mm
64-0806-00



Freer
flach / flats
150 x 6 mm
64-0816-00

Nasenhaken

Nasal and skin retractors



**Aufrecht
Nasenhaken**
Nasal hook

16 cm
45 mm 65-0169-00
60 mm 65-0170-00



**Waller
Nasenhaken**
Nasal hook

14 cm 65-0171-00



Kilner Nasenhäkchen
Nasal hooklet

10 mm	65-0175-10	scharf / sharp
11 mm	65-0175-11	stumpf / blunt
13 mm	65-0175-13	scharf / sharp



Joseph Hauthäkchen
skin hook
15 cm 65-0178-00



Cottle Hauthäkchen
skin hook
18 cm 65-0179-00



Freer Hauthäkchen
skin hook
15 cm 65-0180-00



Guthrie Hauthäkchen
skin hooklet
12cm
klein / small 24-0150-01
groß / large 24-0150-02

Nasenflügelhaken
Hooks for posterior nares



Cottle
14 cm 65-0120-00



Cottle
20 cm 65-0160-00



Masing
20 cm 65-0161-00



Cottle
scharf
sharp
14 cm
65-0165-00



Cottle-Neivert
links scharf, rechts stumpf
left sharp, right blunt
14 cm
65-0162-00



Cottle
links stumpf, rechts scharf
left blunt, right sharp
14 cm
65-0163-00



Cottle
stumpf-stumpf
blunt-blunt
16 cm
65-0164-00

Nasenhaken / Nasal hooks Hauthäkchen / Skin hooklet



Joseph Nasenhaken
Nasal hook
16 cm
2 mm 65-0185-00
5 mm 65-0186-00
7 mm 65-0187-00
10 mm 65-0188-00



24-0156-00

24-0154-00

24-0152-00

Gillies Hauthäkchen
skin hooklet
18 cm



1/2

Hauthäkchen
skin hooklet
14 cm
24-0157-00



House Doppelhaken
double-ended
hook
15 cm
24-0131-00



Luer Doppelhaken
double-ended
hook
11 cm
70-0118-00



Krause
Nasenpolypenschnürer
nasal polypus snare
26 cm
64-0950-00



Krause-Voss
Nasenpolypenschnürer
nasal polypus snare
26 cm
64-0955-00



Lange
Nasenpolypenschnürer
nasal polypus snare
bayonettförmig
bayonet shaped
24 cm
64-0970-00



Fränkel
Choanenhäkchen
choana hook
22 cm 64-0948-00



Drahtschere HM Einlage
wire cutting scissor HM insert
12,5 cm 15-0549-00

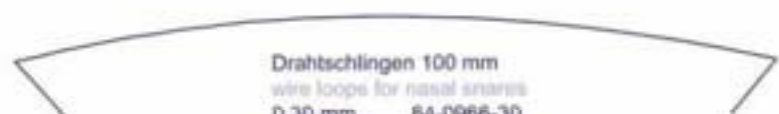

Drahtschlingen 100 mm
wire loops for nasal snares
0,30 mm 64-0966-30
0,36 mm 64-0966-36
0,40 mm 64-0966-40

Nasensägen / Nasal saw Nasenraspel / Nasal rasp

Joseph Nasensägen / Nasenraspel Nasal saw / Nasal rasp



gerade
straight
18 cm
65-0400-00



rechts, bajonettförmig
right, bayonet shaped
19 cm
65-0401-00



links, bajonettförmig
left, bayonet shaped
19 cm
65-0402-00



16 cm
65-0410-00



Cottle Nasenraspel
Nasal rasp
21 cm
65-0414-00

Aufrecht Nasenraspel
Nasal rasp
21 cm
vorwärts / forward 65-0415-02
rückwärts / retrograde 65-0415-04

Nasenraspel
Nasal rasp



Fomon
Widia-Auflage
carbide coating
20 cm 65-0413

Maltz
Widia-Auflage
carbide coating
18 cm 65-0411

65-0411-01



12

65-0413-01



14

65-0411-02

65-0411-03



16

65-0413-02



20

65-0411-04

65-0411-05



24

65-0413-03



30

65-0411-06

65-0411-07



36

65-0413-04



44

65-0411-08

65-0411-09



52

Zähne
teeth

65-0413-05



62

Zähne
teeth

65-0413-10

Nasenraspel Nasal rasp

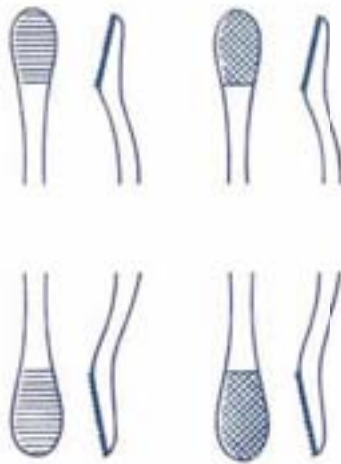

Miller
18 cm
65-0412-01

65-0412-02



Maltz
18 cm
65-0419-00



Fomon
21 cm

fein + grob
fine + coarse 65-0408-04



Masing, 21 cm
fein
fine 65-0408-00



Masing, 21 cm
grob
coarse 65-0408-01



Präparierblett, Kunststoff
preparation tray, plastic
200 x 100 mm
65-0438-00



Rubin Quetschzange
crushing forceps
21 cm
64-0625-00



Zirkel
caliper
65-0436-00



Giertz-Stille
Rippschere
rib scissor
27 cm 65-0440-00



Langenbeck
Knochenhalte-
zange
bone holding forceps
21 cm 65-0441-00

Einweg-Markierer 65-0421-00
single-use marker



Meßlineal aus Metall, 20 cm
measuring ruler, metal
65-0420-00



Cottle-Walsham
Universal Nasenrichtzange, 22,5 cm
septum forceps
65-0431-01



rechts / right 65-0431-02
links / left 65-0431-03



Asch
Nasenrichtzange
septum forceps
22 cm
65-0431-04



Federhalter 15 cm
nibs-holder
65-0425-00
Ersatzfeder
replacement nip
65-0426-00



Glatzel Nasenspiegel
20 x 13 cm
nasal mirror
65-0428-00

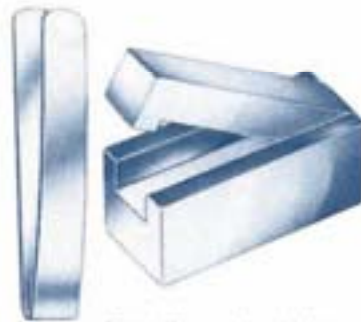

Cottie Knorpelquetscher
cartilage crusher
65-0301-00



Nasenricht-Elevatorium
Nasal fracture elevator

Universal	Dingmann
17 cm	21 cm
65-0430-00	65-0430-02



Boies	Goldmann
18 cm	20 cm
65-0430-04	65-0430-06



Reuter Nasenrachentubus / naso-pharyngeal tube
80-8431-00



Masing Nasenrachentubus / naso-pharyngeal tube
Gr. 1 85-2093-01
Gr. 2 85-2093-02
Gr. 3 85-2093-03

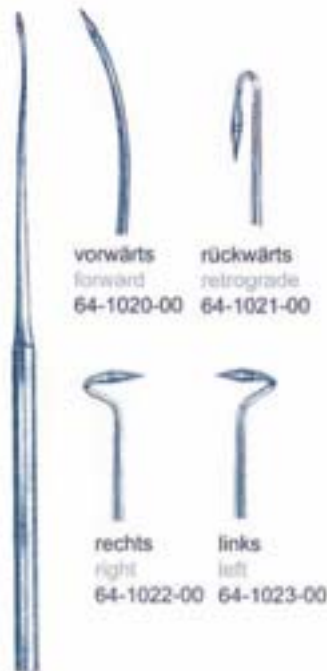

Yankauer
Septumnadel
septum needle



Yankauer Fadenfänger,
16 cm
suture hook, 16 cm
64-1030-00



Belocq
Nasen-Röhrchen
nasal tube 13 cm
64-0786-00



Hartmann
Nasensonde
nasal probe
12,5 cm
64-0789-00

Hypophyse
Hypophysis

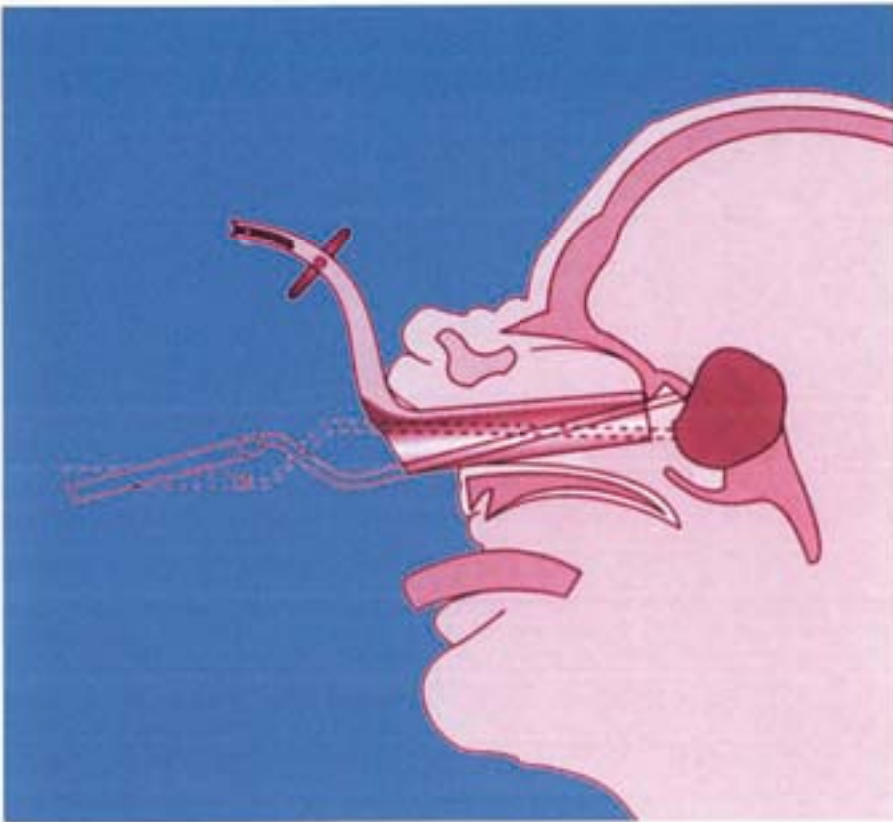

Mikro - Ringkürette
Micro - ring curet

OD 4,0 x 180 mm, gerade,
horizontal 45°, auf Zug schneidend
OD 4,0 x 180 mm, straight,
horizontal 45°, draw cutting

45-0102-01

OD 4,0 x 180 mm, gerade,
vertikal 45°, rechts schneidend
OD 4,0 x 180 mm, straight,
vertical 45°, right cutting

45-0102-02

OD 4,0 x 180 mm, gerade,
vertikal 45°, links schneidend
OD 4,0 x 180 mm, straight,
vertical 45°, left cutting

45-0102-03



Mikro - Ringkürette Micro - ring curet

Mikro - Ringkürette, biegsam, bajonettförmig, horizontal, stumpf, gebogen
Micro - Ringcurette, flexible, bayonet-shaped, horizontal, blunt, curved

vorwärts, lang
forward, long

D 2,0 x 270 mm
D 3,0 x 270 mm
D 4,0 x 270 mm
D 5,0 x 270 mm
D 6,0 x 270 mm
D 7,0 x 270 mm

Nutzlänge
Length usable

150 mm
150 mm
150 mm
150 mm
150 mm
150 mm

Artikel-Nummer
Cat. No.

45-0103-02
45-0103-03
45-0103-04
45-0103-05
45-0103-06
45-0103-07

rückwärts, lang
retrograde, long

D 2,0 x 270 mm
D 3,0 x 270 mm
D 4,0 x 270 mm
D 5,0 x 270 mm
D 6,0 x 270 mm
D 7,0 x 270 mm

150 mm
150 mm
150 mm
150 mm
150 mm
150 mm

45-0113-02
45-0113-03
45-0113-04
45-0113-05
45-0113-06
45-0113-07

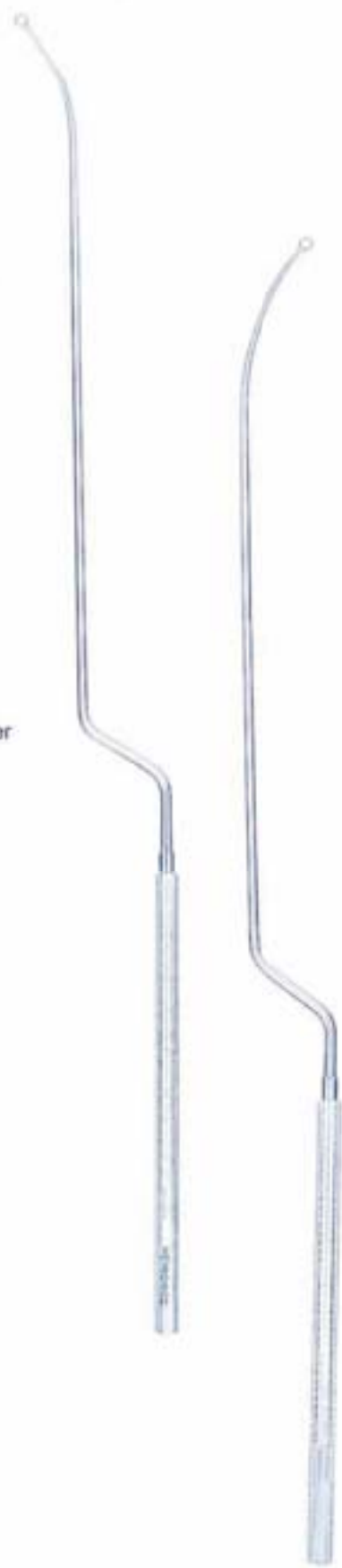

Mikro - Ringkürette
Micro - ring curet

Mikro - Ringkürette, biegsam, bajonettförmig, horizontal, scharf, gebogen
Micro - Ringcurette, flexible, bayonet-shaped, horizontal, sharp, curved

90° vorwärts, kurz
forward, short

	Nutzlänge Length usable	Artikel-Nummer Cat. No.
D 0,8 x 260 mm	125 mm	45-0116-01
D 2,0 x 260 mm	125 mm	45-0116-02
D 3,0 x 260 mm	125 mm	45-0116-03
D 4,0 x 260 mm	125 mm	45-0116-04
D 5,0 x 260 mm	125 mm	45-0116-05
D 6,0 x 260 mm	125 mm	45-0116-06
D 7,0 x 260 mm	125 mm	45-0116-07

90° rückwärts, kurz
retrograde, short

	Nutzlänge Length usable	Artikel-Nummer Cat. No.
D 2,0 x 260 mm	125 mm	45-0117-02
D 3,0 x 260 mm	125 mm	45-0117-03
D 4,0 x 260 mm	125 mm	45-0117-04
D 5,0 x 260 mm	125 mm	45-0117-05
D 6,0 x 260 mm	125 mm	45-0117-06
D 7,0 x 260 mm	125 mm	45-0117-07



Saugrohre Suction tube

Saugrohre für die Hypophyse
Suction tubes for Hypophysis

kniegebogen / curved
Gesamtlänge / Total length 200 mm

Durchmesser / diameter	
1,5 mm	45-0121-00
2,0 mm	45-0122-00
2,5 mm	45-0123-00
3,0 mm	45-0124-00
4,0 mm	45-0126-00



Saugrohre für die Hypophyse
Suction tubes for Hypophysis

mit Fingerring, kniegebogen / curved with fingerring
Gesamtlänge / Total length 290 mm

Durchmesser / diameter	
1,5 mm	45-0131-00
2,0 mm	45-0132-00
2,5 mm	45-0133-00
3,0 mm	45-0134-00
4,0 mm	45-0136-00



Hypophysektomie Instrumente
Pituitary instruments

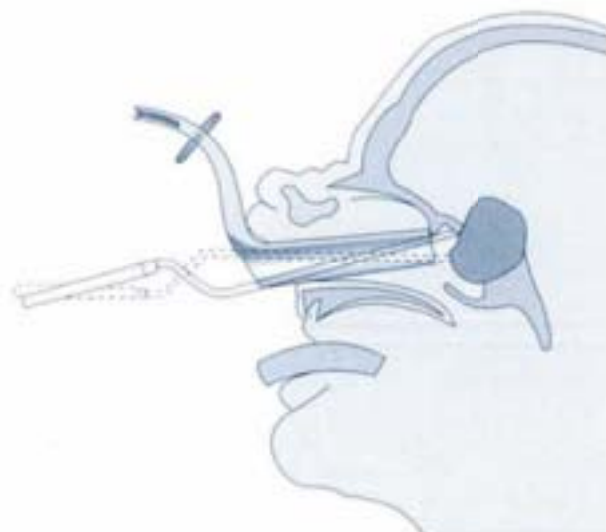

Spekula für trans-sphenoidale Hypophysysektomie
Specula for trans-sphenoidale hypophysectomy

	Größe Size	Artikel-Nummer Cat. No.
Cushing-Landolt	70 x 15 mm	45-0100-07
	90 x 15 mm	45-0100-09
	110 x 15 mm	45-0100-11

Spreizzange zum Spreizen der Spekula



Spreader for specula

	Größe Size	Artikel-Nummer Cat. No.
Landolt	210 mm	45-0100-20

Hypophysektomie Instrumente Pituitary instruments

Spekula für trans-sphenoidale Hypophysyektomie Specula for trans-sphenoidale hypophysectomy

	Größe Size	Artikel-Nummer Cat. No.
Papavero-Caspar	80 x 11 mm	45-0101-08
	90 x 13 mm	45-0101-09
	100 x 15 mm	45-0101-10



Spezial-Modell
für Erwachsene 130 mm

64-0036-00

Spreizer für Spekula 45-0101-08 – 45-0101-10
Spreader for specula



	Schaftlänge Length of shaft	Artikel-Nummer Cat. No.
Landolt	140 mm	55-0583-14

Meißel
Chisel



1/2

	Breite Width	Gesamtlänge Total length	Artikel-Nummer Cat. No.
Cottle	4 mm	185 mm	65-0154-04
	7 mm	185 mm	65-0154-07
	9 mm	185 mm	65-0154-09
	12 mm	185 mm	65-0154-12

Hammer mit einem flachen und einem runden Ende



1/2

Mallet with flat and round end

	Gewicht Weight	Gesamtlänge Total length	Artikel-Nummer Cat. No.
Cottle	240 g	180 mm	37-0050-00

Scheren / Scissors Zangen / Forceps



	Schaftlänge Length of shaft	Artikel-Nummer Cat. No.	
Mikro-Schere, gebogen, horizontal schneidend Micro scissors, horizontal cutting			
Fahlbusch	165 mm	45-6970-00H	
Scharfe Zange Forceps scoop-shaped			
Nicola	165 mm	45-6971-00	
Mikro-Schere, gerade Micro scissors, straight			
Nicola	165 mm	45-6972-00	
Faßzange Forceps			
Yasargil-Nicola	165 mm	45-6973-00	



Blakesley gerade
straight

Schaft Länge shaft length	Maul Höhe jaw height	Breite width	Länge length	Art.-Nr. Cat. No.
------------------------------------	-------------------------------	-----------------	-----------------	----------------------

Blakesley gerade / straight



Fig. 0000C	170 mm	3,5 mm	1,7	8,0 mm	45-0388-00 N
Fig. 0000	170 mm	3,5 mm	2,0	8,0 mm	45-0389-00 N
Fig. 00	170 mm	4,0 mm	2,5	8,0 mm	45-0391-00 N
Fig. 0	170 mm	4,0 mm	3,0	10,0 mm	45-0392-00 N
Fig. 0	170 mm	4,0 mm	3,0	14,0 mm	45-0392-14 N
Fig. 1	170 mm	4,5 mm	3,5	10,0 mm	45-0393-00 N
Fig. 1	170 mm	4,5 mm	3,5	16,0 mm	45-0393-16 N
Fig. 2	170 mm	5,0 mm	4,0	14,0 mm	45-0394-00 N
Fig. 3	170 mm	5,0 mm	4,5	14,0 mm	45-0395-00 N
Fig. 4	170 mm	5,0 mm	6,0	15,0 mm	45-0396-00 N

Blakesley 45°



Fig. 00000	170 mm	3,5 mm	1,7	8,0 mm	45-0368-00 N
Fig. 0000	170 mm	3,5 mm	2,0	8,0 mm	45-0369-00 N
Fig. 00	170 mm	4,0 mm	2,5	8,0 mm	45-0371-00 N
Fig. 0	170 mm	4,0 mm	3,0	10,0 mm	45-0372-00 N
Fig. 1	170 mm	4,5 mm	3,5	10,0 mm	45-0373-00 N
Fig. 2	170 mm	4,5 mm	4,0	13,0 mm	45-0374-00 N
Fig. 3	170 mm	4,5 mm	4,5	14,0 mm	45-0375-00 N
Fig. 4	170 mm	5,0 mm	6,0	14,0 mm	45-0376-00 N



Hypophyse

Nasennebenhöhle
Nasal sinuses



Spülkanülen
Irrigation cannulas

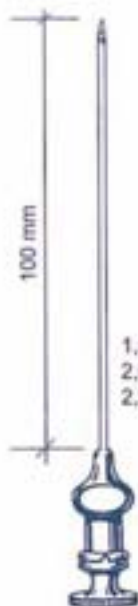

Lichtwitz
Spülkanüle

1,5 mm 64-0521-00
2,0 mm 64-0523-00
2,2 mm 64-0524-00



Vogel
Spülkanüle

64-0526-00
64-0528-00



Eicken
Spülkanüle

64-0531-00
64-0533-00

Spülkanülen / irrigation cannulas
Spülrohre / irrigation tubes
Trokare / trocars
Bougies / bougies



Eicken Spülrohr
Eicken irrigation tube
2,0 mm 64-0499-00
2,5 mm 64-0500-00 64-0503-00
3,0 mm 64-0501-00 64-0504-00



Ritter Bougie
Fig. 1 64-0787-01
Fig. 2 64-0787-02
Fig. 3 64-0787-03
Fig. 4 64-0787-04
Satz 64-0787-00



Lichtwitz Trokar
trocar
1,8 mm
64-0540-00

Nasennebenhöhlen

Silikon K-H Schlauch
Tubo 30 cm
80-0958-00 Luer-Lock

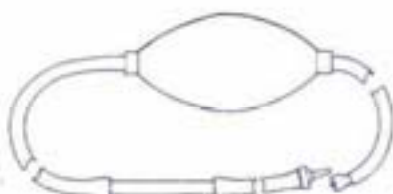
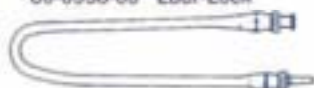

Luer-Lock Anschluß
Luer Lock connector
f 80-0958-13
m 80-0958-14



Clyso
mit / mit Glas 48-1080-02
o. / without Glas 48-1080-00



Muck Nasensaugglas
Muck suction glass
75-0005-00



Siebenmann Spülröhr
Irrigating antrum cannula
innen / inside aussen / outside
2,0 mm 64-0554-00 64-0549-00
2,5 mm 64-0555-00 64-0550-00
3,0 mm 64-0556-00 64-0551-00
3,5 mm 64-0557-00 64-0552-00



Watson-Williams
Watson cannula
15 cm 1,7 mm
64-0506-00



Kilian Spülröhr
Kilian cannula
17 cm
1,5 mm 64-0509-15

Kilian Sonde
Kilian probe
17 cm
1,0 mm 64-0509-10
s. S. 5-24
s. p. 5-24



Faulkner
Kieferhöhlenmeißel
antrum gouge
64-0578-00

Brawley
Kieferhöhlenraspel
antrum rasping
64-0579-00



Sternberg
Lippenhalter
lip retractor
74-0370-00



Heddrich
Lippenhalter
lip retractor
74-0374-00



Langenbeck
Wundhaken
antrum retractor
40 mm x 10 mm
24-0166-00

Orbitaschützer, klein
orbital protector, small
64-0580-00
groß / large
64-0581-00



Brünings-Brunk
Kieferhöhlenhaken
antrum retractor
64-0570-00



Faulkner
Kieferhöhlen - Kürette
antrum curette
21 cm
64-0576-00

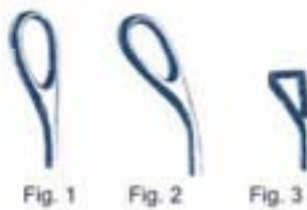

Fig. 1 Fig. 2 Fig. 3



Fig. 4 Fig. 5 Fig. 6

Coakley Kieferhöhlen-Kürette 17 cm
antrum curette

- | | |
|--------|------------|
| Fig. 1 | 64-0576-11 |
| Fig. 2 | 64-0576-12 |
| Fig. 3 | 64-0576-13 |
| Fig. 4 | 64-0576-14 |
| Fig. 5 | 64-0576-15 |
| Fig. 6 | 64-0576-16 |

Coakley Doppel-Kürette 20 cm
antrum curette double

- | | |
|----------|------------|
| Fig. 1+2 | 64-0576-21 |
| Fig. 3+6 | 64-0576-22 |
| Fig. 4+5 | 64-0576-23 |



Thornwald
Kieferhöhlenbohrer
antrum drill
64-0577-00

Scharfe Löffel
Curette



Voikmann
Scharfer Löffel
curette
17 cm

0000	37-0507-00
000	37-0508-00
00	37-0509-00
0	37-0510-00
1	37-0511-00
2	37-0512-00

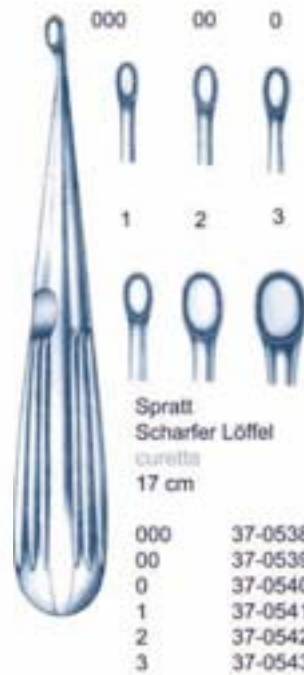

Spratt
Scharfer Löffel
curette
17 cm

000	37-0538-00
00	37-0539-00
0	37-0540-00
1	37-0541-00
2	37-0542-00
3	37-0543-00

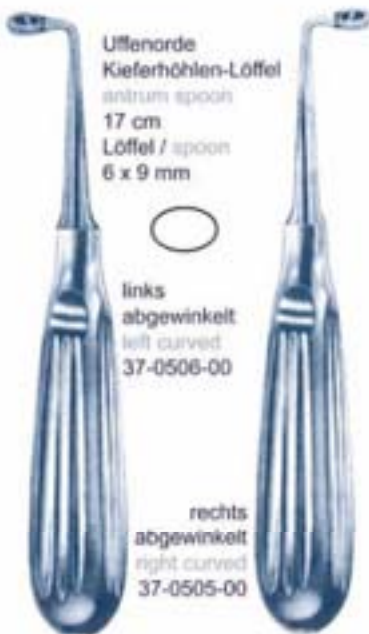

Uffenorde
Kieferhöhlen-Löffel
antrum spoon
17 cm
Löffel / spoon
6 x 9 mm



links
abgewinkelt
left curved
37-0508-00

rechts
abgewinkelt
right curved
37-0505-00

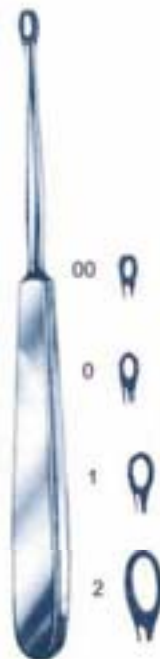

Williger
Scharfer Löffel
curette
17 cm

00	00	37-0550-00
0	0	37-0551-00
1	1	37-0552-00
2	2	37-0553-00



Halle
Scharfer Löffel
biegsam
curette, malleable
21 cm

1	37-0501-00
2	37-0502-00
3	37-0503-00

Küretten / Curette Watteträger / Cotton applicator



Kieferhöhlen - Sonde / frontal sinus probe
180 x 2 mm 12-0805-00



Antrum Kürette
antrum curette 16,5 cm
rückwärts schneidend
backward cutting
64-0575-01
vorwärts schneidend
forward cutting
64-0575-02

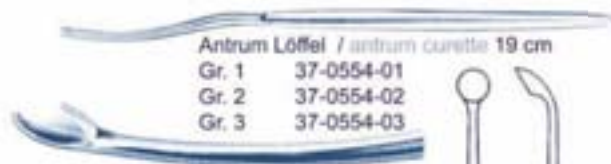

Antrum Löffel / antrum curette 19 cm
Gr. 1 37-0554-01
Gr. 2 37-0554-02
Gr. 3 37-0554-03



Antrum Löffel 19 cm
antrum spoon
rund 37-0555-00
oval 37-0555-02



NNH Sichelmesser 19 cm
nasal sickle knife



34-0594-04



64-0594-00



doppelt gerieft
double spiral
biegsam / pliable



dreikant gerieft
triangular



gerieft
rough

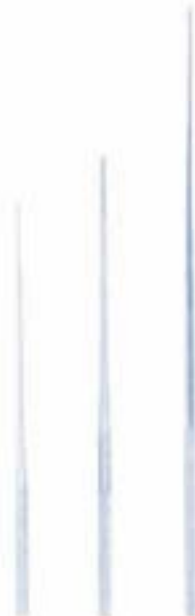

7,5 cm		1,0 mm	60-0222-00	0,8 mm	60-0223-04
12,0 cm				0,8 mm	60-0217-12
12,0 cm	1,2 mm	1,2 mm	60-0219-00	1,2 mm	60-0218-00
14,0 cm	1,2 mm	1,2 mm	60-0221-00		
16,0 cm	1,2 mm	1,2 mm	60-0220-00		

Kieferhöhlenstanzen
Antrum punch



Hajek-Koffler Kieferhöhlenstanze
antrum punch, revolving handle
Schaft 170 mm, 360° drehbar 45-0645-00
Schaft 170 mm, 360° rotabile
Schaft 150 mm, 360° drehbar 45-0645-02
Schaft 170 mm, 360° rotabile



Ferris-Smith Kieferhöhlenstanze
antrum punch
Schaft / handle 180 mm
Fig. 1 4 mm nach oben schneidend
upward cutting 45-0560-00
Fig. 2 4 mm nach unten schneidend
downward cutting 45-0561-00



Hajek-Claus Kieferhöhlenstanze
antrum punch
Schaft / handle 80 mm
200 mm 45-0505-00



Kerrison Kieferhöhlenstanze
antrum punch
Schaft / handle 90 mm
Fig. 1 45-0520-00
Fig. 2 45-0521-00
Fig. 3 45-0522-00



Hajek Kieferhöhlenstanze
antrum punch
Schaft / handle 130 mm
Fig. 1 45-0512-00
Fig. 2 45-0514-00

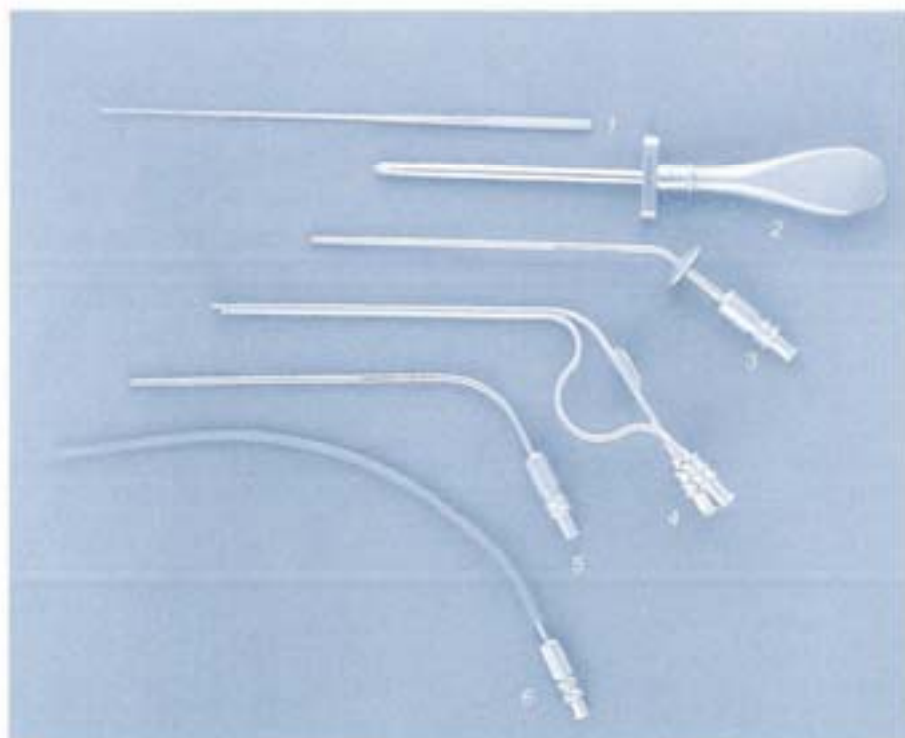

1	Watteträger / cotton applicator	60-0225-00
2	Trokar / trocar für / for 4,0 mm Optik	11-0180-00
3	Sauger / suction	11-0181-00
4	Spülsauger / irrig. suction	63-0408-00
5	Sauger kniegebogen / suction angled	11-0183-00
6	Absaugkatheter / suction catheter	11-0184-00



Brillina Optik, Schaft 4,0 mm
 Brillina optic, handle 4,0 mm
 0° 11-4000-00 W
 30° 11-4030-00 W
 70° 11-4070-00 W



Brillina Optik , Schaft 2,7 mm
Brillina optic, handle 2,7 mm
180 mm
0° 11-4200-00 W



Brillina Optik, Schaft 2,7 mm
Brillina optic, handle 2,7 mm
180 mm
30° 11-4230-00 W



Brillina Optik, Schaft 2,7 mm
Brillina optic, handle 2,7 mm
180 mm
70° 11-4270-00 W

Optische Sinuskopiezange
telescope forceps
flexibel / flexible
11-0189-00



Optische Sinuskopiezange
telescope forceps
11-0186-00

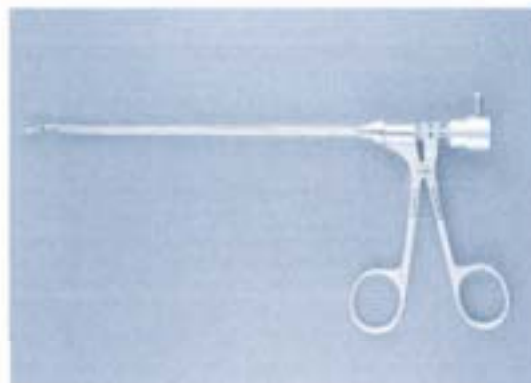

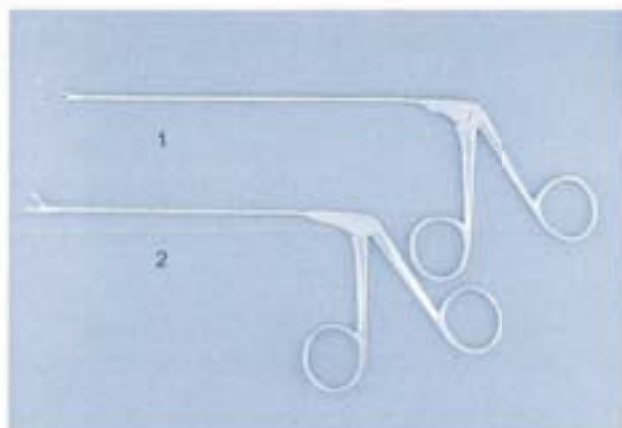

- | | | |
|---|--|------------|
| 1 | PE - Zange m. Blakesley-Maul, Nutzlänge 15 cm 64-0596-00
PE - forceps Blakesley, working length 15 cm | |
| 2 | PE - Zange m. Doppelöffel-Maul, Nutzlänge 15 cm
PE - biopsy-forceps, working length 15 cm | 45-6978-00 |



Saug- u. Spülhandgriff mit 2-Wegehahn, drehbarem Schaft, universal, für Endoskope 4,0 mm Durchmesser, 0 bis 70° Blickrichtung
Suction and irrigation handle with 2-way stop cock, rotatable sheath, universal, for endoscopes 4 mm diameter, 0° - 70°
11-0402-00

Saug- u. Spülhandgriff mit 2-Wegehahn, drehbarem Schaft für Endoskope 4,0 mm Durchmesser, 30° Blickrichtung
Suction and irrigation handle with 2-way stop cock, rotatable sheath, for endoscopes 4 mm diameter, 30°
11-0402-01

Saug- u. Spülhandgriff mit 2-Wegehahn, drehbarem Schaft, universal, für Endoskope 2,7 mm Durchmesser, 188 mm Nutzlänge, 0 bis 70° Blickrichtung
Suction and irrigation handle with 2-way stop cock, rotatable sheath, universal, for endoscopes 2.7 mm diameter, 188 mm effective length, 0° - 70°
11-0402-03

Saug- u. Spülhandgriff mit 2-Wegehahn, drehbarem Schaft für Endoskope 2,7 mm Durchmesser, 188 mm Nutzlänge, 30° Blickrichtung
Suction and irrigation handle with 2-way stop cock, rotatable sheath, for endoscopes 2.7 mm diameter, 188 mm effective length, 30°
11-0402-07



Wagner Zerstäuber
nasal atomizer
für Nase
mit Schraubglas
12 cm
48-1012-00

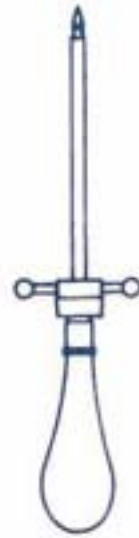

Trokar / trocar
mit Gummidichtung
with rubber-seal

11-0410-00

Trokar / trocar
mit Silikondichtung
with silicone seal

11-0410-04



Michel
Postrhinoskopie Spiegel
post-rhinoscopic mirror
K1 64-0599-01
K2 64-0599-02
K3 64-0599-03
K4 64-0599-04



Ostium Doppelinstrument
maxillary sinus ostium seeker
Enden kugelförmig / double-ended
1,2 mm und 2,0 mm Ø
19 cm
64-0676-00



Saugrohr konisch
suction tube conical

160 mm
3:6 mm 29-1150-00
4:7 mm 29-1151-00
5:8 mm 29-1152-00

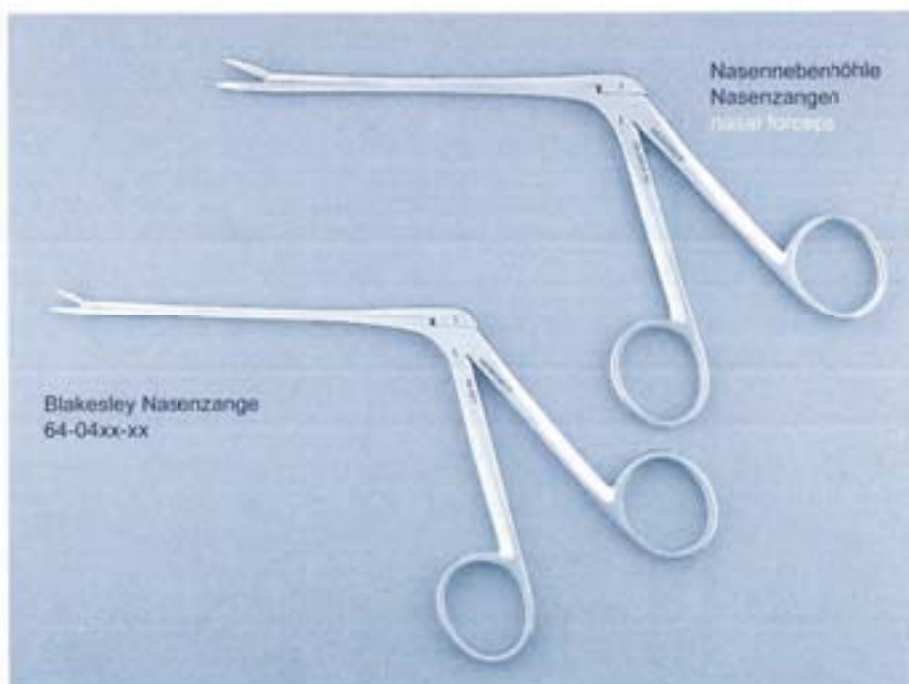

Blakesley gerade straight



	Schaft Länge shaft	Maul Höhe jaw height	Breite width	Länge length	Art-Nr. Cat. No.
Fig. 00000	120 mm	3,5 mm	1,7	8,0 mm	64-0398-00 H
Fig. 0000	120 mm	3,5 mm	2,0	8,0 mm	64-0399-00 H
Fig. 00	120 mm	4,0 mm	2,5	8,0 mm	64-0401-00 H
Fig. 0	120 mm	4,0 mm	3,0	10,0 mm	64-0402-00 H
Fig. 1	120 mm	4,5 mm	3,5	10,0 mm	64-0403-00 H
Fig. 2	120 mm	5,0 mm	4,0	14,0 mm	64-0404-00 H
Fig. 3	120 mm	5,0 mm	4,5	14,0 mm	64-0405-00 H
Fig. 4	120 mm	5,0 mm	6,0	15,0 mm	64-0406-00 H

Blakesley 45°



Fig. 00000	120 mm	3,5 mm	1,7	8,0 mm	64-0408-00 H
Fig. 0000	120 mm	3,5 mm	2,0	8,0 mm	64-0409-00 H
Fig. 00	120 mm	4,0 mm	2,5	8,0 mm	64-0411-00 H
Fig. 0	120 mm	4,0 mm	3,0	10,0 mm	64-0412-00 H
Fig. 1	120 mm	4,5 mm	3,5	10,0 mm	64-0413-00 H
Fig. 2	120 mm	4,5 mm	4,0	13,0 mm	64-0414-00 H
Fig. 3	120 mm	4,5 mm	4,5	14,0 mm	64-0415-00 H
Fig. 4	120 mm	5,0 mm	6,0	14,0 mm	64-0416-00 H

Blakesley 45°, mit langem Löffel / with long spoon

Fig. 2	120 mm	4,5 mm	4,0	20,0 mm	64-0414-20 H
--------	--------	--------	-----	---------	--------------



Blakesley 90°, mit stumpfen Maul / with blunt jaw

Fig. 0	120 mm	4,0 mm	3,0	10,0 mm	64-0429-00 HR
Fig. 1	120 mm	4,5 mm	3,5	10,0 mm	64-0430-00 HR
Fig. 2	120 mm	4,5 mm	4,0	13,0 mm	64-0431-00 HR
Fig. 3	120 mm	4,5 mm	4,5	14,0 mm	64-0432-00 HR



Absaugung oben

Blakesley gerade mit Absaugung oben

Fig. 00	120 mm x 4,0 mm,	2,5 x	8,0 mm	64-0401-00 HO
Fig. 0	120 mm x 4,0 mm,	3,0 x	10,0 mm	64-0402-00 HO
Fig. 1	120 mm x 4,5 mm,	3,5 x	10,0 mm	64-0403-00 HO



Blakesley 45° mit Absaugung oben

Fig. 00	120 mm x 4,0 mm,	2,5 x	8,0 mm	64-0411-00 HO
Fig. 0	120 mm x 4,0 mm,	3,0 x	10,0 mm	64-0412-00 HO
Fig. 1	120 mm x 4,5 mm,	3,5 x	10,0 mm	64-0413-00 HO



Absaugung unten

Blakesley gerade mit Absaugung unten

Fig. 00	120 mm x 4,0 mm,	2,5 x	8,0 mm	64-0401-00 HU
Fig. 0	120 mm x 4,0 mm,	3,0 x	10,0 mm	64-0402-00 HU
Fig. 1	120 mm x 4,5 mm,	3,5 x	10,0 mm	64-0403-00 HU



Blakesley 45° mit Absaugung unten

Fig. 00	120 mm x 4,0 mm,	2,5 x	8,0 mm	64-0411-00 HU
Fig. 0	120 mm x 4,0 mm,	3,0 x	10,0 mm	64-0412-00 HU
Fig. 1	120 mm x 4,5 mm,	3,5 x	10,0 mm	64-0413-00 HU





Blakesley gerade durchschneidend

Größe	Schaft Länge	Maul Höhe	Breite	Länge	Art.-Nr.
Fig. 00	120 mm	4,0 mm	2,5	8,0 mm	64-0401-00 HD
Fig. 0	120 mm	4,0 mm	3,0	10,0 mm	64-0402-00 HD
Fig. 1	120 mm	4,5 mm	3,5	10,0 mm	64-0403-00 HD
Fig. 2	120 mm	5,0 mm	4,0	14,0 mm	64-0404-00 HD



Blakesley 45° durchschneidend

Fig. 00	120 mm	4,0 mm	2,5	8,0 mm	64-0411-00 HD
Fig. 0	120 mm	4,0 mm	3,0	10,0 mm	64-0412-00 HD
Fig. 1	120 mm	4,5 mm	3,5	10,0 mm	64-0413-00 HD
Fig. 2	120 mm	4,5 mm	4,0	14,0 mm	64-0414-00 HD



Blakesley gerade durchschneidend mit Absaugung oben

Fig. 00	120 mm x	4,0 mm,	2,5	8,0 mm	64-0401-00 HDO
Fig. 1	120 mm x	4,5 mm,	3,6	10,0 mm	64-0403-00 HDO
Fig. 2	120 mm x	5,0 mm,	4,8	14,0 mm	64-0404-00 HDO



Blakesley 45° durchschneidend mit Absaugung oben

Fig. 00	120 mm	4,0 mm	2,5	8,0 mm	64-0411-00 HDO
Fig. 1	120 mm	4,5 mm	3,6	10,0 mm	64-0413-00 HDO
Fig. 2	120 mm	4,5 mm	4,8	14,0 mm	64-0414-00 HDO



Blakesley gerade durchschneidend mit Absaugung unten

Fig. 00	120 mm x	4,0 mm,	2,5 x	8,0 mm	64-0401-00 HDU
Fig. 1	120 mm x	4,5 mm,	3,6 x	10,0 mm	64-0403-00 HDU
Fig. 2	120 mm x	5,0 mm,	4,8 x	14,0 mm	64-0404-00 HDU



Blakesley 45° durchschneidend mit Absaugung unten

Fig. 00	120 mm	4,0 mm	2,5	8,0 mm	64-0411-00 HDU
Fig. 1	120 mm	4,5 mm	3,6	10,0 mm	64-0413-00 HDU
Fig. 2	120 mm	4,5 mm	4,8	14,0 mm	64-0414-00 HDU



durchschneidend	D	
rundes Maul		R
m. Absaugung oben		O
m. Absaugung unten		U
m. durchschneidend m. Absaugung oben	DO	
m. durchschneidend m. Absaugung unten	DU	



Nasenzangen SPEZIAL gerade, durchschneidend

Größe	Schaft Länge	Maul Breite	Länge
Gr. 1	130 mm	3,0 x	08,0
Gr. 2	130 mm	3,5 x	11,5

Art.-Nr.

64-0209-01
64-0209-02



Nasenzangen SPEZIAL 45°, durchschneidend

Gr. 1	130 mm	3,0 x	08,0
Gr. 2	130 mm	3,5 x	11,5

64-0209-03
64-0209-04



Schmeden Nasenzange



Hartmann Nasenzange



Myles Nasenzange



Struycken Nasenzange



	Schmeden	Hartmann	Myles	Struycken
Fig. 1	64-0605-00	64-0601-00	64-0611-00	64-0614-00
Fig. 2	64-0606-00	64-0602-00	64-0612-00	
Fig. 3	64-0607-00	64-0603-00	64-0613-00	
Fig. 4		64-0604-00		

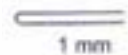



Takahashi
scharfe Nasenzange
nasal forceps, sharp



3x10 mm
64-0637-00



3x10 mm
64-0636-00



Stanze, retrograd
punch, retrograde



aufwärts / up
2,5 mm 45-0523-01 U



rechts / right
2,5 mm 45-0523-05 U



links / left
2,5 mm 45-0523-06 U



Andere Größen auf Anfrage
Other sizes on request



Anthony Fischer
Antrumkatheter
Anthony Fischer
antrumcatheter
Ch 14
60-8480-00



1	Nasenschere nasal scissors	gerade straight	64-0590-00
2	Nasenschere nasal scissors	rechts gebogen curved right	64-0590-02
3	Nasenschere nasal scissors	links gebogen curved left	64-0590-03



1	Doppelöffelzange biopsy forceps	aufgebogen, horizontal upwards curved, horizontal	64-0594-07
2	Doppelöffelzange biopsy forceps	aufgebogen, vertikal upwards curved, vertical	64-0594-12
3	Doppelöffelzange biopsy forceps	retrograd, horizontal retrograde, horizontal	64-0594-10

Sinuskopie Sinuscopy

Saug- und Spülgriff
suction / irrigation handle
11-0402-00

Siehe Seite 5-10
ref. page 5-10

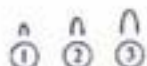

Cilelli Knochenstanze
durchschneidend
antrum punch
through cutting

1 45-0480-00
2 45-0481-00
3 45-0482-00

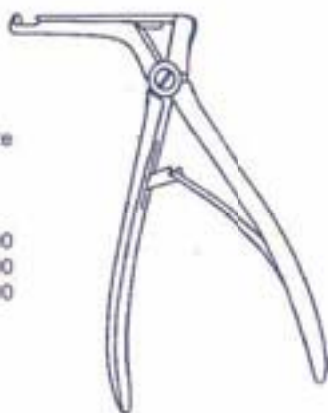

Hajek Keilbeinstanze
sphenoid punch
14 cm, 3,5 x 3,7 mm, 90°
nach oben schneidend
upbiting
45-0513-00

nach unten schneidend
downbiting
45-0513-02

nach oben rückwärts schneidend
upbiting backwards
45-0513-03

Hajek-Kofler
14 cm, 2,0 x 2,0, 45°
vorwärts schneidend
forward cutting
45-0512-45

Hajek-Kofler Knochenstanze
sphenoid punch
14 cm, 3,5x3,7 mm, 45°

nach unten rückwärts schneidend
downbiting backwards cutting
45-0513-04

nach oben vorwärts schneidend
upbiting forward cutting
45-0513-05

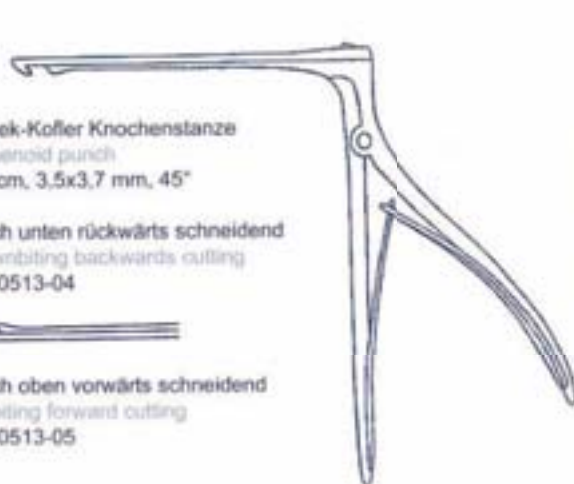

Beyer Attikus-Stanze
45° nach oben schneidend, 2 mm
Schaftlänge 19 cm
antrum punch
45° upbiting
shaft length 19 cm

nach oben / up 45-0527-00
retrograd / retrograde 45-0527-02



Sinuskopie
Sinuscopy

Nasenspekulum Spezialmodell

nasal specula

13 cm

Für Kinder / for children
64-0099-00

Für Erwachsene / for adults
64-0036-00



Antrum-Kürette

antrum spoon

19 cm

Vorwärts schneidend

forward cutting

1 64-0575-02

3 64-0575-04

Rückwärts schneidend

backward cutting

2 64-0575-01

4 64-0575-03

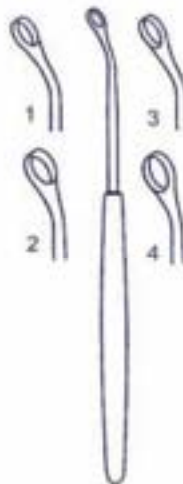

33%

Antrum-Löffel

antrum spoon

19 cm,

1 rund / round 37-0555-00

2 oval 37-0555-02

3 oval 37-0555-04



Sinushöhlen-Löffel

sinus frontal spoon

19 cm

4 55° oval 37-0557-02

5 90° oval 37-0557-04



Antrum-Löffel

antrum spoon

19 cm oval

1 retrograd

37-0554-01

2 retrograd

37-0554-02

3 vorwärts / forward

37-0554-03

4 vorwärts / forward

37-0554-04

Sinuskopie



Probeexcisionszange
biopsy forceps
15 cm,
ovaler Löffel oval spoon 2,5 mm
45-6978-00

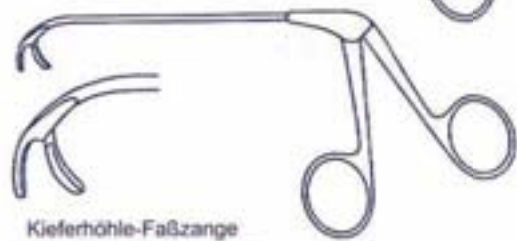

Kieferhöhle-Faßzange
antrum grasping forceps
10 cm, bewegliches Maulteil 120°
64-0211-05



Doppellöffelzange
Schaftlänge: 130 mm
biopsy forceps

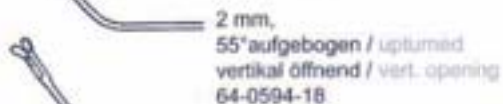

2 mm,
55°aufgebogen / upturned
vertikal öffnend / vert. opening
64-0594-16

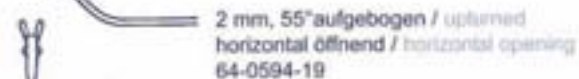

2 mm, 55°aufgebogen / upturned
horizontal öffnend / horizontal opening
64-0594-19



2 mm, 90°aufgebogen / upturned
vertikal öffnend / vert. opening
64-0594-22

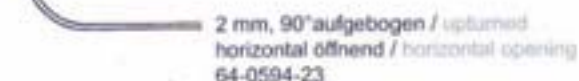

2 mm, 90°aufgebogen / upturned
horizontal öffnend / horizontal opening
64-0594-23



Doppellöffelzange
biopsy forceps



2,5 mm, 110° aufgebogen
upturned
horizontal öffnend
horizontal opening
64-0594-10



2,5 mm, 110° aufgebogen
upturned,
vertikal öffnend / vert.
opening
64-0594-14



2,5 mm, 70° aufgebogen
upturned
horizontal öffnend
horizontal opening
64-0594-13



2,5 mm, 70° aufgebogen
upturned,
vertikal öffnend / vert.
opening, kurz / short
64-0594-15



Polypenfaßzange
polyp grasping forceps
binnenförmiges Maul 3x1,5 mm
pair shaped
horizontal öffnend, 80° nach
oben / up 64-0211-58
links / left 64-0211-59
rechts / right 64-0211-60

Sinuskopie

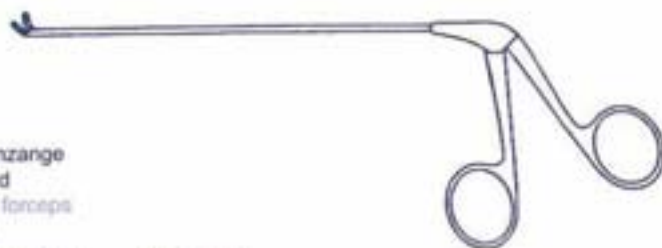

Blakesley Nasenzange
durchschneidend

Blakesley nasal forceps
through cutting

gerade / straight, 3,0 mm 64-0213-50
gerade / straight, 3,5 mm 64-0213-51

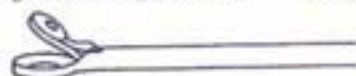

45°, 3,0 mm 64-0213-55
45°, 3,5 mm 64-0213-56



Grünwald Nasenzange
durchschneidend

Grünwald nasal forceps
through cutting

gerade / straight, 8,0 x 3,0 mm 64-0209-01
gerade / straight, 11,5 x 3,5 mm 64-0209-02

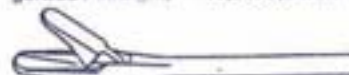

45°, 8,0 x 3,0 mm 64-0209-03
45°, 11,5 x 3,5 mm 64-0209-04

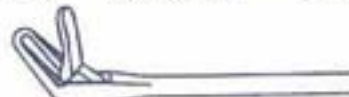

Antrumstanze 10 cm, 90°
antrum punch 10 cm, 90°

rechts / right 64-0214-04



links / left 64-0214-05



Antrumstanze, rund 18 cm,
antrum punch, round 18 cm
3,5 mm 64-0214-06



Sinuskopie



Ostrum Antrumstanze 10 cm,
drehbar, rückwärts schneidend
antrum punch, 10 cm
upside backwards cutting

Medium 64-0217-01
f. Kinder 64-0217-11



Antrum-Saugstanze 10 cm
Zentraler integrierter Saugkanal
antrum suction punch, 10 cm
integrated suction channel
Schaft 4,0 mm

nach oben rückwärts
upside backwards
64-0218-01
nach rechts rückwärts
backward right
64-0218-02



Antrum-Saugstanze 10 cm
Zentraler integrierter Saugkanal
aufgebogen
antrum suction punch
integrated suction channel
upturned

nach oben rückwärts
upside backwards
64-0218-05



Biopsiezange 10 cm
biopsy forceps
Zentraler integrierter
Saugkanal
integrated suction channel

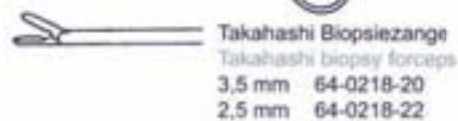

Takahashi Biopsiezange
Takahashi biopsy forceps
3,5 mm 64-0218-20
2,5 mm 64-0218-22

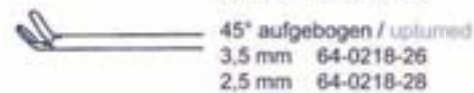

45° aufgebogen / upturned
3,5 mm 64-0218-26
2,5 mm 64-0218-28



Blakesley Biopsiezange
Blakesley biopsy forceps
3,5 mm 64-0218-30
2,5 mm 64-0218-32

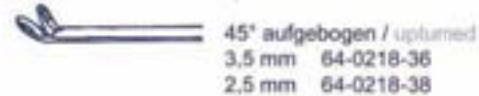

45° aufgebogen / upturned
3,5 mm 64-0218-36
2,5 mm 64-0218-38



Antrum-Saugstanze 10 cm
zentraler integrierter Saugkanal
Schaft 5,0 mm
antrum suction punch 10 cm
shaft 5,0 mm

nach oben rückwärts
upward backwards
64-0218-40
nach links rückwärts
left backwards
64-0218-41
nach rechts rückwärts
right backwards
64-0218-42

Sinuskopie



Blakesley Kieferhöhle PE-Zange
Blakesley antrum punch
19 cm



gerade / straight
45-6901-40



60° aufgebogen / upturned
45-6901-41



90° aufgebogen / upturned
45-6901-42

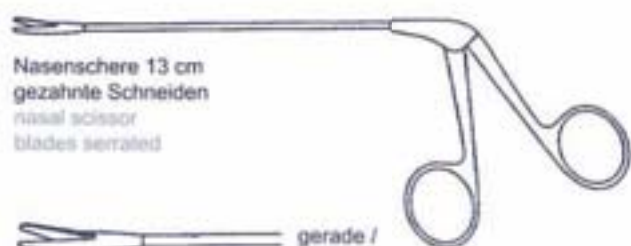

Nasenschere 13 cm
gezahnte Schneiden
nasal scissor
blades serrated



gerade /
straight
64-0591-00



links gebogen /
curved left
64-0591-03



rechts gebogen /
curved right
64-0591-02

Nasensonde,
kniegebogen / bent
16 cm

64-0509-16



Kilian
Nasensonde, / probe
leicht gebogen / light bend
17 cm

64-0509-10



Nasenstopfer,
zum Einbringen der
Tamponade / to insert nasal tampon
18 cm

64-0947-00



Adenotomie
Adenotomy



Ringmesser Adenoid curettes



A Negus Ringmesser
Adenoid curettes
22 cm

0	68-0300-00
1	68-0301-00
2	68-0302-00
3	68-0303-00
4	68-0304-00
5	68-0305-00

B Kratz Ringmesser
Adenoid curettes
22 cm

0	68-0290-00
1	68-0291-00
2	68-0292-00
3	68-0293-00
4	68-0294-00
5	68-0295-00

C Beckmann Ringmesser
Adenoid curettes
22 cm

1	68-0271-00
2	68-0272-00
3	68-0273-00
4	68-0274-00
5	68-0275-00

Adenotomie



Frenzel Korbspatel, 17 cm
cage blade
24 mm breit 68-0306-00



Zerstäuber
für Rachen
mit Glas ohne
Gebläse,
12 ccm
Atomizer for
through
with glass,
without blower
48-1014-00



Hofer
Gaumenbogenhaken
palatine arch hook
24 cm
74-0371-00



Nager
Gaumenhaken
softplate hook
23 cm
68-0012-01



La Force Adenotom, 22 cm
adenotom, 22 cm
Fig. 1 8 mm breit / deep 68-0308-00
Fig. 2 10 mm breit / deep 68-0309-00
Fig. 3 12 mm breit / deep 68-0310-00
Fig. 4 16 mm breit / deep 68-0311-00
Fig. 5 18 mm breit / deep 68-0312-00

Adenotomie

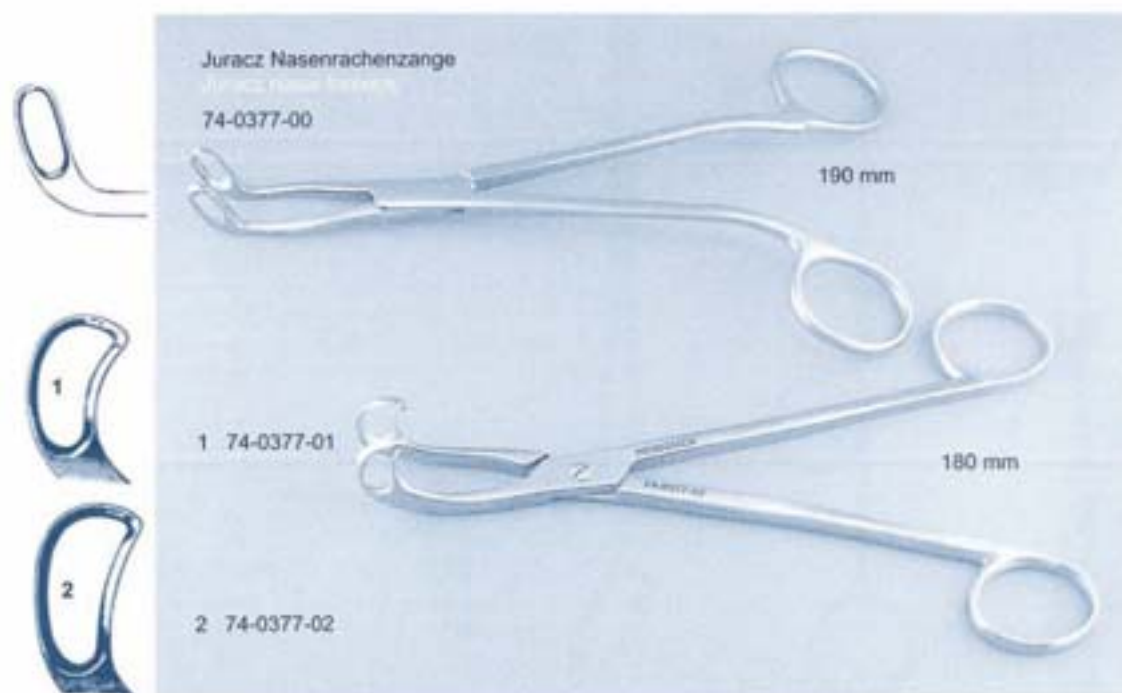

Hopmann Velotraktor, 78 cm
mit Schlauch und Oliven

Velum retractor

with tube and olive

komplett / complete

74-0375-00

Schlauch m. 2 Oliven, alleine

tube with 2 olives, only

74-0375-16



**Post-Rhinoskopie Spiegel
beweglich**
post-rhinoscopy-mirror
movable

K1	12 mm OD 64-0599-01
K2	14 mm OD 64-0599-02
K3	16 mm OD 64-0599-03
K4	18 mm OD 64-0599-04



Nasenwatteträger
nasal cotton applicator
22 cm 74-0446-00



**Juracz
Nasen-Rachen-
Tamponadezange**
nasal pharyngeal
dressing forceps
19 cm 68-0330-00



Haslinger Gaumensegelhalter
velum holder
170 mm 74-0368-00 74-0369-00

Naserrachenzangen
Naso-pharyngeal forceps



**Schmeden
Naserrachenzange**
Naso-pharyngeal forceps
68-0111-00

Schmeden Naserrachenzange gebogen
Naso-pharyngeal forceps, curved



5,5 mm

68-0112-01



7,0 mm

68-0112-02



8,5 mm

68-0112-03

Hartmann Naserrachenzange
Naso-pharyngeal forceps



13mm

68-0101-00



15mm

68-0102-00



17mm

68-0103-00

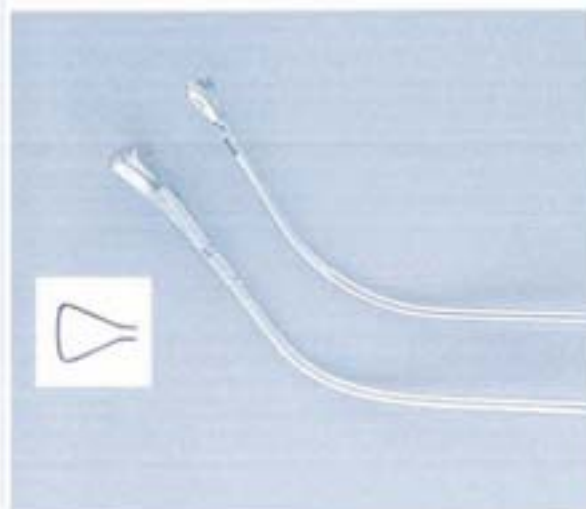

Jaitho Naserrachenzange
Naso-pharyngeal forceps
horizontal 74-0377-08
vertikal 74-0377-07

**Adeno-Conchoton
Naserrachenzange**
Naso-pharyngeal forceps
68-0100-00





Adenotomie

Tonsillektomie
Tonsillectomy



Mundsperrer / Mouth gag
Bruststütze / Chest support



Kilner-Doughty
Griff allein, rechts, mit
bewegl.
Zahnhaken und
Silikonschutz
handle only, right, with
moveable dental hook
and silicone protection
74-0505-00



Mc Ivor
74-0520-00



Negus
Bruststütze
chest support
Höhe / height

140 mm	74-0500-00
110 mm	74-0500-02
85 mm	74-0500-04

Mundsperrer Mouth gag



Davis-Boyle
links, mit Zahnhaken u.
Silkenschutz
left, with dental hook
and silicone protection
74-0505-04

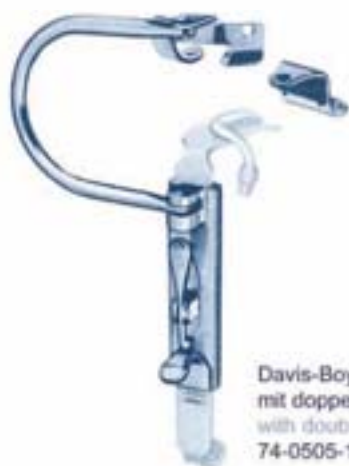

Davis-Boyle
mit doppelter Gebissplatte
with double plate
74-0505-12

mit einfacher Gebissplatte
with simple plate
74-0505-14



Selbstspreizend,
selbständig nachstellende Sperre
automatic adjusted ratchet
90 mm 74-0526-00
110 mm 74-0527-00
130 mm 74-0528-00



Dingmann
komplett mit drei
auswechselbaren
Zungenspateln
complete along with three
changeable tongue spatulas
Fig. 1 = 24 x 62 mm
Fig. 2 = 28 x 65 mm
Fig. 3 = 31 x 75 mm
74-0529-00

Spatel
Tongue blades



Abbildungen 1:1
pictures 1:1

Herberhold

- Fig. 1 74-0561-00
- Fig. 2 74-0562-00
- Fig. 3 74-0563-00
- Fig. 4 74-0564-00
- Fig. 5 74-0565-00

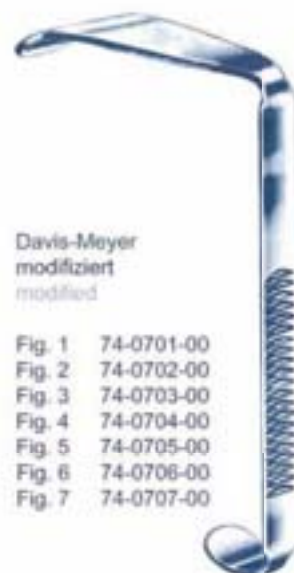
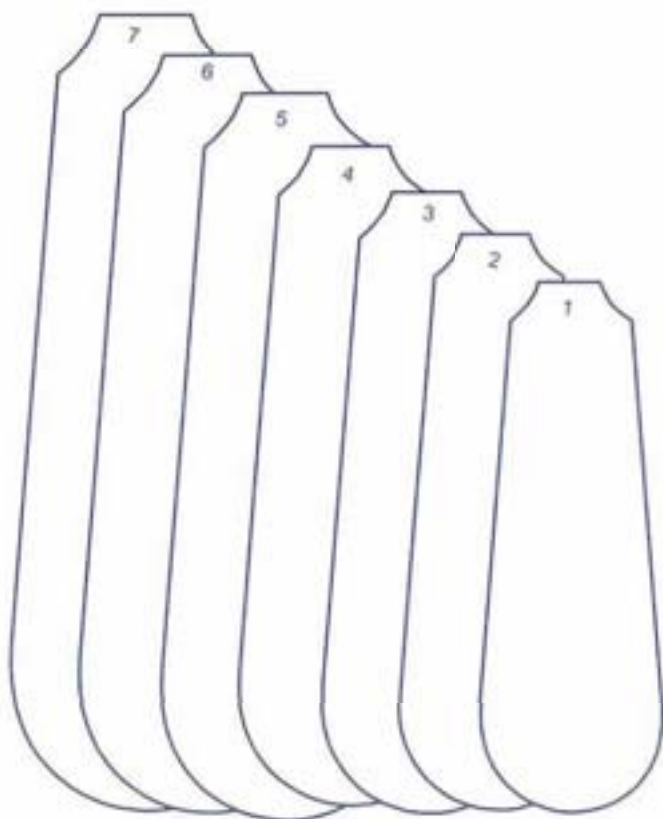
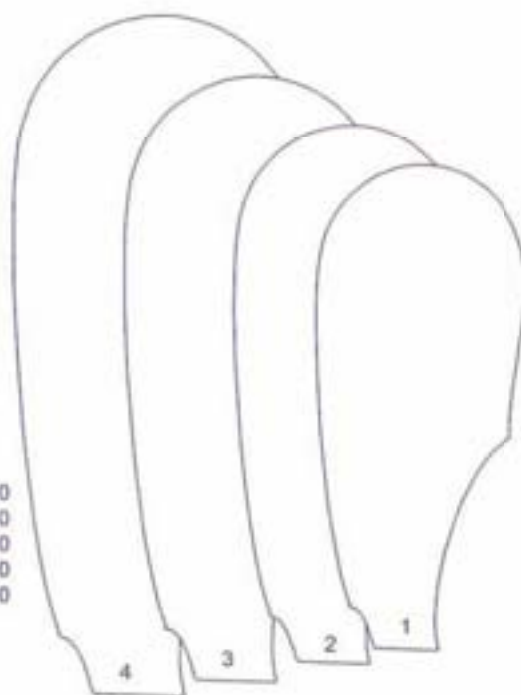

Davis-Meyer
modifiziert
modified

- Fig. 1 74-0701-00
- Fig. 2 74-0702-00
- Fig. 3 74-0703-00
- Fig. 4 74-0704-00
- Fig. 5 74-0705-00
- Fig. 6 74-0706-00
- Fig. 7 74-0707-00

Spatel Tongue blades

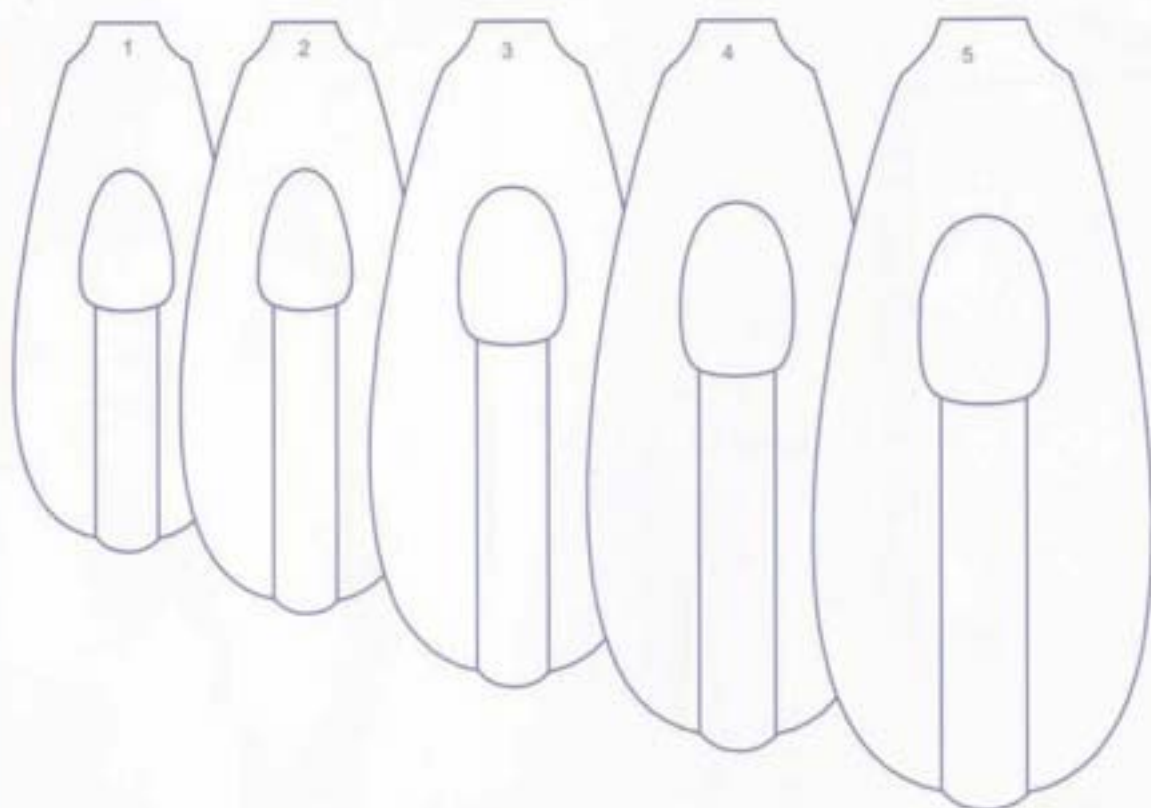

Klärer
mit Mittellinie
with groove

- Fig. 0 74-0540-00
- Fig. 1 74-0541-00
- Fig. 2 74-0542-00
- Fig. 3 74-0543-00
- Fig. 4 74-0544-00
- Fig. 5 74-0545-00



mit Mittellinie
seitlich offen
with groove
lateral slot

- Fig. 1 74-0571-00
- Fig. 2 74-0572-00
- Fig. 3 74-0573-00
- Fig. 4 74-0574-00
- Fig. 5 74-0575-00

Spatel
Tongue blades

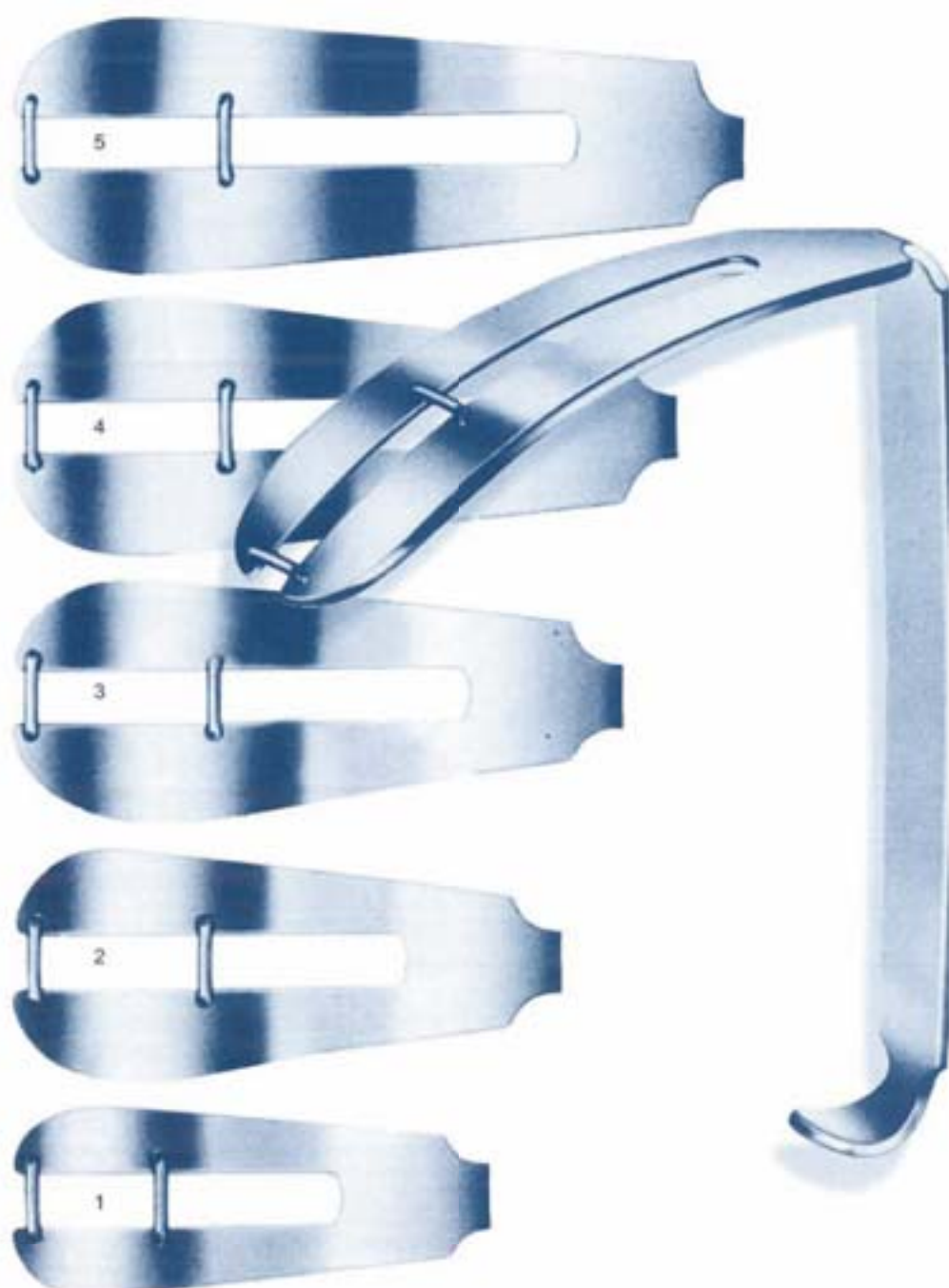

Modell Würzburg

- Fig. 1 74-0581-00
- Fig. 2 74-0582-00
- Fig. 3 74-0583-00
- Fig. 4 74-0584-00
- Fig. 5 74-0585-00

Spatel Tongue blades



Ring Spatel

tongue blades

	rechts / right	links / left
Fig. 2	74-0592-00	74-0552-00
Fig. 3	74-0593-00	74-0553-00
Fig. 4	74-0594-00	74-0554-00
Fig. 5	74-0595-00	74-0555-00

Tonsillektomie



Wilder Dilatator
dilator
12-0820-00



Knopfkannüle
button cannula
0,5 x 100 mm 12-0830-00
0,8 x 100 mm 12-0831-00



Bowman Sonde
zylindrisch
probe cylindric
00/0 12-0825-00
1/2 0,9 x 1,2 mm 12-0826-00
3/4 1,3 x 1,4 mm 12-0827-00



Seiffert Tubensonde
eustachian probe
Feinsilber
fine silver
180 x 0,5 mm 63-0382-00N



Jaentsch Sialgraphie-katheter-Set
VE = 5
sialography catheter-set
85-2794-00



Kehlkopfspritze mit drehbaren Ringen, Luer Lock
laryngeal syringe with tunable rings
2 ml 74-0453-00
5 ml 74-0454-00

Ansatzrohr für Kehlkopfspritze
laryngeal cannula

74-0455-00



Speichelgangschere
salival scissors
12 cm 15-0152-00



Perwitschky Speichelgangschere
salival scissors
10 cm 15-0095-00

Septumkanülen / septum cannulas

0,8 mm gebogen
curved
12-1170-00



0,8 mm gerade
straight
12-1171-00



0,8 mm bajonettform
bayonet-shaped
12-1172-00



0,8 mm kniegebogen
knee-shaped
12-1173-00



Tonsillektomie



Klingenhalter
scalpel handle
12-0003-00L



12-0007-00



10



11



12



15

S-M Klengen steril

S-M blades sterile

12-0010-00

12-0011-00

12-0012-00

12-0015-00

doppelschneidig
two - edged



Tonsillenmesser
tonsil knife
17 cm
68-0039-00



Brünings
22,5 cm
68-0041-00



Colver
22 cm
68-0043-00



Perwitschky
22,5 cm
68-0045-00



Chirurgische Pinzetten
surgical forceps



- a 20 cm
14-2262-00
- b 20 cm
14-0103-00
- c 20 cm
2-3 Zähne / teeth
14-0404-00
- d 20 cm
3-4 Zähne / teeth
14-0414-00

Tonsillenpinzetten
tonsil forceps

Marschik 22 cm 68-0002-00



Duehrssen 20 cm 13-0270-00



20 cm 13-0103-00



Colver
Tonsillenfäßzange
tonsillar holding forceps
19 cm
68-0016-00



Blohmke
Tonsillenfäßzange
tonsillar holding forceps
20 cm
68-0015-00

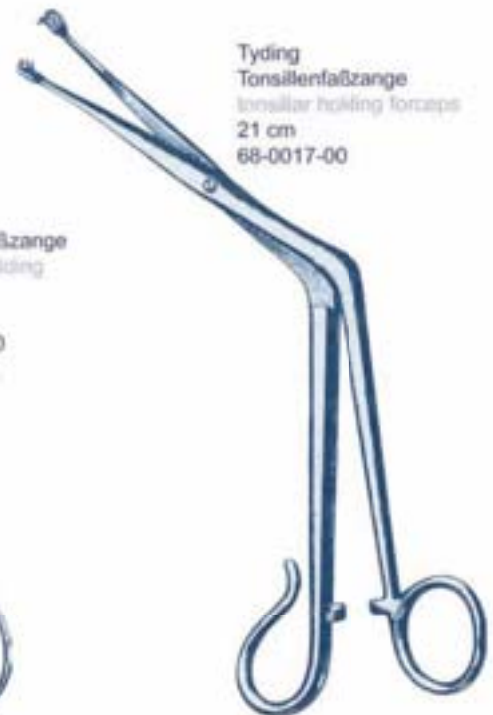

Tyding
Tonsillenfäßzange
tonsillar holding forceps
21 cm
68-0017-00

Tonsillektomie

Tonsillektomie - Sauger Tonsillectomy suction tubes



Tonsillektomie

Tonsillenscheren
Tonsillar scissors

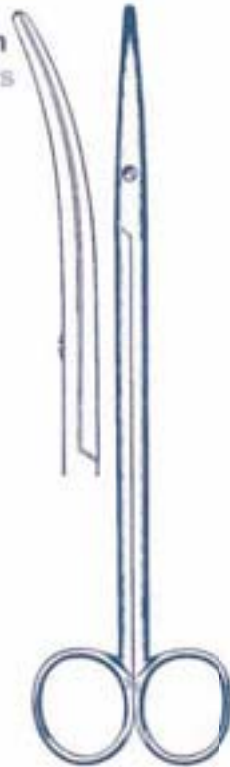

Metzenbaum gebogen
curved
18 cm 15-0201-00



Lillie gebogen
curved
21 cm 15-0244-00



Potts-Smith
abgewinkelt 25°, spitz
angled, pointed
19 cm 15-0240-00



Boettcher
18 cm 15-0245-00



Good-Schweckendieck
gezahnt / serrated
19 cm 15-0248-01



Prince
18 cm 15-0246-00



Good
19 cm 15-0248-00



Muck
18 cm 15-0242-00



Dean
18 cm 15-0249-00

Tonsillenklemmen Tonsillar forceps



Ochsen-Kocher, 20 cm
2-1 Zähne / teeth
1 gerade / straight 17-0406-00
2 gebogen / curved 17-0407-00

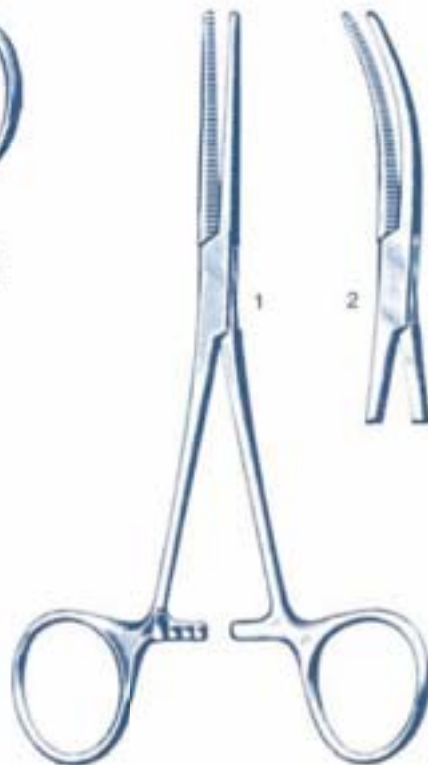

Rochester-Pean, 20 cm
1 gerade / straight 17-0306-00
2 gebogen / curved 17-0307-00

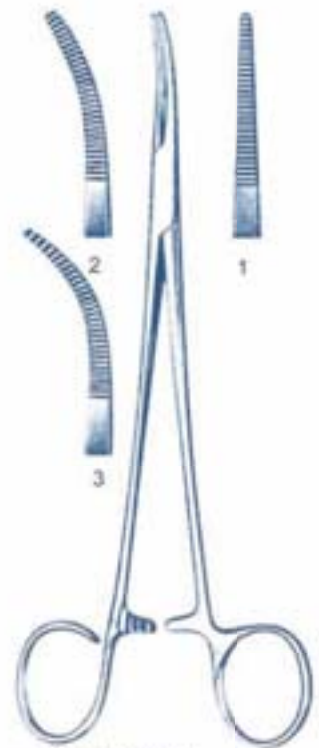

Schnitz, 19 cm
1 gerade / straight 17-0536-00
2 leicht gebogen / light curved 17-0537-00
3 stark gebogen / strong curved 17-0539-00

Tonsillenklemmen
Tonsillar forceps

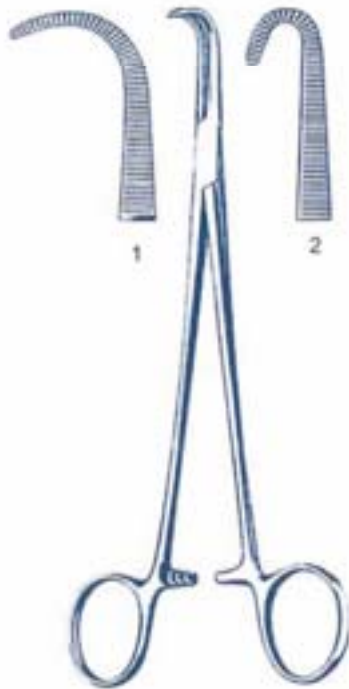

Negus
1 weit gebogen / wide curved
19 cm 17-0541-00
2 eng gebogen / narrow curved
19 cm 17-0543-00



Mikulicz
offene Ringe / open rings
18 cm 17-0635-00
20 cm 17-0636-00
geschlossene Ringe
closed rings
18 cm 17-0700-00
20 cm 17-0701-00

Mikulicz
geschlossene Ringe
closed rings
18 cm 17-0718-00
20 cm 17-0720-00



Roberts
gebogen / curved
22 cm 17-0605-00

Tonsillektomie



Sluder-Ballenger Tonsillotom

Tonsillectome	
komplett / complete	68-0320-00
Griff / handle	68-0320-13
Ansatz 1 / blade 1	68-0320-21
Ansatz 2 / blade 2	68-0320-22
Ansatz 3 / blade 3	68-0320-23



1 16 mm
2 12 mm
3 10 mm

Henke Tonsillenelevatorium tonsillar elevator

1 breit / broad	68-0026-00
2 mittel / medium	68-0025-02
3 schmal / narrow	68-0025-00



Lopez-Reinke
Saugelevatorium
suction elevator
23.5 cm 68-0035-00

Hurd Tonsillenelevatorium
tonsillar elevator
22 cm 68-0031-00

Tonsillektomie



Loch
Tonsillenelevatorium
tonsillar elevator
21 cm 68-0030-00



Henke TE-Elevatorium
tonsillar elevator
24 cm
68-0028-00



Brünings Tonsillenschnürer
28 cm mit Sperre
tonsillar snare with ratchet
68-0020-00



Eves Tonsillenschnürer
tonsillar snare
28 cm
68-0021-00

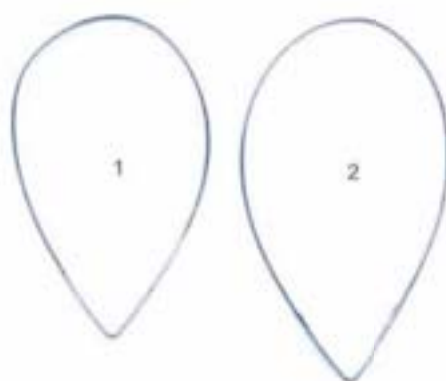

Tonsillenschlingen gelötet
tonsillar wire loops, soldered

1	0,40 x 40 mm	68-0967-40
2	0,40 x 50 mm	68-0967-50

Tonsillektomie



**Herzfeld
Gaumenhaken**
palatine hook
20 cm 68-0011-00

**mit Kerbe
with notch**
20 cm
68-0011-02

**abgewinkelt
angled**
20 cm
68-0014-00

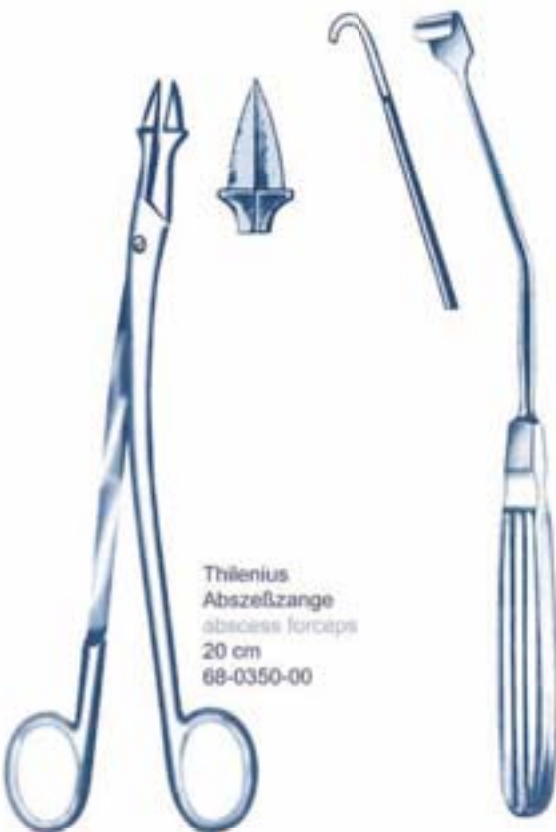

**Thilenius
Abszeßzange**
abscess forceps
20 cm
68-0350-00

**Nager
Gaumenhaken**
palatine hook
23 cm
68-0012-01



**Catgutschlingen
für Roederbinder**
catgut loops for
ligature carrier

Form E
00 12-9010-00

Form F
0 12-9011-00
1 12-9012-00

Roederbinder
ligature carrier
27 cm
Form E 68-0245-00
Form F 68-0246-00

Tonsillenkompessorium
Tonsillar compressorium



Corwin
Tonsillenkompessorium
tonsillar compressorium

150 mm
68-0206-00



Vetter
Tonsillenkompessorium
tonsillar compressorium
150 mm
für Erwachsene
for adults
68-0205-02

für Kinder
for children
68-0205-00

Umstechungsnadeln
Tonsillar suture needle



Tonsillektomie

Umstechungsnadeln / Tonsillar suture needle
 Fadengabel / Knot tyer
 Fadenhäkchen / Suture hooks

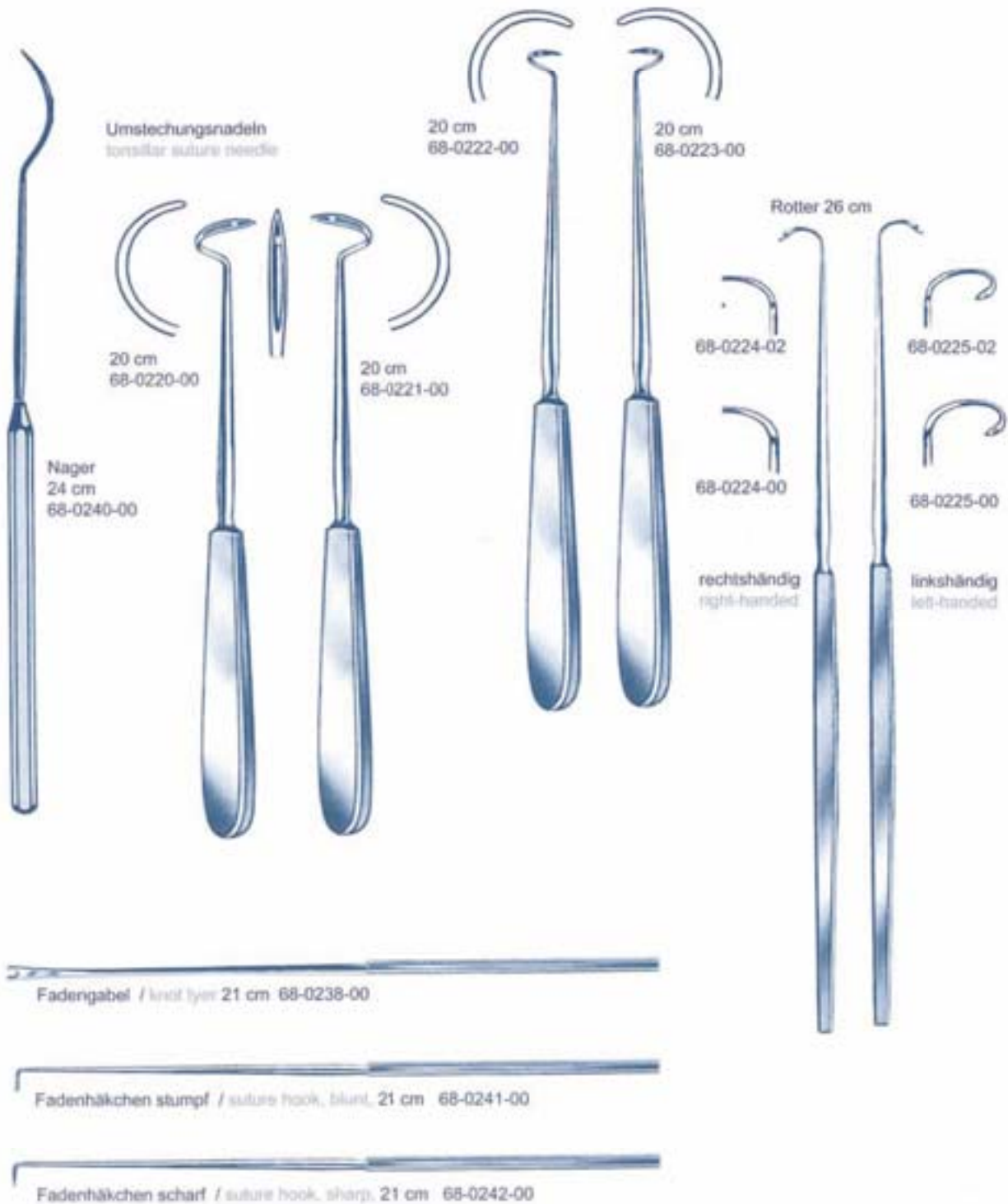



Tonsillektomie

Mikro-Laryngoskopie
Micro-Laryngoscopy





Operationslaryngoskope
Surgical laryngoscopes

	Spatellänge length of spatula	
Fig. 1	135 mm	69-0100-01
Fig. 2	152 mm	69-0100-02
Fig. 3	182 mm	69-0100-03
Fig. 4	172 mm	69-0100-04
Fig. 5	172 mm	69-0100-05
Fig. 6	182 mm	69-0100-06
Fig. 7	222 mm	69-0100-07



Fiberglas-Lichtträger für
fiberoptic light tube for

Fig. 1	69-0102-01
Fig. 2	69-0102-02
Fig. 3	69-0102-03
Fig. 4	69-0102-04
Fig. 5	69-0102-05
Fig. 6	69-0102-06
Fig. 7	69-0102-07

Injektionskanüle
Laryngoskop
injection drain cannula for
für 69-0100-03 bis -07
69-0103-07



Rauchabsaugrohr / suction tube
Laryngoskop
für 69-0100-03 bis -07
69-0104-06

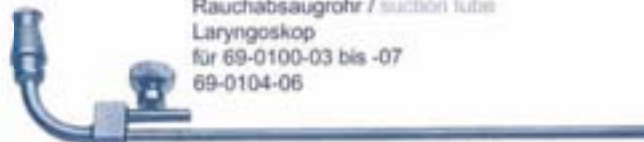



Weerda
OP-Laryngoskop, spreizbar für Erwachsene
spreadable, for adults
69-0100-00



Jackson Laryngoskop
für die obere Kommissur
for upper commissure
Fig. 1 für Säuglinge / for baby 120 mm 69-0111-01
Fig. 2 für Kinder / for child 170 mm 69-0111-02
Fig. 3 für Erwachsene / for adults 180 mm 69-0111-03



Holinger Laryngoskop
180 mm 69-0115-00



Bruststütze
chest support

Stützstange für Erwachsene
rest bar for adults
34 cm
69-0101-00

Stützstange für Kinder
rest bar for children
24 cm
69-0101-01
(o. Abb.)



Scheren Scissors









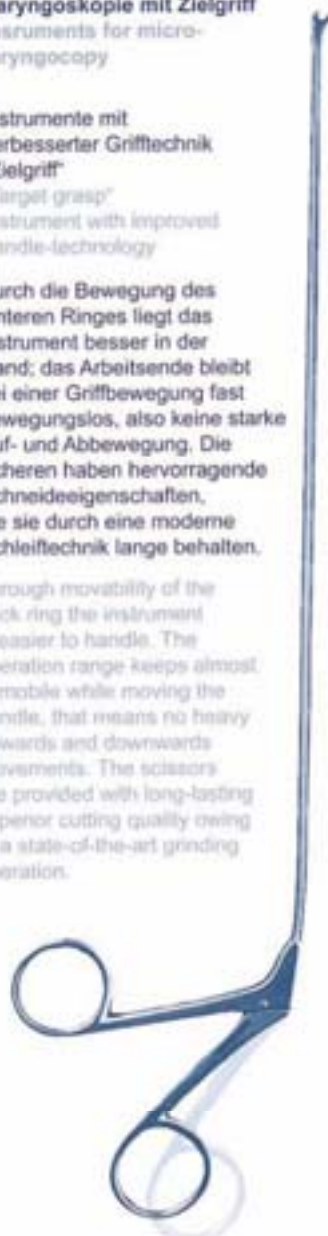



Instrumente zur Mikro-Laryngoskopie mit Zielgriff
Instruments for micro-laryngoscopy

Instrumente mit verbesserter Grifftechnik „Zielgriff“
„Target grasp“
Instrument with improved handle-technology

Durch die Bewegung des hinteren Ringes liegt das Instrument besser in der Hand; das Arbeitsende bleibt bei einer Griffbewegung fast bewegungslos, also keine starke Auf- und Abbewegung. Die Scheren haben hervorragende Schneideigenschaften, die sie durch eine moderne Schleiftechnik lange behalten.

Through movability of the back ring the instrument is easier to handle. The operation range keeps almost immobile while moving the handle, that means no heavy upwards and downwards movements. The scissors are provided with long-lasting superior cutting quality owing to a state-of-the-art grinding operation.



	Standard standard	fein fine	zart delicate
 gerade / straight	69-0210-30	69-0210-31	69-0210-32
 horizontal / horizontal	69-0211-30	69-0211-31	69-0211-32
 aufgebogen / upcurved	69-0212-30	69-0212-31	69-0212-32
 aufgebogen-horizontal / upcurved horizontal	69-0213-30	69-0213-31	69-0213-32
 rechts / right	69-0225-30	69-0225-31	69-0225-32
 links / left	69-0230-30	69-0230-31	69-0230-32
Faßzängchen forceps	Standard standard	fein fine	zart delicate
 gerade / straight	69-0720-30	69-0720-31	69-0720-32
 horizontal / horizontal	69-0721-30	69-0721-31	69-0721-32
 aufgebogen-horizontal / upcurved horizontal	69-0722-30	69-0722-31	69-0722-32
 rechts / right	69-0724-30	69-0724-31	69-0724-32
 links / left	69-0726-30	69-0726-31	69-0726-32
 gerade-oval / straight oval	69-0814-00		

Doppellöffelzangen Double cupped forceps

Instrumente zur Mikro-Laryngoskopie mit Zielgriff
Instruments for micro-laryngocopy



Instrumente mit verbesserter Grifftechnik „Zielgriff“
„Target grasp“
Instrument with improved handle-technology

Doppellöffelzange gerade, gefenestert
double cupped forceps
straight, fenestrated



69-0818-30 vertikal

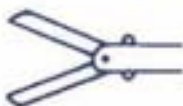

69-0819-30 horizontal

Doppellöffelzangen
double cupped forceps

Standard standard	fein fine	zart delicate
2,50 mm	2,00 mm	1,00mm



gerade / straight

69-0780-30

69-0780-31

69-0780-32



aufgebogen / angled

69-0782-30

69-0782-31

69-0782-32



aufgebogen-horizontal / angled horizontal

69-0783-30

69-0783-31

69-0783-32



rechts / right

69-0784-30

69-0784-31

69-0784-32



links / left

69-0786-30

69-0786-31

69-0786-32

Durch die Bewegung des hinteren Ringes liegt das Instrument besser in der Hand; das Arbeitende bleibt bei einer Griffbewegung fast bewegungslos, also keine starke Auf- und Abbewegung. Die Scheren haben hervorragende Schneideigenschaften, die sie durch eine moderne Schleiftechnik lange behalten.

Through movability of the back ring the instrument is easier to handle. The operation range keeps almost immobile while moving the handle, that means no heavy upwards and downwards movements. The scissors are provided with long-lasting superior cutting quality owing to a state-of-the-art grinding operation.

Micro-Laryngoskopie



**Tellermesser
gerade-oval**
sickle knife
straight-oval
250 mm
69-0820-00



Sichelmesser
sickle knife
250 mm
69-0821-00



**Tellermesser
45° abgewinkelt
oval**
disk knife
45° angled
3,0 x 1,5 mm
69-0823-00
5,5 x 3,0 mm
69-0825-00



**Tellermesser
seitlich
abgebogen**
disk knife
curved sideways
250 mm
69-0822-00



Knotenschieber
knot tyer
250 mm
69-0834-00



Handgriff
handle
(für 69-0820 - 0841)
69-0860-00



**Häkchen mit
Sondenkopf**
90° stumpf
hook with
tube button
blunt
250 mm
69-0830-00



Häkchen
hook
90° scharf
sharp
250 mm
69-0831-00



Umstechungsnadel
ligature needle
250 mm
rechts/ right
69-0840-00



links / left
69-0841-00

Zahnschutz teeth protector



Kunststoff steril
plastic, sterile
69-8700-00



Metall, Satz 3 Stück
metal, set 3 units
69-8704-00



Kunststoff mit Box, farblos
plastic, with box, colorless
69-8702-00



Watteträger
cotton applicator
250 mm NL
69-0970-00



Kanüle
0,8 x 2,5 x
270 mm
Spitze 90°
abgebogen
mit Luer-
Lock-Ansatz
cannula
tip 90° angled
with Luer-
Lock attempt
270 mm NL
69-0979-00



Kanüle
0,8 x 2,5 x
270 mm
mit Luer-
Lock-Ansatz
cannula with
Luer-Lock
attempt
gerade
straight
270 mm NL
69-0987-01

**Spitze bayonett-
förmig**
tip bayonet
shaped
270 mm NL
69-0980-00



Schnürer
snare
250 mm NL
69-8690-00



**Sauger mit
Unterbrecher**
suction cannula
with interruptor
250 mm NL
2 mm
69-8602-00
3 mm
69-8604-00



Saug- und Koagulationsrohr
Suction and Coagulation tube
260 x 4 mm 69-8605-05
260 x 2,5 mm 69-8605-04

Kabel / Cable 90-0280-04
3,5 m



Larynx-Tastelektrode
250 mm Nutzlänge
Test electrode
250 mm working
length
bipolar
90-0975-00

Kabel bipolar
Cable bipolar
3 m 90-1615-00
5 m 90-1615-05



Micro-Laryngoskopie

Tracheotomie
Tracheotomy



Faßzangen / Grasping forceps
Spreizer / Spreader



Finzen Spreizer / spreader
50 mm scharf / sharp 26-1130-00
70 mm scharf / sharp 26-1132-00

Lahey Faßzange
grasping forceps
3 : 3 Zähne / teeth
150 mm
70-0016-00

200 mm
70-0016-20



Löbker Faßzange
grasping forceps
150 mm
1:1 Zähne / teeth
70-0015-00

180 mm
1:1 Zähne / teeth
70-0018-00

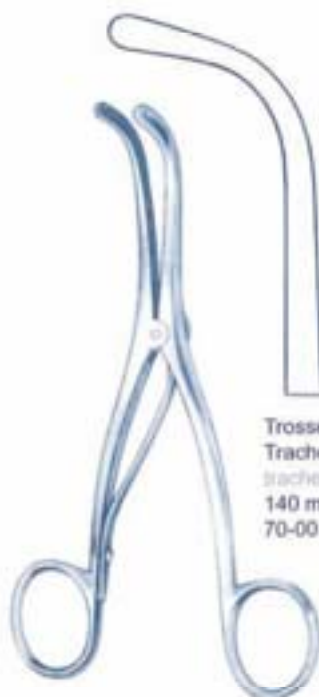
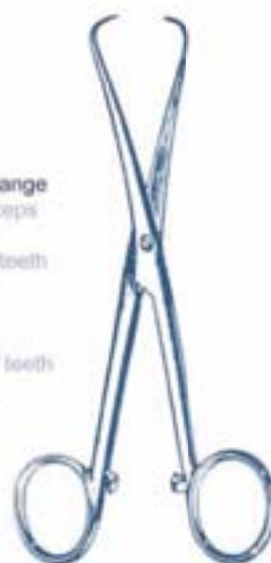

Trosseau
Tracheostomaspreizer
tracheostoma spreader
140 mm
70-0019-00

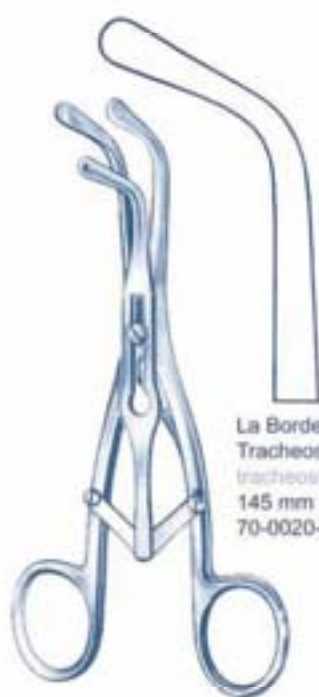

La Borde
Tracheostomaspreizer
tracheostoma spreader
145 mm
70-0020-00



Laryngofissurschere,
gezahnt
laryngofissure scissors,
toothed
220 mm
70-0200-00



Weerda
Tracheostomaspreizer
Spezialmodell
190 mm
tracheostoma spreader
special model
190 mm
71-0021-00



Wagener Intubationsrohr
biegsam
tracheostoma intubation
tube
flexible
5 mm 70-0035-00
7 mm 70-0037-00
9 mm 70-0039-00



Kilian Trachealspekulum
tracheal speculum
Fig. 4
64-0044-00

Trachealhäkchen
Trachealhooks

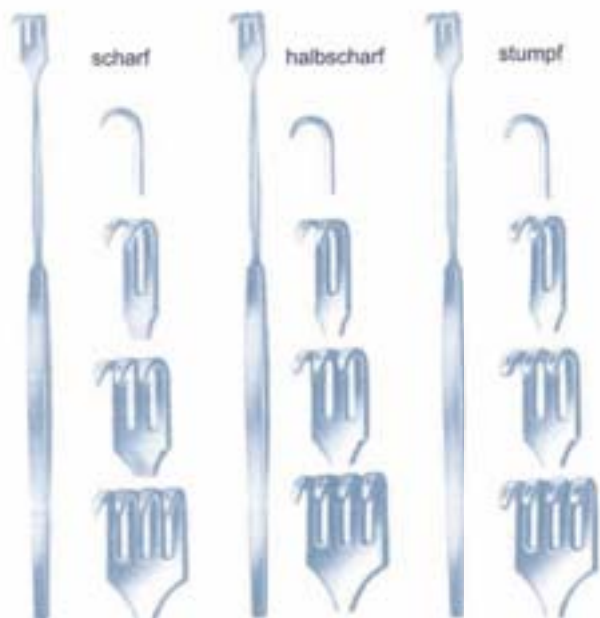

Senn-Miller Haken

Hooklet
scharf / sharp
160 mm
24-0130-00

Häkchen

Hooklet
1-zahlig / toothy
150 mm
24-0011-00

Trachealhäkchen 170 mm
tracheal hooklet

1	24-0031-00	24-0001-00	24-0021-00
2	24-0032-00	24-0002-00	24-0022-00
3	24-0033-00	24-0003-00	24-0023-00
4	24-0034-00	24-0004-00	24-0024-00

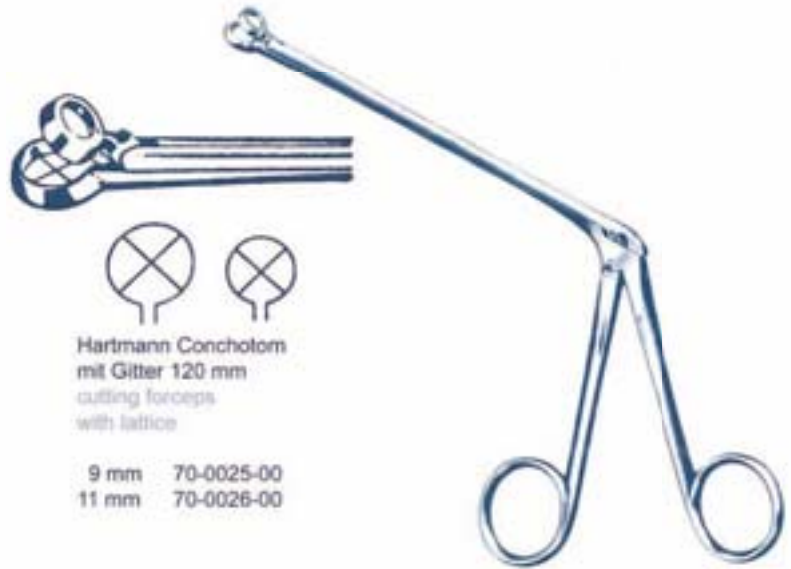

Hartmann Conchotom
mit Gitter 120 mm
cutting forceps
with lattice

9 mm 70-0025-00
11 mm 70-0026-00



Schoenborn
Schilddrüsenhaken
thyroid hook
210 x 6 mm
70-0022-00



Kocher
Führungssonde
director
160 x 12 mm
34-0421-00



Uckermann Trokar
mit Trachealkanüle
trocar w. silver cannula
7,5 mm 70-0008-00
9,0 mm 70-0010-00

Mund-Kehlkopf
Mouth-Larynx

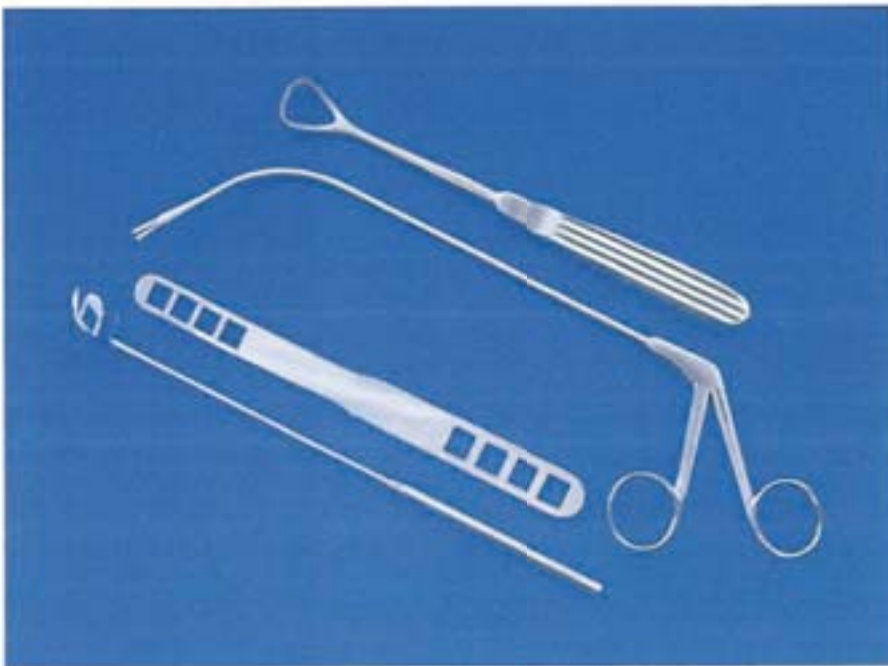

Zungenspatel

Tongue depressor



**Moritz-Schmidt
Mundspatel**
tongue
depressor
190 mm
74-0364-00

**Brünings
Mundspatel**
tongue depressor
190 mm
74-0362-00



**Tobold
Zungenspatel**
tongue depressor
145 mm
74-0367-00

**Hartmann
Zungenspatel**
tongue
depressor
165 mm
74-0366-00



**Frenzel
Zungenspatel**
tongue
depressor
165 mm
74-0360-00

**Sternberg
Lippenhalter**
check retractor
160 mm
74-0370-00

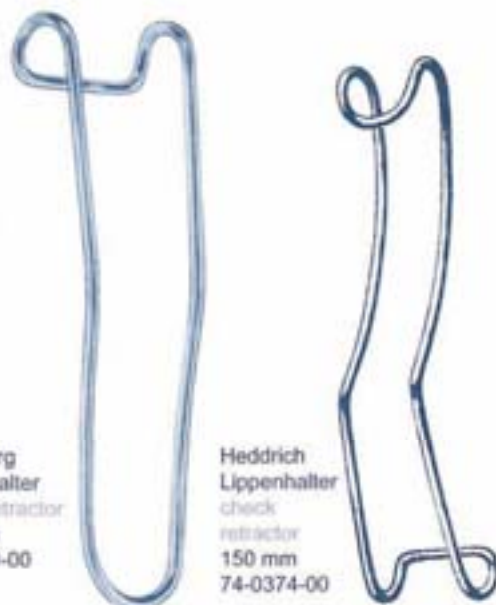

**Heddrich
Lippenhalter**
check
retractor
150 mm
74-0374-00

Spiegel Mirrors

Kehlkopfspiegel laryngeal mirrors

Größe size	Achtkantgriff Spieg. austauschbar Mirror insert interchangeable	Oesengriff long handle	ohne Griff without handle	ohne Griff mit Gewinde with thread
K 000	74-0376-00	74-0406-00	74-0428-00	74-0828-00
K 00	74-0379-00	74-0409-00	74-0429-00	74-0829-00
K 0	74-0380-00	74-0410-00	74-0430-00	74-0830-00
K 1	74-0381-00	74-0411-00	74-0431-00	74-0831-00
K 2	74-0382-00	74-0412-00	74-0432-00	74-0832-00
K 3	74-0383-00	74-0413-00	74-0433-00	74-0833-00
K 4	74-0384-00	74-0414-00	74-0434-00	74-0834-00
K 5	74-0385-00	74-0415-00	74-0435-00	74-0835-00
K 6	74-0386-00	74-0416-00	74-0436-00	74-0836-00
K 7	74-0387-00	74-0417-00	74-0437-00	74-0837-00
K 8	74-0388-00	74-0418-00	74-0438-00	74-0838-00
K 9	74-0389-00	74-0419-00	74-0439-00	74-0839-00
K 10	74-0390-00	74-0420-00	74-0440-00	74-0840-00

Ersatzgriff
spare handle
74-0392-00



Ultra-Stop
Antibeslag
anti-condensation
siehe Endoskopie
refer to endoscopy

Spiegelgriffe mirror handles



Sechskant-
Griff
hexagonal
handle
74-0442-00

runder Griff
round handle
74-0443-00

mit
Spannschraube
with drill screw
74-0444-00

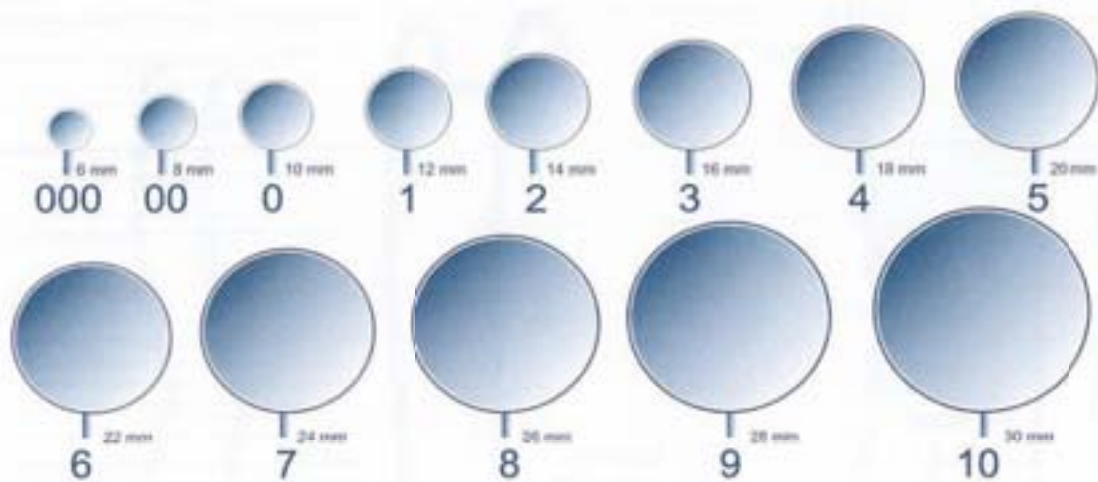

Kehlkopfszangen
Laryngeal forceps

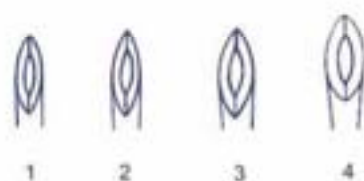

Blakesley

	gerade straight	aufgebogen curved upwards
Fig. 00	64-0401-00 H	64-0411-00 H
Fig. 0	64-0402-00 H	64-0412-00 H
Fig. 1	64-0403-00 H	64-0413-00 H
Fig. 2	64-0404-00 H	64-0414-00 H
Fig. 3	64-0405-00 H	64-0415-00 H
Fig. 4	64-0406-00 H	64-0416-00 H

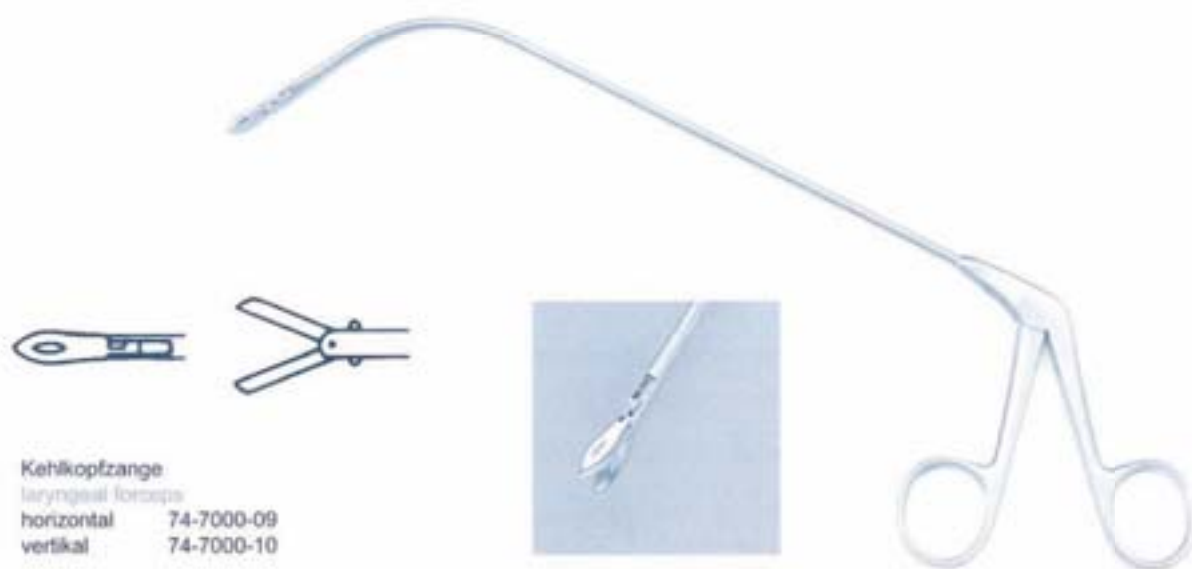

Kehlkopfszange
laryngeal forceps
horizontal 74-7000-09
vertikal 74-7000-10

Kehlkopfzangen Laryngeal forceps



Huber
Universalgriff
universal handle
74-0205-00



Brünings
Universalgriff
universal handle
74-0206-00



Kehlkopfrohre / laryngeal tubes

	gerade straight	kniegebogen knee-shaped	gebogen curved
20 cm	74-0210-20	74-0220-20	74-0250-20
25 cm	74-0210-25	74-0220-25	74-0250-25
30 cm	74-0210-30	74-0220-30	74-0250-30

Kehlkopfansätze
Laryngeal attachments



Scheinmann
45° abgewinkelt / angled
74-0309-00



Cordes
4 x 5 mm 74-0310-00
6 x 4 mm 74-0311-00



Cordes
3 x 3 mm 74-0315-00
4 x 3 mm 74-0316-00
6 x 4 mm 74-0317-00
7 x 5 mm 74-0318-00



Cordes
74-0320-00



Krause
74-0322-00



Seiffert
74-0324-00



Eicken
74-0325-00



Cordes
4 mm, rund / round
74-0326-00



Scheinmann
7 x 4 mm, 45°
abgewinkelt / angled
74-0328-00



Krause
5 x 3 mm 74-0330-00
6 x 4 mm 74-0331-00



Scheinmann
74-0332-00



Fränkel
74-0336-00



Fränkel
74-0334-00



Lange
74-0338-00



Brünings
4 x 2 mm 74-0340-00
5 x 3 mm 74-0341-00



Brünings
3 mm 74-0342-00
4 mm 74-0343-00



Baracani
74-0344-00



Eicken
beidseits öffnend
bilateral opening
74-0346-00

Pulverbläser Powder blower



Kabierske Pulverbläser
komplett mit weißem Glas
powder blower
complete with white glass
30 cc
60-0385-00



Universal - Zerstäuber
mit beweglicher Spühdüse ohne
Gebläse
universal blower
with flexible spray tip without
blower
30 ml 48-1025-00



**Reichert
Kehdeckelhalter**
epiglottis retractor
74-0450-00

Ansatzrohr für Kehkopfspritze
laryngeal cannula
74-0455-00



**Luer-Lock
Ansatz /
attachment**

**Kehkopfspritze
mit drehbaren Ringen**
laryngeal syringe
with moveable rings
2 ml 74-0453-00
5 ml 74-0454-00

Kehlkopfwatteträger
Laryngeal applicators



Kilian

74-0447-00



mit 2 Ringen, 26,5 cm
with 2 rings
74-0449-00

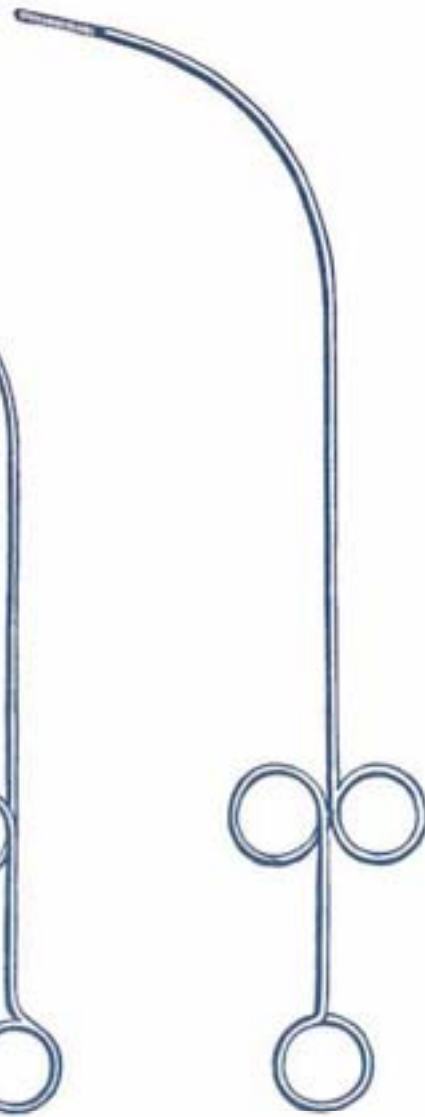

mit 3 Ringen, fein
with 3 rings, fine
74-0448-00

Gebläse / Blowers Sprayer / Sprayer

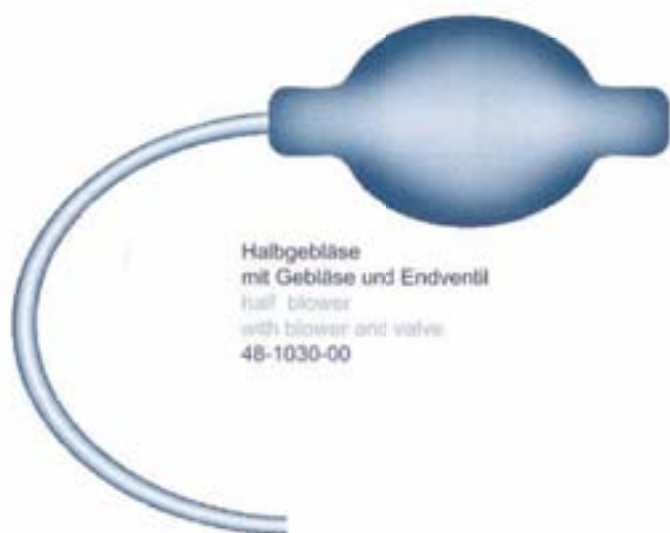

**Halbgebläse
mit Gebläse und Endventil**
half blower
with blower and valve
48-1030-00



**Zerstäuber für
Kehlkopf
ohne Gebläse, Glas
12 cm**
laryngeal sprayer
without blower, glass
12 cm
48-1013-00



**Gebläse
m. Endventil**
blower with end
valve
48-1034-00

Kiefer
Antrum



Hirn
Brain

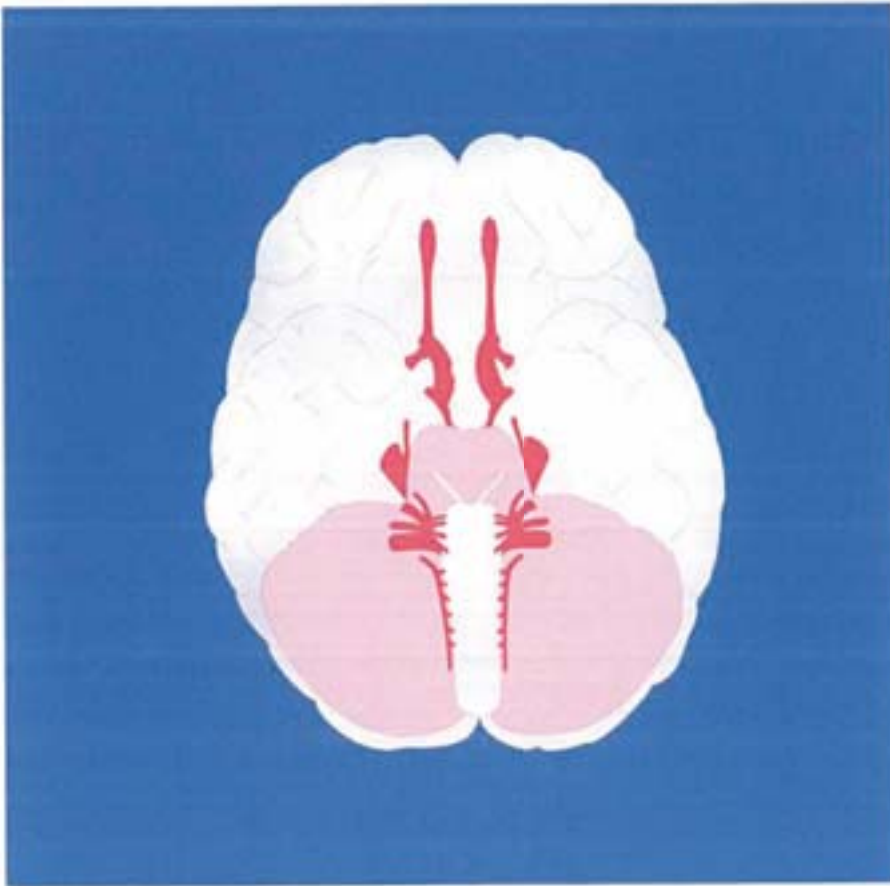

Schädelhalter / Skull holders
Giglisängen / Giglisaw
Sonde / Tube

Schädelhalter zur Halswirbelextension
 großes Modell mit verstellbaren Dornen,
 kein Vorbohren erforderlich
 Skull holder for extension the cervical vertebra,
 large model, thorns adjustable, predrilling
 not necessary
45-0050-01

Ohne Abbildung
Ersatzdorn zum Schädelhalter
 Without illustration
 Substitute thorn to the skull holder
45-0050-013



Giglisängen 4-fach, 40 cm
 Giglisaw, 4-fold, 40 cm
45-7012-00

Giglisängen 4-fach, 50 cm
 Giglisaw, 4-fold, 50 cm
45-7013-00



Griff zur Giglisäge
 Grasp to Giglisaw
45-7014-00

Bratsche Sonden / tube
 340 x 4 mm 45-7010-04
 340 x 5 mm 45-7010-05
 340 x 6 mm 45-7010-06



Schädelzangen
Skull tongs



Schädelzange nach Dahlgren 20 cm
Skull tongs acc. Dahlgren 20 cm
45-0056-20



Schädelzange nach De Vilbiss 21 cm
Skull tongs acc. De Vilbiss 21 cm
45-0056-21

Dissektoren
Dissectors



Röttgen, 230 mm
45-7001-00



Tönnis, 245 mm
45-7003-00



Kuhlendahl, 240 mm
45-7005-00



Davis, 230 mm
45-7002-00



Tönnis, 240 mm
45-7009-00

Pinzetten Forceps

Pinzetten zum Fassen von Geweben, Tumoren, bajonettförmig, mit Lochgriff
 Forceps for grasping tissue, tumors, bayonet-shaped, with hole grasp

	Artikel-Nr. Cat. No.	
Yasargil, Löffel / spoon 3 mm, 220 mm Maul löffelförmig / jaw spoon-shaped	55-0323-22	
Yasargil-Samii, Löffel / spoon 3 mm, 240 mm Maul löffelförmig / jaw spoon-shaped	55-0323-24	⊙ Ø 3 mm
Yasargil, Löffel / spoon 5 mm, 220 mm Maul löffelförmig / jaw spoon-shaped	55-0324-22	⊙
Yasargil-Samii, Löffel / spoon 5 mm, 240 mm Maul löffelförmig / jaw spoon-shaped	55-0324-24	⊙ Ø 5 mm
Yasargil-Samii, Löffel / spoon 7 mm, 240 mm Maul löffelförmig / jaw spoon-shaped	55-0325-24	⊙ Ø 7 mm
Yasargil, Löffel / spoon 3 mm, 220 mm Maul flach gezahnt / flat jaw-serrated	55-0326-22	⊙ Ø 3 mm
Yasargil, Löffel / spoon 5 mm, 220 mm Maul flach gezahnt / flat jaw-toothed	55-0327-22	⊙ Ø 5 mm
Heifetz, Löffel / spoon 3 mm, 220 mm Maul kürettenförmig / Curette shaped	55-0328-22	⊙ Ø 3 mm
Heifetz, Löffel / spoon 5 mm, 220 mm Maul kürettenförmig / Curette shaped	55-0329-22	⊙ Ø 5 mm



1/1

Pinzetten
Forceps

Pinzetten zum Fassen von Geweben, Tumoren, bajonettförmig, Maul löffelförmig
Forceps for grasping tissue, tumors, bayonet-shaped, jaw spoon-shaped

	Artikel-Nr. Cat. No.
Samii, vorwärts gebogen, 230 mm, 3 mm forward curved	55-0331-23
Samii, rückwärts gebogen, 230 mm, 3 mm backwards curved	55-0332-23
Samii, vorwärts gebogen, 230 mm, 4 mm forward curved	55-0333-23
Samii, rückwärts gebogen, 230 mm, 4 mm backwards curved	55-0334-23
Samii, vorwärts gebogen, 230 mm, 5 mm forward curved	55-0335-23
Samii, rückwärts gebogen, 230 mm, 5 mm backwards curved	55-0336-23

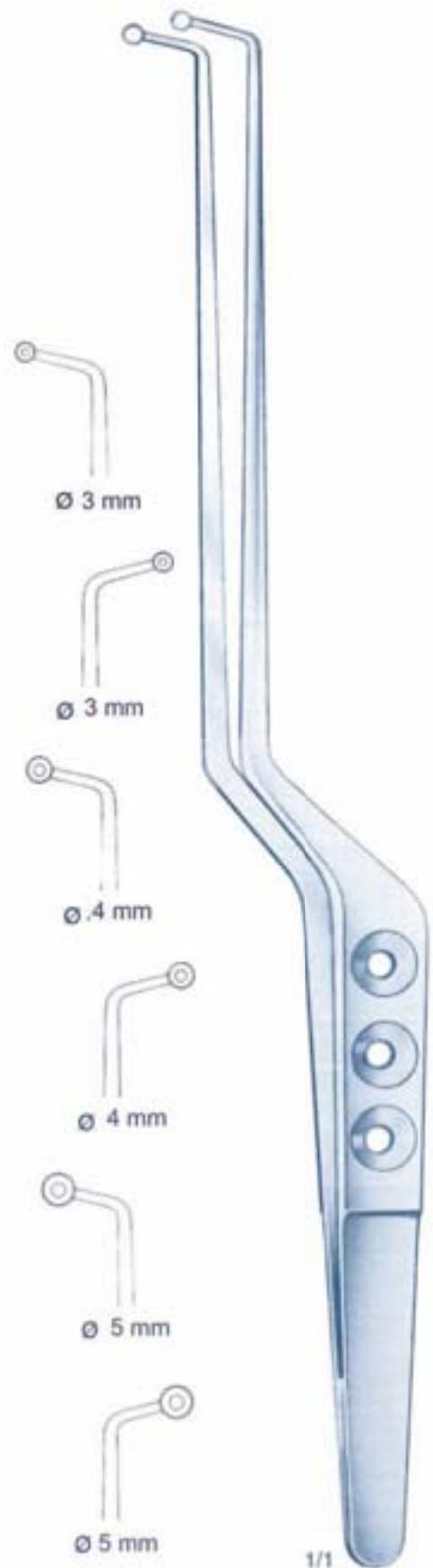

Pinzetten Forceps

Mikro-Pinzetten, bajonettförmig, mit Lochgriff Micro Forceps, bajonet-shaped, with hole grasp

	Länge Length	Artikel-Nr. Cat. No.
Yasargil, Spitze 0,6 mm Tips 0,6 mm	160 mm	55-0364-16
	180 mm	55-0364-18
	200 mm	55-0364-20
	220 mm	55-0364-22
	240 mm	55-0364-24
Yasargil, Spitze 0,9 mm Tips 0,9 mm	160 mm	55-0366-16
	180 mm	55-0366-18
	200 mm	55-0366-20
	220 mm	55-0366-22
	240 mm	55-0366-24
Yasargil, 1:2 Zähne 1:2 teeth	180 mm	55-0368-18



Mikro-Federscheren
Micro Scissors

Mikro-Federscheren, mit Lochgriff

Micro Scissors / Spring Type, with hole grasp

	Länge Length	Artikel-Nr. Cat. No.
gerade / straight	120 mm	55-0370-12
gerade / straight	160 mm	55-0370-16
Millesi, gerade, gezahnt straight, toothed blades	160 mm	55-0370-16 Z
Yasargil, gerade / straight	185 mm	55-0370-19
gebogen / curved	120 mm	55-0371-12
gebogen / curved	160 mm	55-0371-16
Millesi, gebogen, gezahnt curved, toothed blades	160 mm	55-0371-16 Z
Jacobson, gebogen / curved	185 mm	55-0371-19
Vannas, gerade / straight	120 mm 160 mm	55-0372-12 55-0372-16
Vannas, gebogen / curved	120 mm 160 mm	55-0373-12 55-0373-16
Biemer Venenschere Biemer Vein Scissors	120 mm	55-0375-13
Vannas, abgewinkelt / down angled	120 mm	55-0376-12
Potts-Yasargil, abgebogen / down curved	185 mm	55-0377-19

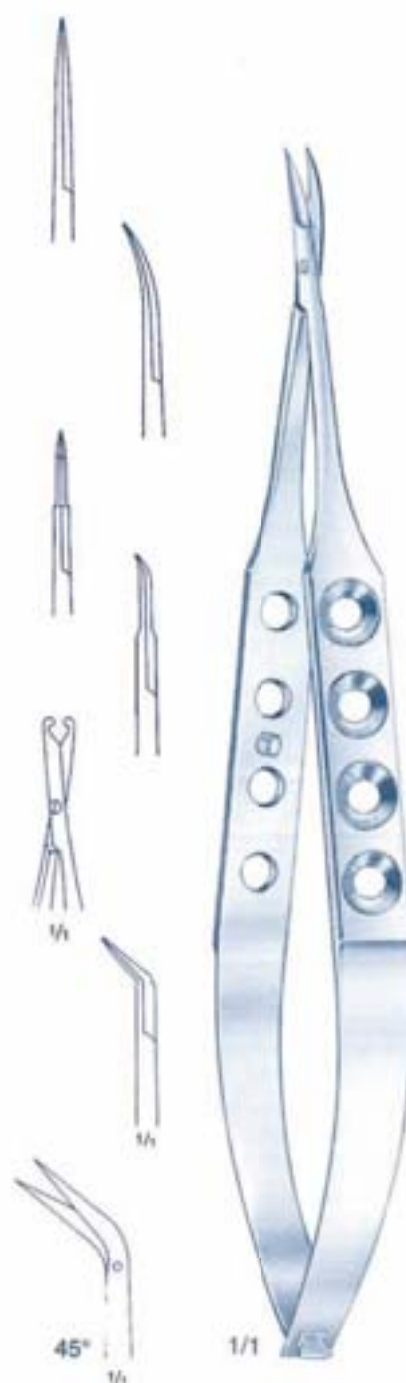

Mikro-Federscheren Micro Scissors

Mikro-Federscheren, bajonettförmig, mit Lochgriff Micro Scissors / Spring Type, bajonet-shaped, with hole grasp

	Länge Length	Artikel-Nr. Cat. No.
Vannas	225 mm	55-0380-23
	225 mm	55-0381-23
Yasargil	165 mm	55-0382-17
	200 mm	55-0382-20
	225 mm	55-0382-23
	225 mm	55-0382-23 Z
vorwärts gebogen forward curved	165 mm	55-0383-17
	200 mm	55-0383-20
	225 mm	55-0383-23
	245 mm	55-0383-25
rückwärts gebogen backwards curved	200 mm	55-0384-20
	225 mm	55-0384-23
Mikro- Präparierschere Dissecting Scissors		
Yasargil gerade straight	200 mm	55-0385-20
	225 mm	55-0385-23
Yasargil gebogen curved	200 mm	55-0386-20
	225 mm	55-0386-23

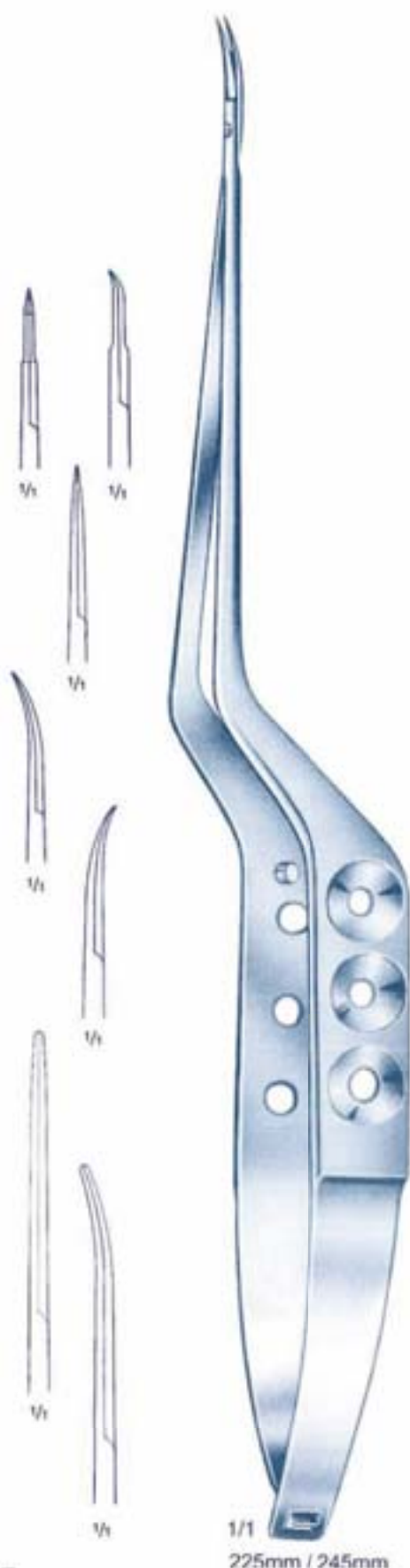

Mikro-Nadelhalter
Micro Needle Holders

Mikro-Nadelhalter mit Lochgriff, ohne Sperre
Micro Needle Holder with hole grasp, without ratchet

	Länge Length	Artikel-Nr. Cat. No.
gerade straight	160 mm 185 mm	55-0398-16 55-0398-19



Mikro-Nadelhalter mit Lochgriff, ohne Sperre
Micro Needle Holder with hole grasp, without ratchet

gebogen curved	160 mm 185 mm	55-0399-16 55-0399-19
-------------------	------------------	--------------------------



1/1



Mikro-Knüpfpinzetten Micro Knotting Forceps

	Länge Length	Artikel-Nr. Cat. No.
gerade / straight Spitzen / Tips 0,3 mm	120 mm	55-0010-12
	150 mm	55-0010-15
gerade / straight Spitzen / Tips 0,6 mm	180 mm	55-0012-18
	230 mm	55-0012-23
gebogen / curved Spitzen / Tips 0,3 mm	120 mm	55-0015-12
	150 mm	55-0015-15
gebogen / curved Spitzen / Tips 0,6 mm	180 mm	55-0017-18



Mikro-Pinzetten Micro Tying Forceps

Mikro-Pinzetten, TITAN Micro Tying Forceps, TITANIUM

	Länge Length	Artikel-Nr. Cat. No.
gerade / straight Spitze / Tips 0,4 mm	150 mm	55-1010-15 T
	180 mm	55-1010-18 T
	210 mm	55-1010-21 T
gerade / straight Spitze / Tips 0,8 mm	150 mm	55-1012-15 T
	180 mm	55-1012-18 T
	210 mm	55-1012-21 T
gebogen / curved Spitze / Tips 0,4 mm	150 mm	55-1011-15 T
	180 mm	55-1011-18 T
	210 mm	55-1011-21 T
gebogen / curved Spitze / Tips 0,8 mm	150 mm	55-1013-15 T
	180 mm	55-1013-18 T
	210 mm	55-1013-21 T



Mikro-Federscheren
Micro Scissors / Spring Type

Mikro-Federscheren mit Rundgriff
Micro Scissors / Spring Type with round grasp

	Länge Length	Artikel-Nr. Cat. No
gebogen / curved	145 mm	55-0019-15
	180 mm	55-0019-18
gerade / straight	145 mm	55-0020-15
	180 mm	55-0020-18
gebogen, fein / curved, fine	145 mm	55-0021-15
	180 mm	55-0021-18
gerade, fein / straight, fine	230 mm	55-0022-23



1/1



1/1



1/1



1/1



1/1

Mikro-Nadelhalter

Micro-Needle Holders

Mikro-Nadelhalter mit Rundgriff ohne Sperre

Micro-Needle Holders, without ratchet, with round grasp

	Länge Length	Artikel-Nr. Cat. No.
Barraquer, gerade, ohne Sperre straight, without ratchet	120 mm	55-0028-12
Reill, gerade, ohne Sperre straight, without ratchet	150 mm	55-0028-15
	185 mm	55-0028-19
Barraquer, gebogen, ohne Sperre curved, without ratchet	120 mm	55-0029-12
Reill, gebogen, ohne Sperre curved, without ratchet	150 mm	55-0032-15
	185 mm	55-0032-19



1/1



1/1



1/1



1/1



Mikro-Nadelhalter
Micro-Needle Holders

Mikro-Nadelhalter mit Rundgriff mit Sperre
Micro-Needle Holders, with ratchet

	Länge Length	Artikel-Nr. Cat. No.	
Barraquer, gerade / straight	120 mm	55-0030-12	 1/1
	150 mm	55-0030-15	
	185 mm	55-0030-19	
Barraquer, gebogen / straight	120 mm	55-0031-12	 1/1
Reill, gerade / straight	150 mm	55-0033-15	 1/1
	185 mm	55-0033-19	



Mikro-Nadelhalter
 Micro-Needle Holders

Mikro-Nadelhalter mit Rundgriff ohne Sperre, TITAN

Micro-Needle Holders with round grasp without ratchet

	Länge Length	Artikel-Nr. Cat. No.
gerade / straight	150 mm	55-1002-15 T
	180 mm	55-1002-18 T
	210 mm	55-1002-21 T

 $\frac{1}{1}$

gebogen / curved	150 mm	55-1003-15 T
	180 mm	55-1003-18 T
	210 mm	55-1003-21 T

 $\frac{1}{1}$
Mikro-Nadelhalter mit Rundgriff mit Sperre, TITAN

Micro-Needle Holders, with ratchet, TITANIUM

gerade / straight	150 mm	55-1000-15 T
	180 mm	55-1000-18 T
	210 mm	55-1000-21 T

 $\frac{1}{1}$

gebogen / curved	150 mm	55-1001-15 T
	180 mm	55-1001-18 T
	210 mm	55-1001-21 T

 $\frac{1}{1}$

1/1

Mikro Pinzetten
 Micro-Forceps

Atraumatische Mikro Pinzetten, gerade DE BAKEY, TITAN
 Atraumatic Micro-Forceps, straight DE BAKEY, TITANIUM

	Länge Length	Artikel-Nr. Cat. No.
gerade / straight		
Spitzen / Tips 1,2 mm,	150 mm	55-1020-15 T
Spitzen / Tips 1,2 mm,	180 mm	55-1020-18 T
Spitzen / Tips 1,2 mm,	210 mm	55-1020-21 T
abgewinkelt / down angled		
Spitzen / Tips 1,2 mm,	150 mm	55-1021-15 T
Spitzen / Tips 1,2 mm,	180 mm	55-1021-18 T
Spitzen / Tips 1,2 mm,	210 mm	55-1021-21 T
gerade / straight		
Spitzen / Tips 1,8 mm,	150 mm	55-1022-15 T
Spitzen / Tips 1,8 mm,	180 mm	55-1022-18 T
Spitzen / Tips 1,8 mm,	210 mm	55-1022-21 T
abgewinkelt / down angled		
Spitzen / Tips 1,8 mm,	150 mm	55-1023-15 T
Spitzen / Tips 1,8 mm,	180 mm	55-1023-18 T
Spitzen / Tips 1,8 mm,	210 mm	55-1023-21 T



1/1



Ringpinzetten
 Ring-Forceps

Mikro-Ringpinzetten, TITAN
 Micro-Ring-Forceps, TITANIUM

	Länge Length	Artikel-Nr. Cat. No.	
Ringe gerieft / Rings serrated 1 mm, gerade / straight	150 mm	55-1030-15 T	 Ø 1 mm
	180 mm	55-1030-18 T	
	210 mm	55-1030-21 T	
Ringe diamantbeschichtet / Rings diamond dust coated 1 mm, gerade / straight	150 mm	55-1032-15 T	 Ø 1 mm
	180 mm	55-1032-18 T	
	210 mm	55-1032-21 T	
Ringe gerieft / Rings serrated 2 mm, gerade / straight	150 mm	55-1034-15 T	 Ø 2 mm
	180 mm	55-1034-18 T	
	210 mm	55-1034-21 T	
Ringe diamantbeschichtet / Rings diamond dust coated 2 mm, gerade / straight	150 mm	55-1036-15 T	 Ø 2 mm
	180 mm	55-1036-18 T	
	210 mm	55-1036-21 T	



1/1



Komplettes Clip-Programm Standard und Mini
Complete Clips-Program Standard and Mini

in TITAN/TITANIUM

in hochwertigem Implantatstahl, antimagnetisch
in high quality Implant-Steel, antimagnetic

Mini-Gefäßclips nach Yasargil
Mini-Clips acc. Yasargil



55-0002-01 Y

Standard-Gefäßclips nach Yasargil
Standard-Clips acc. Yasargil



55-0002-02 Y

Pyramidenförmiges Maulprofil
Rounded pyramid pattern



Jeder Clip mit individueller Identifikations-Nummer
Each Clip with identification by serial number

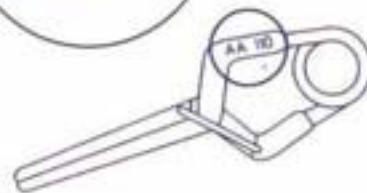

Führungsbügel
Leadership handle

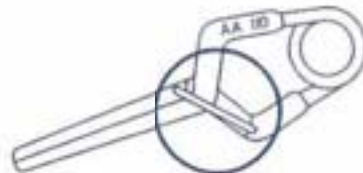

Flachfeder
Spring

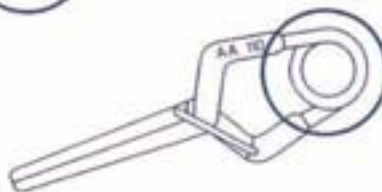















Aneurysmen-Clips für permanenten Verschluss
 Aneurysm-Clip for permanent closure

Standard

ST: TITAN/TITANIUM

S: Implantatstahl/Implant-Steel

Öffnung max. opening	Druck Force	Artikel-Nummer Cat. No.		
6,2 mm 6,2 mm	150 gms 150 gms	55-0003-01 ST 55-0003-01 S		
7,0 mm 7,0 mm	180 gms 180 gms	55-0003-02 ST 55-0003-02 S		
7,8 mm 7,8 mm	180 gms 180 gms	55-0003-03 ST 55-0003-03 S		
9,2 mm 9,2 mm	200 gms 200 gms	55-0003-04 ST 55-0003-04 S		
10,6 mm 10,6 mm	200 gms 200 gms	55-0003-05 ST 55-0003-05 S		
11,4 mm 11,4 mm	200 gms 200 gms	55-0003-06 ST 55-0003-06 S		
13,3 mm 13,3 mm	200 gms 200 gms	55-0003-07 ST 55-0003-07 S		
6,0 mm 6,0 mm	150 gms 150 gms	55-0003-08 ST 55-0003-08 S		
6,8 mm 6,8 mm	180 gms 180 gms	55-0003-09 ST 55-0003-09 S		
7,5 mm 7,5 mm	180 gms 180 gms	55-0003-10 ST 55-0003-10 S		

Aneurysmen-Clips für permanenten Verschluss
 Aneurysm-Clip for permanent closure

Standard

*ST: TITAN/TITANIUM

*S: Implantatstahl/Implanti-Steel

Öffnung max. opening	Druck Force	Artikel-Nummer Cat. No.		
8,7 mm 8,7 mm	200 gms 200 gms	55-0003-11 ST 55-0003-11 S		
5,5 mm 5,5 mm	150 gms 150 gms	55-0003-12 ST 55-0003-12 S		
6,1 mm 6,1 mm	180 gms 180 gms	55-0003-13 ST 55-0003-13 S		
6,5 mm 6,5 mm	180 gms 180 gms	55-0003-14 ST 55-0003-14 S		
7,4 mm 7,4 mm	200 gms 200 gms	55-0003-15 ST 55-0003-15 S		
5,4 mm 5,4 mm	180 gms 180 gms	55-0003-16 ST 55-0003-16 S		
5,8 mm 5,8 mm	180 gms 180 gms	55-0003-17 ST 55-0003-17 S		
6,2 mm 6,2 mm	180 gms 180 gms	55-0003-18 ST 55-0003-18 S		
7,9 mm 7,9 mm	200 gms 200 gms	55-0003-19 ST 55-0003-19 S		
8,7 mm 8,7 mm	200 gms 200 gms	55-0003-20 ST 55-0003-20 S		

Aneurysmen-Clips für temporären Verschluss
 Aneurysm-Clip for temporary closure

Standard

*ST: TITAN/TITANIUM

*S: Implantatstahl/implant-Steel

Öffnung max. opening	Druck Force	Artikel-Nummer Cat. No.
6,2 mm 6,2 mm	110 gms 110 gms	55-0003-21 ST 55-0003-21 S
7,0 mm 7,0 mm	90 gms 90 gms	55-0003-22 ST 55-0003-22 S
7,8 mm 7,8 mm	90 gms 90 gms	55-0003-23 ST 55-0003-23 S
9,2 mm 9,2 mm	90 gms 90 gms	55-0003-24 ST 55-0003-24 S
10,6 mm 10,6 mm	90 gms 90 gms	55-0003-25 ST 55-0003-25 S
11,4 mm 11,4 mm	110 gms 110 gms	55-0003-26 ST 55-0003-26 S
13,3 mm 13,3 mm	110 gms 110 gms	55-0003-27 ST 55-0003-27 S
6,0 mm 6,0 mm	110 gms 110 gms	55-0003-28 ST 55-0003-28 S
6,8 mm 6,8 mm	90 gms 90 gms	55-0003-29 ST 55-0003-29 S
7,5 mm 7,5 mm	90 gms 90 gms	55-0003-30 ST 55-0003-30 S



Aneurysmen-Clips für temporären Verschluss Aneurysm-Clip for temporary closure

Standard

ST: TITAN/TITANIUM

S: Implantatstahl/implant-Steel

Öffnung max. opening	Druck Force	Artikel-Nummer Cat. No.
8,7 mm 8,7 mm	110 gms 110 gms	55-0003-31 ST 55-0003-31 S
5,5 mm 5,5 mm	110 gms 110 gms	55-0003-32 ST 55-0003-32 S
6,1 mm 6,1 mm	110 gms 110 gms	55-0003-33 ST 55-0003-33 S
6,5 mm 6,5 mm	110 gms 110 gms	55-0003-34 ST 55-0003-34 S
7,4 mm 7,4 mm	110 gms 110 gms	55-0003-35 ST 55-0003-35 S
5,4 mm 5,4 mm	110 gms 110 gms	55-0003-36 ST 55-0003-36 S
5,8 mm 5,8 mm	110 gms 110 gms	55-0003-37 ST 55-0003-37 S
6,2 mm 6,2 mm	110 gms 110 gms	55-0003-38 ST 55-0003-38 S
7,9 mm 7,9 mm	90 gms 90 gms	55-0003-39 ST 55-0003-39 S
8,7 mm 8,7 mm	90 gms 90 gms	55-0003-40 ST 55-0003-40 S



Aneurysmen-Clips für permanenten Verschuß
Aneurysm-Clip for permanent closure

Standard

ST: TITAN/TITANIUM

S: Implantatstahl/implant-Steel

Öffnung max. opening	Druck Force	Artikel-Nummer Cat. No.
10,2 mm 10,2 mm	200 gms 200 gms	55-0003-41 ST 55-0003-41 S
11,9 mm 11,9 mm	180 gms 180 gms	55-0003-42 ST 55-0003-42 S
13,0 mm 13,0 mm	180 gms 180 gms	55-0003-43 ST 55-0003-43 S
6,2 mm 6,2 mm	200 gms 200 gms	55-0003-44 ST 55-0003-44 S
6,5 mm 6,5 mm	200 gms 200 gms	55-0003-45 ST 55-0003-45 S
7,8 mm 7,8 mm	200 gms 200 gms	55-0003-46 ST 55-0003-46 S
8,4 mm 8,4 mm	200 gms 200 gms	55-0003-47 ST 55-0003-47 S
5,6 mm 5,6 mm	200 gms 200 gms	55-0003-48 ST 55-0003-48 S
5,6 mm 5,6 mm	200 gms 200 gms	55-0003-49 ST 55-0003-49 S



Aneurysmen-Clips für permanenten Verschluss
Aneurysm-Clip for permanent closure

Standard

ST: TITAN/TITANIUM

S: Implantatstahl/Implant-Steel

Öffnung max. opening	Druck Force	Artikel-Nummer Cat. No.	
5,6 mm 5,6 mm	200 gms 200 gms	55-0003-50 ST 55-0003-50 S	
5,4 mm 5,4 mm	200 gms 200 gms	55-0003-51 ST 55-0003-51 S	
5,6 mm 5,6 mm	200 gms 200 gms	55-0003-52 ST 55-0003-52 S	
7,2 mm 7,2 mm	200 gms 200 gms 5	55-0003-53 ST 55-0003-53 S	
7,2 mm 7,2 mm	200 gms 200 gms	55-0003-54 ST 55-0003-54 S	
8,2 mm 8,2 mm	200 gms 200 gms	55-0003-55 ST 55-0003-55 S	
5,7 mm 5,7 mm	200 gms 5 200 gms	55-0003-56 ST 55-0003-56 S	
8,0 mm 8,0 mm	200 gms 200 gms	55-0003-57 ST 55-0003-57 S	
7,0 mm 7,0 mm	200 gms 200 gms	55-0003-58 ST 55-0003-58 S	

Aneurysmen-Clips für temporären Verschluss
Aneurysm-Clip for temporary closure

Standard

ST: TITAN/TITANIUM

S: Implantatstahl/implant-Steel

Öffnung max. opening	Druck Force	Artikel-Nummer Cat. No.
5,6 mm	130 gms	55-0003-68 ST
5,6 mm	130 gms	55-0003-68 S
5,4 mm	130 gms	55-0003-69 ST
5,4 mm	130 gms	55-0003-69 S
5,6 mm	130 gms	55-0003-70 ST
5,6 mm	130 gms	55-0003-70 S
7,2 mm	90 gms	55-0003-71 ST
7,2 mm	90 gms	55-0003-71 S
7,2 mm	90 gms	55-0003-72 ST
7,2 mm	90 gms	55-0003-72 S
8,2 mm	90 gms	55-0003-73 ST
8,2 mm	90 gms	55-0003-73 S
5,7 mm	90 gms	55-0003-74 ST
5,7 mm	90 gms	55-0003-74 S
8,0 mm	90 gms	55-0003-75 ST
8,0 mm	90 gms	55-0003-75 S
7,0 mm	90 gms	55-0003-76 ST
7,0 mm	90 gms	55-0003-76 S

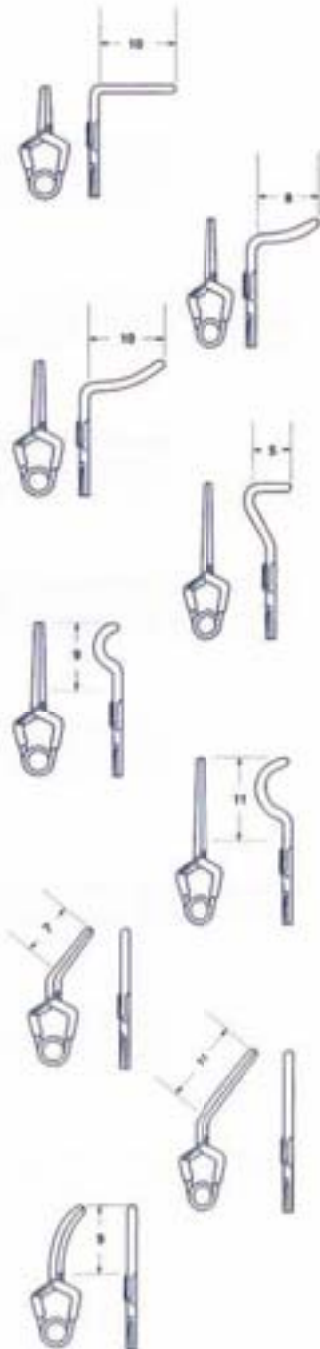

Aneurysmen-Clips für permanenten Verschuß, gefenestert, 3,5 mm **Standard**
 Aneurysm-Clip for permanent closure, fenestrated, 3.5 mm

"ST": TITAN/TITANIUM

"S": Implantatstahl/implant-Steel

Öffnung max. opening	Druck Force	Artikel-Nummer Cat. No.
7,4 mm 7,4 mm	150 gms 150 gms	55-0003-77 ST 55-0003-77 S
8,4 mm 8,4 mm	150 gms 150 gms	55-0003-78 ST 55-0003-78 S
9,6 mm 9,6 mm	180 gms 180 gms	55-0003-79 ST 55-0003-79 S
5,8 mm 5,8 mm	150 gms 150 gms	55-0003-80 ST 55-0003-80 S
6,5 mm 6,5 mm	150 gms 150 gms	55-0003-81 ST 55-0003-81 S
7,2 mm 7,2 mm	180 gms 180 gms	55-0003-82 ST 55-0003-82 S
4,9 mm 4,9 mm	150 gms 150 gms	55-0003-83 ST 55-0003-83 S
4,9 mm 4,9 mm	150 gms 150 gms	55-0003-84 ST 55-0003-84 S
4,9 mm 4,9 mm	180 gms 180 gms	55-0003-85 ST 55-0003-85 S

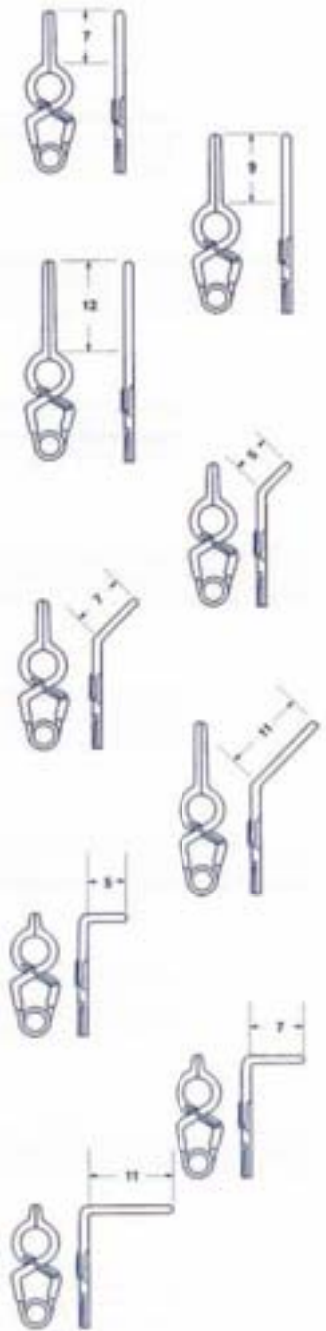

Aneurysmen-Clips für temporären Verschuß, gefenestert, 3,5 mm **Standard**
 Aneurysm-Clip for temporary closure, fenestrated, 3,5 mm

ST: TITAN/TITANIUM

S: Implantatstahl/Implant-Steel



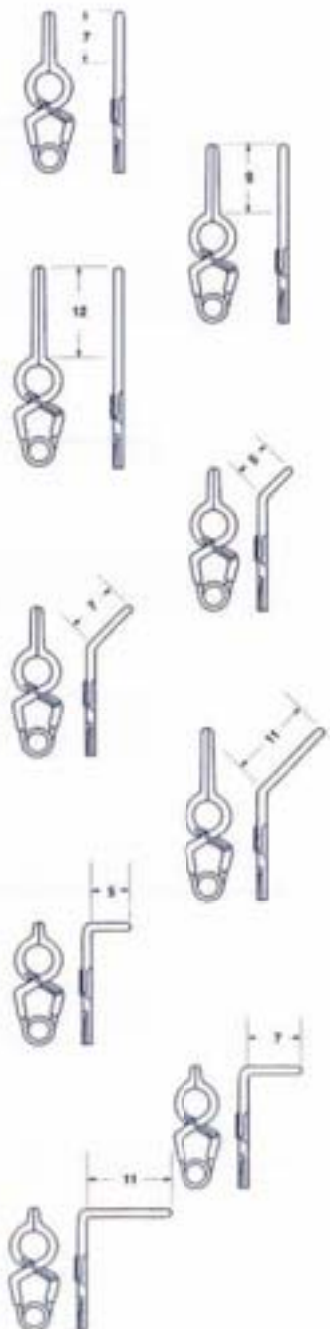







Öffnung max. opening	Druck Force	Artikel-Nummer Cat. No.
7,4 mm 7,4 mm	110 gms 110 gms	55-0003-86 ST 55-0003-86 S
8,4 mm 8,4 mm	110 gms 110 gms	55-0003-87 ST 55-0003-87 S
9,6 mm 9,6 mm	90 gms 90 gms	55-0003-88 ST 55-0003-88 S
5,8 mm 5,8 mm	110 gms 110 gms	55-0003-89 ST 55-0003-89 S
6,5 mm 6,5 mm	110 gms 110 gms	55-0003-90 ST 55-0003-90 S
7,2 mm 7,2 mm	110 gms 110 gms	55-0003-91 ST 55-0003-91 S
4,9 mm 4,9 mm	110 gms 110 gms	55-0003-92 ST 55-0003-92 S
4,9 mm 4,9 mm	110 gms 110 gms	55-0003-93 ST 55-0003-93 S
4,9 mm 4,9 mm	110 gms 110 gms	55-0003-94 ST 55-0003-94 S



Aneurysmen-Clips für permanenten Verschluss, gefenestert, 5,0 mm **Standard**
 Aneurysm-Clip for permanent closure, fenestrated, 5,0 mm

ST: TITAN/TITANIUM





S: Implantatstahl/implant-Steel

Öffnung max. opening	Druck Force	Artikel-Nummer Cat. No.		
7,9 mm 7,9 mm	150 gms 150 gms	55-0003-95 ST 55-0003-95 S		
9,1 mm 9,1 mm	150 gms 150 gms	55-0003-96 ST 55-0003-96 S		
10,3 mm 10,3 mm	180 gms 180 gms	55-0003-97 ST 55-0003-97 S		
6,5 mm 6,5 mm	150 gms 150 gms	55-0003-98 ST 55-0003-98 S		
7,2 mm 7,2 mm	150 gms 150 gms	55-0003-99 ST 55-0003-99 S		
7,8 mm 7,8 mm	180 gms 180 gms	55-0003-100 ST 55-0003-100 S		
5,5 mm 5,5 mm	150 gms 150 gms	55-0003-101 ST 55-0003-101 S		
5,5 mm 5,5 mm	150 gms 150 gms	55-0003-102 ST 55-0003-102 S		

Aneurysmen-Clips für permanenten Verschluss, gefenestert, 5,0 mm Standard
 Aneurysm-Clip for permanent closure, fenestrated, 5,0 mm

*ST: TITAN/TITANIUM

*S: Implantatstahl/Implant-Steel



















Öffnung max. opening	Druck Force	Artikel-Nummer Cat. No.	
5,5 mm 5,5 mm	180 gms 180 gms	55-0003-103 ST 55-0003-103 S	
7,9 mm 7,9 mm	150 gms 150 gms	55-0003-104 ST 55-0003-104 S	
8,8 mm 8,8 mm	150 gms 150 gms	55-0003-105 ST 55-0003-105 S	
10,0 mm 10,0 mm	180 gms 180 gms	55-0003-106 ST 55-0003-106 S	

Aneurysmen-Clips für temporären Verschluss, gefenestert, 5,0 mm
Aneurysm-Clip for temporary closure, fenestrated, 5,0 mm

Standard

ST: TITAN/TITANIUM

S: Implantatstahl/implant-Steel

Öffnung max. opening	Druck Force	Artikel-Nummer Cat. No.		
7,9 mm 7,9 mm	110 gms 110 gms	55-0003-107 ST 55-0003-107 S		
9,1 mm 9,1 mm	100 gms 100 gms	55-0003-108 ST 55-0003-108 S		
10,3 mm 10,3 mm	90 gms 90 gms	55-0003-109 ST 55-0003-109 S		
6,5 mm 6,5 mm	110 gms 110 gms	55-0003-110 ST 55-0003-110 S		
7,2 mm 7,2 mm	110 gms 110 gms	55-0003-111 ST 55-0003-111 S		
7,8 mm 7,8 mm	110 gms 110 gms	55-0003-112 ST 55-0003-112 S		
5,5 mm 5,5 mm	110 gms 110 gms	55-0003-113 ST 55-0003-113 S		
5,5 mm 5,5 mm	110 gms 110 gms	55-0003-114 ST 55-0003-114 S		

Aneurysmen-Clips für temporären Verschuß, gefenestert, 5,0 mm Standard
 Aneurysm-Clip for temporary closure, fenestrated, 5,0 mm

ST: TITAN/TITANIUM

S: Implantatstahl/implant-Steel



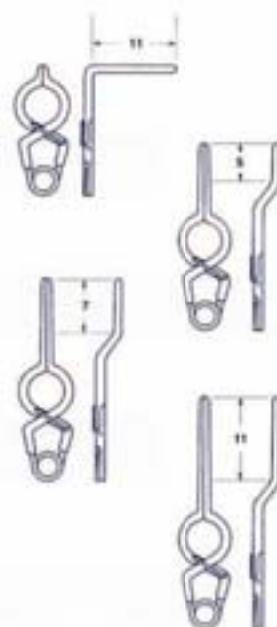





Öffnung max. opening	Druck Force	Artikel-Nummer Cat. No.
5,5 mm 5,5 mm	90 gms 90 gms	55-0003-115 ST 55-0003-115 S
7,9 mm 7,9 mm	90 gms 90 gms	55-0003-116 ST 55-0003-116 S
8,8 mm 8,8 mm	90 gms 90 gms	55-0003-117 ST 55-0003-117 S
10,0 mm 10,0 mm	90 gms 90 gms	55-0003-118 ST 55-0003-118 S

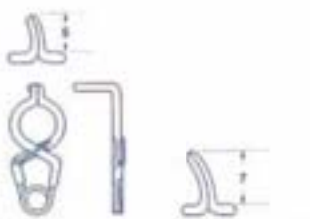

Aneurysmen-Clips für permanenten Verschuß gefenestert, 5,0 mm **Standard**
 Aneurysm-Clip for permanent closure, fenestrated, 5,0 mm

ST: TITAN/TITANIUM











S: Implantstahl/implant-Steel

Öffnung max. opening	Druck Force	Artikel-Nummer Cat. No.	
5,8 mm 5,8 mm	150 gms 150 gms	55-0003-119 ST 55-0003-119 S	
5,8 mm 5,8 mm	150 gms 150 gms	55-0003-121 ST 55-0003-121 S	
5,8 mm 5,8 mm	150 gms 150 gms	55-0003-123 ST 55-0003-123 S	
5,8 mm 5,8 mm	150 gms 150 gms	55-0003-125 ST 55-0003-125 S	
5,8 mm 5,8 mm	150 gms 150 gms	55-0003-127 ST 55-0003-127 S	
7,0 mm 7,0 mm	150 gms 150 gms	55-0003-129 ST 55-0003-129 S	
7,8 mm 7,8 mm	150 gms 150 gms	55-0003-131 ST 55-0003-131 S	
8,8 mm 8,8 mm	150 gms 150 gms	55-0003-133 ST 55-0003-133 S	

Aneurysmen-Clips für permanenten Verschluss gefenestert, 5,0 mm Standard
 Aneurysm-Clip for permanent closure, fenestrated, 5,0 mm

ST: TITAN/TITANIUM

S: Implantatstahl/Implant-Steel









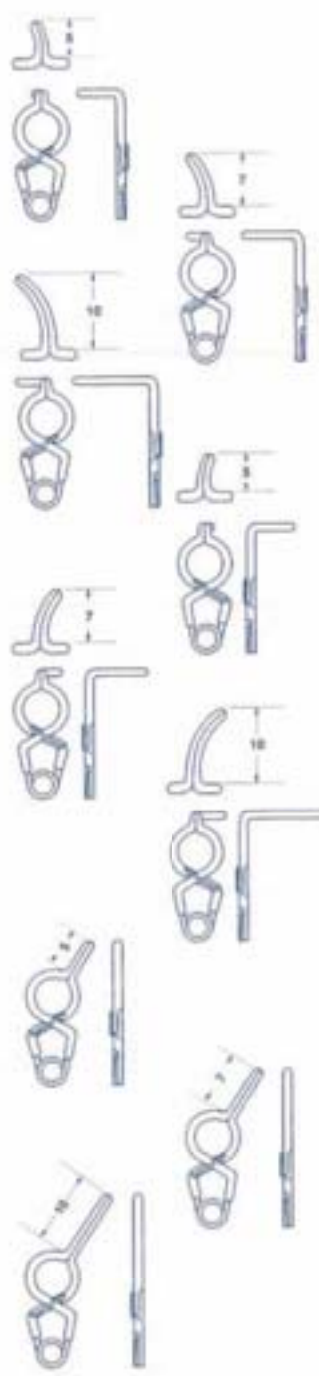

Öffnung max. opening	Druck Force	Artikel-Nummer Cat. No.		
5,8 mm 5,8 mm	150 gms 150 gms	55-0003-128 ST 55-0003-128 S		
6,2 mm 6,2 mm	150 gms 150 gms	55-0003-129 ST 55-0003-129 S		
5,8 mm 5,8 mm	150 gms 150 gms	55-0003-130 ST 55-0003-130 S		
6,2 mm 6,2 mm	150 gms 150 gms	55-0003-131 ST 55-0003-131 S		
5,6 mm 5,6 mm	150 gms 150 gms	55-0003-132 ST 55-0003-132 S		
5,6 mm 5,6 mm	150 gms 150 gms	55-0003-133 ST 55-0003-133 S		
5,6 mm 5,6 mm	150 gms 150 gms	55-0003-134 ST 55-0003-134 S		
5,6 mm 5,6 mm	150 gms 150 gms	55-0003-135 ST 55-0003-135 S		

Aneurysmen-Clips für temporären Verschluss, gefenestert, 5,0 mm
 Aneurysm-Clip for temporary closure, fenestrated, 5,0 mm

Standard

ST: TITAN/TITANIUM

S: Implantatstahl/implant-Steel



















Öffnung max. opening	Druck Force	Artikel-Nummer Cat. No.	
5,8 mm 5,8 mm	110 gms 110 gms	55-0003-136 ST 55-0003-136 S	
5,8 mm 5,8 mm	110 gms 110 gms	55-0003-137 ST 55-0003-137 S	
5,8 mm 5,8 mm	110 gms 110 gms	55-0003-138 ST 55-0003-138 S	
5,8 mm 5,8 mm	110 gms 110 gms	55-0003-139 ST 55-0003-139 S	
5,8 mm 5,8 mm	110 gms 110 gms	55-0003-140 ST 55-0003-140 S	
5,8 mm 5,8 mm	110 gms 110 gms	55-0003-141 ST 55-0003-141 S	
7,0 mm 7,0 mm	110 gms 110 gms	55-0003-142 ST 55-0003-142 S	
7,8 mm 7,8 mm	110 gms 110 gms	55-0003-143 ST 55-0003-143 S	
8,8 mm 8,8 mm	110 gms 110 gms	55-0003-144 ST 55-0003-144 S	

Aneurysmen-Clips für temporären Verschuß, gefenestert, 5,0 mm
 Aneurysm-Clip for temporary closure, fenestrated, 5,0 mm

Standard

*ST: TITAN/TITANIUM

*S: Implantatstahl/implant-Steel

Öffnung max. opening	Druck Force	Artikel-Nummer Cat. No.		
5,8 mm 5,8 mm	110 gms 110 gms	55-0003-145 ST 55-0003-145 S		
6,2 mm 6,2 mm	110 gms 110 gms	55-0003-146 ST 55-0003-146 S		
5,8 mm 5,8 mm	110 gms 110 gms	55-0003-147 ST 55-0003-147 S		
6,2 mm 6,2 mm	110 gms 110 gms	55-0003-148 ST 55-0003-148 S		
5,6 mm 5,6 mm	110 gms 110 gms	55-0003-149 ST 55-0003-149 S		
5,6 mm 5,6 mm	110 gms 110 gms	55-0003-150 ST 55-0003-150 S		
5,6 mm 5,6 mm	110 gms 110 gms	55-0003-151 ST 55-0003-151 S		
5,6 mm 5,6 mm	110 gms 110 gms	55-0003-152 ST 55-0003-152 S		

Aneurysmen-Clips für permanenten Verschluss
 Aneurysm-Clip for permanent closure

Mini

MT: TITAN/TITANIUM

M: Implantatstahl/Implant-Steel

Öffnung max. opening	Druck Force	Artikel-Nummer Cat. No.
3,3 mm 3,3 mm	110 gms 110 gms	55-0004-01 M 55-0004-01 MT
4,0 mm 4,0 mm	110 gms 110 gms	55-0004-02 M 55-0004-02 MT
3,3 mm 3,3 mm	110 gms 110 gms	55-0004-03 M 55-0004-03 MT
4,0 mm 4,0 mm	110 gms 110 gms	55-0004-04 M 55-0004-04 MT
4,6 mm 4,6 mm	110 gms 110 gms	55-0004-05 M 55-0004-05 MT
3,2 mm 3,2 mm	110 gms 110 gms	55-0004-06 M 55-0004-06 MT
3,8 mm 3,8 mm	110 gms 110 gms	55-0004-07 M 55-0004-07 MT
3,6 mm 3,6 mm	110 gms 110 gms	55-0004-08 M 55-0004-08 MT
3,8 mm 3,8 mm	110 gms 110 gms	55-0004-09 M 55-0004-09 MT
3,6 mm 3,6 mm	110 gms 110 gms	55-0004-10 M 55-0004-10 MT



Aneurysmen-Clips für permanenten Verschuß

Aneurysm-Clip for permanent closure

Mini

MT: TITAN/TITANIUM

M: Implantatstahl/implant-Steel

Öffnung max. opening	Druck Force	Artikel-Nummer Cat. No.
4,0 mm 4,0 mm	110 gms 110 gms	55-0004-11 M 55-0004-11 MT
4,4 mm 4,4 mm	110 gms 110 gms	55-0004-12 M 55-0004-12 MT
3,6 mm 3,6 mm	110 gms 110 gms	55-0004-13 M 55-0004-13 MT
3,5 mm 3,5 mm	110 gms 110 gms	55-0004-14 M 55-0004-14 MT
4,0 mm 4,0 mm	110 gms 110 gms	55-0004-15 M 55-0004-15 MT
3,5 mm 3,5 mm	130 gms 130 gms	55-0004-16 M 55-0004-16 MT
6,0 mm 6,0 mm	130 gms 130 gms	55-0004-17 M 55-0004-17 MT
7,0 mm 7,0 mm	130 gms 130 gms	55-0004-18 M 55-0004-18 MT
5,7 mm 5,7 mm	130 gms 130 gms	55-0004-19 M 55-0004-19 MT
4,5 mm 4,5 mm	130 gms 130 gms	55-0004-20 M 55-0004-20 MT



Aneurysmen-Clips für temporären Verschluss
Aneurysm-Clip for temporary closure

Mini

MT: TITAN/TITANIUM

M: Implantatstahl/Implant-Steel

Öffnung max. opening	Druck Force	Artikel-Nummer Cat. No.
3,3 mm 3,3 mm	90 gms 90 gms	55-0004-21 M 55-0004-21 MT
4,0 mm 4,0 mm	70 gms 70 gms	55-0004-22 M 55-0004-22 MT
3,3 mm 3,3 mm	90 gms 90 gms	55-0004-23 M 55-0004-23 MT
4,0 mm 4,0 mm	70 gms 70 gms	55-0004-24 M 55-0004-24 MT
4,6 mm 4,6 mm	70 gms 70 gms	55-0004-25 M 55-0004-25 MT
3,2 mm 3,2 mm	90 gms 90 gms	55-0004-26 M 55-0004-26 MT
3,8 mm 3,8 mm	70 gms 70 gms	55-0004-27 M 55-0004-27 MT
3,6 mm 3,6 mm	80 gms 80 gms	55-0004-28 M 55-0004-28 MT
3,8 mm 3,8 mm	70 gms 70 gms	55-0004-29 M 55-0004-29 MT
3,6 mm 3,6 mm	80 gms 80 gms	55-0004-30 M 55-0004-30 MT



Aneurysmen-Clips für temporären Verschluss
 Aneurysm-Clip for temporary closure

Mini

MT: TITAN/TITANIUM

M: Implantatstahl/implant-Steel

Öffnung max. opening	Druck Force	Artikel-Nummer Cat. No.
4,0 mm 4,0 mm	70 gms 70 gms	55-0004-31 M 55-0004-31 MT
4,4 mm 4,4 mm	70 gms 70 gms	55-0004-32 M 55-0004-32 MT
3,6 mm 3,6 mm	80 gms 80 gms	55-0004-33 M 55-0004-33 MT
3,5 mm 3,5 mm	80 gms 80 gms	55-0004-34 M 55-0004-34 MT
4,0 mm 4,0 mm	70 gms 70 gms	55-0004-35 M 55-0004-35 MT
3,5 mm 3,5 mm	70 gms 70 gms	55-0004-36 M 55-0004-36 MT
6,0 mm 6,0 mm	70 gms 70 gms	55-0004-37 M 55-0004-37 MT
7,0 mm 7,0 mm	70 gms 70 gms	55-0004-38 M 55-0004-38 MT
5,7 mm 5,7 mm	70 gms 70 gms	55-0004-39 M 55-0004-39 MT
4,5 mm 4,5 mm	70 gms 70 gms	55-0004-40 M 55-0004-40 MT



Anlegezangen für YASARGIL Aneurysmen-Clips
 Applying Forceps for YASARGIL Aneurysm-Clip



Schaftlänge Artikel-Nummer
 Length of shaft Cat. No.

Standard

70 mm	55-0006-31
90 mm	55-0006-32
110 mm	55-0006-33
130 mm	55-0006-35



Maul drehbar
 Mouth rotating

70 mm	55-0006-31 T
90 mm	55-0006-32 T
110 mm	55-0006-33 T
130 mm	55-0006-35 T



Maul drehbar
 Mouth rotating

70 mm	55-0006-28
90 mm	55-0006-29
110 mm	55-0006-30
130 mm	55-0006-34



Maul starr
 Mouth fixed

70 mm	55-0006-28 T
90 mm	55-0006-29 T
110 mm	55-0006-30 T
130 mm	55-0006-34 T



Maul starr
 Mouth fixed

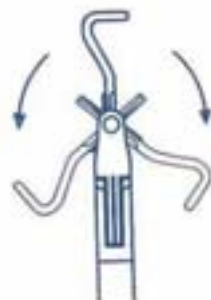

Anlegezangen für YASARGIL Aneurysmen-Clips
 Applying Forceps for YASARGIL Aneurysm-Clip



Schaftlänge **Artikel-Nummer**
 Length of shaft Cat. No.

Mini

70 mm	55-0006-21
90 mm	55-0006-22
110 mm	55-0006-23
130 mm	55-0006-25



Maul drehbar
 Mouth rotating

70 mm	55-0006-21 T
90 mm	55-0006-22 T
110 mm	55-0006-23 T
130 mm	55-0006-25 T



Maul drehbar
 Mouth rotating

70 mm	55-0006-18
90 mm	55-0006-19
110 mm	55-0006-20
130 mm	55-0006-24



Maul starr
 Mouth fixed

70 mm	55-0006-18 T
90 mm	55-0006-19 T
110 mm	55-0006-20 T
130 mm	55-0006-24 T



Maul starr
 Mouth fixed

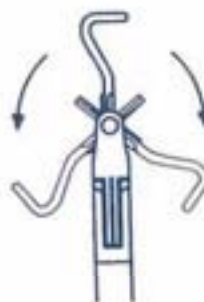

Anlegezangen für YASARGIL Aneurysmen-Clips
 Applying Forceps for YASARGIL Aneurysm-Clip

Schaftlänge Artikel-Nummer
 Length of shaft Cat. No.

Standard

70 mm	55-0006-01
90 mm	55-0006-02
110 mm	55-0006-03



Maul drehbar
 Mouth rotating

70 mm	55-0006-01 T
90 mm	55-0006-02 T
110 mm	55-0006-03 T



Maul drehbar
 Mouth rotating

70 mm	55-0006-04
90 mm	55-0006-05
110 mm	55-0006-06



Maul starr
 Mouth fixed

70 mm	55-0006-04 T
90 mm	55-0006-05 T
110 mm	55-0006-06 T



Maul starr
 Mouth fixed

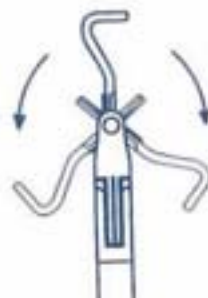

Anlegezangen für YASARGIL Aneurysmen-Clips Applying Forceps for YASARGIL Aneurysm-Clip

Schaftlänge Artikel-Nummer
Length of shaft Cat. No.

Mini

70 mm	55-0006-07
90 mm	55-0006-08
110 mm	55-0006-09



Maul drehbar
Mouth rotating

70 mm	55-0006-07 T
90 mm	55-0006-08 T
110 mm	55-0006-09 T



Maul drehbar
Mouth rotating

70 mm	55-0006-10
90 mm	55-0006-11
110 mm	55-0006-12



Maul starr
Mouth fixed

70 mm	55-0006-10 T
90 mm	55-0006-11 T
110 mm	55-0006-12 T



Maul starr
Mouth fixed

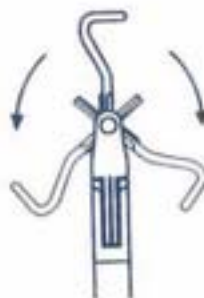

Anlegezangen für YASARGIL Aneurysmen-Clips
Applying Forceps for YASARGIL Aneurysm-Clip

Schaftlänge Artikel-Nummer
Length of shaft Cat. No.

Standard

180 mm 55-0006-58
180 mm 55-0006-58 T



Maul starr
Mouth fixed



180 mm 55-0006-58 D
180 mm 55-0006-58 DT

Maul drehbar
Mouth rotating

Mini

180 mm 55-0006-48
180 mm 55-0006-48 T



Maul starr
Mouth fixed



180 mm 55-0006-49
180 mm 55-0006-49 T

Maul drehbar
Mouth rotating



1/1

Anlegezangen für YASARGIL Aneurysmen-Clips Applying Forceps for YASARGIL Aneurysm-Clip

Schaftlänge Artikel-Nummer
Length of shaft Cat. No.

Standard

170 mm	55-0006-50
210 mm	55-0006-52
230 mm	55-0006-54
170 mm	55-0006-50 T
210 mm	55-0006-52 T
230 mm	55-0006-54 T



170 mm	55-0006-50 D
210 mm	55-0006-52 D
230 mm	55-0006-54 D
170 mm	55-0006-50 DT
210 mm	55-0006-52 DT
230 mm	55-0006-54 DT



Mini

170 mm	55-0006-40
210 mm	55-0006-42
230 mm	55-0006-44
170 mm	55-0006-40 T
210 mm	55-0006-42 T
230 mm	55-0006-44 T



170 mm	55-0006-40 D
210 mm	55-0006-42 D
230 mm	55-0006-44 D
170 mm	55-0006-40 DT
210 mm	55-0006-42 DT
230 mm	55-0006-44 DT



1/1

Gefäßclips
 Vessel Clips

2/1





Biemer	Maulöffnung Opening	Maullänge Length of jaw	Schließkraft Closing force	Artikel-Nummer Cat. No.
	4,0 mm	6,0 mm	30 – 40 g	55-0005-60
	5,0 mm	9,0 mm	30 – 40 g	55-0005-61
	5,0 mm	9,0 mm	20 – 25 g	55-0005-62

Mehdorn	Maul Jaw	Schließkraft Closing force	Artikel-Nummer Cat. No.
	4 x 1,0 mm	10 – 15 g	55-0005-52
	4 x 1,4 mm	15 – 20 g	55-0005-54
	6 x 1,0 mm	10 – 15 g	55-0005-56
	6 x 1,4 mm	15 – 20 g	55-0005-58

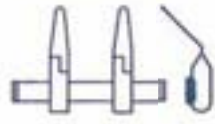
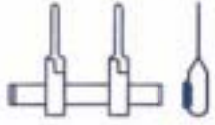
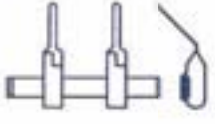

2/1

Approximatoren Approximators

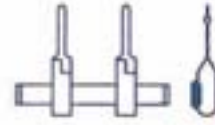
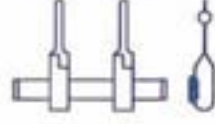
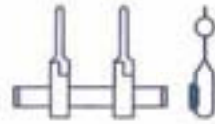
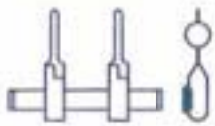
	Maulöffnung Opening	Maullänge Length of jaw	Schließkraft Closing force	Artikel-Nummer Cat. No.	
 1/1	5,0 mm	9,0 mm	25 – 30 g	55-0002-11	
	5,0 mm	9,0 mm	25 – 30 g	55-0002-12	
	5,0 mm	9,0 mm	25 – 30 g	55-0002-13	
	5,0 mm	9,0 mm	25 – 30 g	55-0002-14	
	5,0 mm	9,0 mm	25 – 30 g	55-0002-15	
 1/1	1,0 mm		25 – 30 g	55-0005-71	
	2,0 mm		25 – 30 g	55-0005-72	
	3,0 mm		25 – 30 g	55-0005-73	
	4,0 mm		25 – 30 g	55-0005-74	

Biemer Approximator

mit Anlegepinzette / with Applying forceps
allein / only

Artikel-Nummer
Cat. No.

55-0001-70
55-0001-71



mit Schlüssel / with key

55-0001-75







mit Schlüssel / with key
1 Paar Ersatznadeln / spare needles

55-0001-35
55-0001-38



Gefäßclips / Vessel clips
Klemmen / Ligature forceps

Atraumatische Gefäßclips
 Atraumatic vessel clips

	Länge Length	Schließkraft Closing force	Artikel-Nummer Cat. No.	
Müller	38 mm	50 g 80 g	55-0002-10 55-0002-20	
		50 g 80 g	55-0002-11 55-0002-21	
		50 g 80 g	55-0002-12 55-0002-22	
1/1		50 g 80 g	55-0002-13 55-0002-23	
		50 g 80 g	55-0002-14 55-0002-24	

Fadenklemme, Maul fein, kariert
 Ligature forceps, jaw profile finely, cross-serrated

Müller

Länge Length	Artikel-Nummer Cat. No.
38 mm	55-0002-05



YASARGIL Mikro-Gefäß-Clips
 Micro vessel clips

Länge Length	Artikel-Numr Cat. No.
32 mm	55-0002-17



1/1

YASARGIL Anlegepinzette für Gefäßclips
 Applying forceps for micro vessel clips

Länge Length	Artikel-Nummer Cat. No.
180 mm	55-0002-19



1/2

Anlegepinzetten Applying forceps

Anlegepinzetten für Gefäßclips und Approximatoren
Applying forceps for vessel clips an approximators

Biemer	Gesamtlänge Total length	Artikel-Nummer Cat. No.
ohne Schloß / without lock	145 mm	55-0005-68
mit Schloß / with lock	145 mm	55-0005-69
für Gefäßclips / for vessel-clips und Approximatoren / and approximators		(55-0005-68 - 55-0005-62) (55-0002-11 - 55-0002-74)









Biemer	Gesamtlänge Total length	Artikel-Nummer Cat. No.
ohne Schloß / without lock	145 mm	55-0005-72
für Approximator / for approximator		(55-0001-71)



Mehdorn	Gesamtlänge Total length	Artikel-Nummer Cat. No.
ohne Schloß / without lock	145 mm	55-0005-78
für Gefäßclips / for vessel-clips		(55-0005-52 - 55-0005-58)



Gefäßklemmen / Vessel clamps
Bulldogklemmen / Bulldog clamps

	Gesamtlänge Total length	Artikel-Nummer Cat. No.		
				 17-0040-40 - 17-0043-45
De Bakey	40 mm	17-0040-40		 17-0010-50 17-0011-50
	40 mm	17-0041-40		
	45 mm	17-0040-45		
	45 mm	17-0041-45		
	40 mm	17-0042-40		
	45 mm	17-0043-45		
De Bakey (Atraumatisch / atraumatic)	50 mm	17-0010-50		 17-0013-57
	50 mm	17-0011-50		1/1
Glover	57 mm	17-0013-57	 1/1	
De Bakey	73 mm	17-0015-73	 1/1	 17-0015-73

Gefäßklemmen / Vessel clamps
Bulldogklemmen / Bulldog clamps

	Gesamtlänge Total length	Maullänge Length of jaw	Artikel-Nummer Cat. No.
De Bakey <i>(Atraumatisch / Atraumatic)</i>	80 mm	25 mm	17-0060-25
	90 mm	35 mm	17-0060-35
	105 mm	50 mm	17-0060-50
	124 mm	68 mm	17-0060-68
De Bakey <i>(Atraumatisch / Atraumatic)</i>	78 mm	25 mm	17-0061-25
	86 mm	35 mm	17-0061-35
	97 mm	50 mm	17-0061-50
	114 mm	68 mm	17-0061-68
Glover <i>(Atraumatisch / Atraumatic)</i>	68 mm	33 mm	17-0016-33
	96 mm	50 mm	17-0016-50
	117 mm	69 mm	17-0016-69
Glover <i>(Atraumatisch / Atraumatic)</i>	65 mm	33 mm	17-0017-33
	91 mm	50 mm	17-0017-50
	110 mm	69 mm	17-0017-69



1/1



1/1

Hirnspatel, biegsam

Brain spatulas, malleable

	Breite Width	Gesamtlänge Total length	Artikel-Nummer Cat. No.
Cushing	7 + 9 mm	180 mm	45-1025-07
	11 + 13 mm	180 mm	45-1025-11
	15 + 18 mm	180 mm	45-1025-15
	18 + 22 mm	180 mm	45-1025-18



1/2

Cushing	9 mm	200 mm	45-1011-09
	12 mm	200 mm	45-1011-12
	12 mm	250 mm	45-1012-12

1/2

Olivecrona	7 + 9 mm	180 mm	45-1046-07
	11 + 13 mm	180 mm	45-1046-11
	15 + 18 mm	180 mm	45-1046-15
	18 + 22 mm	180 mm	45-1046-18

1/2





Hirnspatel, biegsam
Brain spatulas, malleable

	Breite Width	Gesamtlänge Total length	Artikel-Nummer Cat. No.
Olivecrona	14 mm	200 mm	45-1032-14
	17 mm	200 mm	45-1032-17
	20 mm	200 mm	45-1032-20

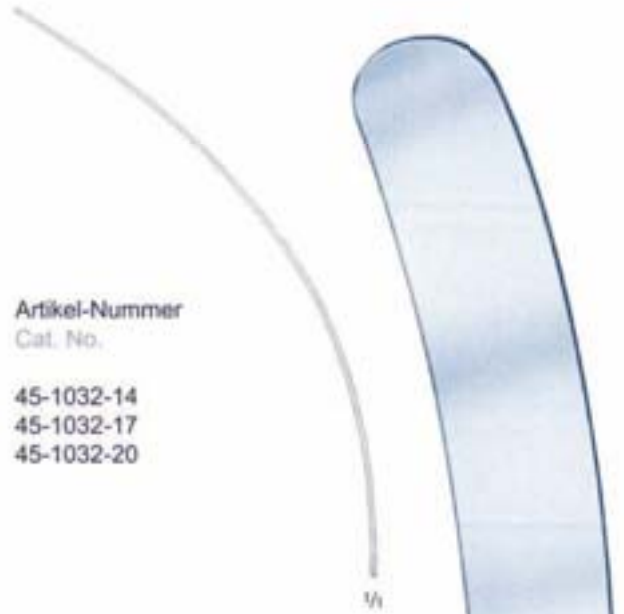

Heifetz	8 mm	155 mm	45-1034-08
	11 mm	155 mm	45-1034-11
	14 mm	155 mm	45-1034-14
	17 mm	155 mm	45-1034-17



1/1

**Kopfhautklammern / Scalp haemostasis
Galeahaken / Galea hook**



Galeahaken
Galea hooks

Yasargil

Feder
Spring

7 mm
9 mm

Gesamtlänge
Total length

310 mm
410 mm

Artikel-Nummer
Cat. No.

24-0081-07
24-0081-09

1/2

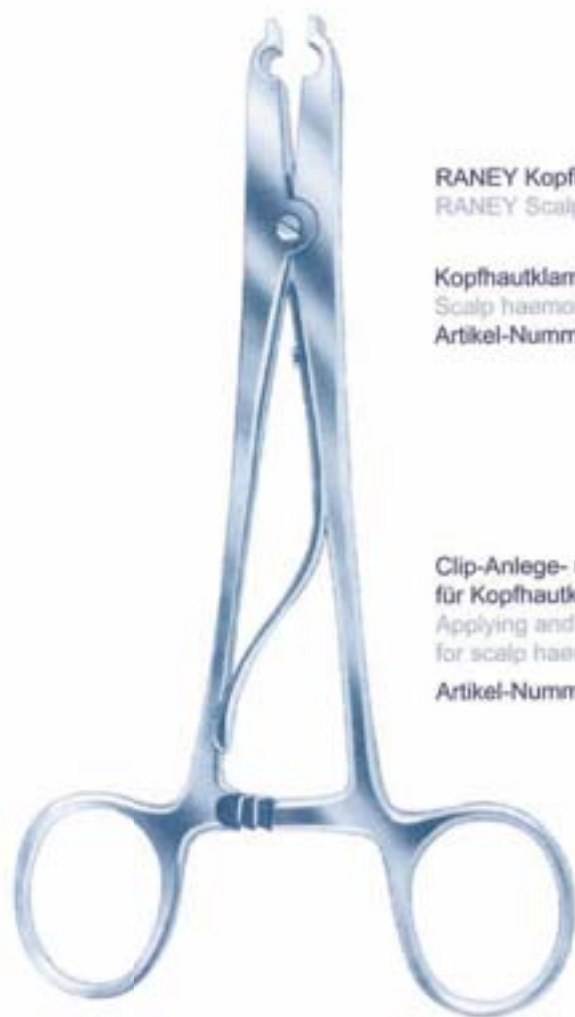

RANEY Kopfhautklammern
RANEY Scalp haemostasis clips

Kopfhautklammer, Packung à 25 Stück
Scalp haemostasis clip, package of 25 clips
Artikel-Nummer / Cat. No. 45-0061-01







Clip-Anlege- und Abnehmezange
für Kopfhautklammer, 16 cm
Applying and removing forceps
for scalp haemostasis clips, 6 3/4"

Artikel-Nummer / Cat. No. 45-0061-02

Kölner Sparklammer
Cologne sparkclip
45-0060-00



Hypophysen- und Tumorzangen
 Pituitary rongeurs and tumor grasping forceps

	Schaftlänge Length of shaft	Artikel-Nummer Cat. No.	
Scharfe Hypophysenzange / Sharp pituitary rongeur			
Oldberg	180 mm	45-0030-18	ø 7 mm
Scharfe Hypophysenzange / Sharp pituitary rongeur			
Landolt	190 mm	45-0032-19	ø 2,2 mm
Scharfe Hypophysenzange / Sharp pituitary rongeur			
Yasargil	190 mm	45-0034-19	ø 3,5 mm
Tumor-Faßzange, stumpf / Tumor grasping forceps, blunt			
Landolt	200 mm	45-0036-20	ø 9 mm

Rongeurs
Rongeurs

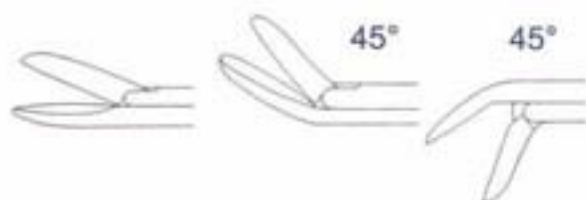
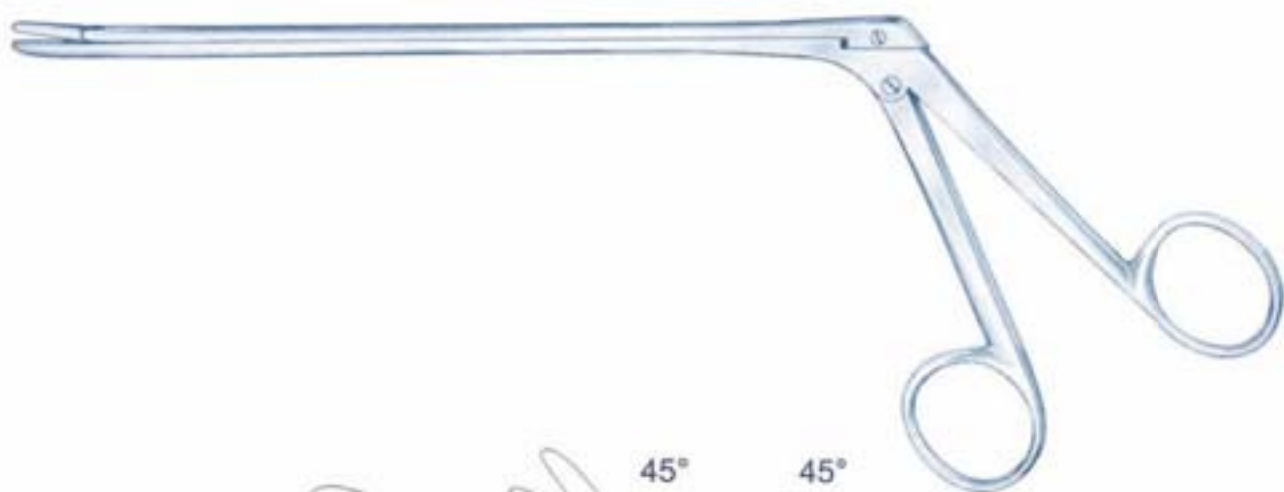

Schaftlänge
Length of shaft

Cushing
2 x 10 mm
125 mm
180 mm

Love-Gruenwald
3 x 10 mm
125 mm

Spurling
4 x 10 mm
125 mm
180 mm

Caspar
2 mm
155 mm
3 mm
155 mm
4 mm
155 mm
5 mm
155 mm

45-0420-13
45-0420-18

45-0430-13
45-0430-18

45-0440-13
45-0440-18





Stanzen
Punches

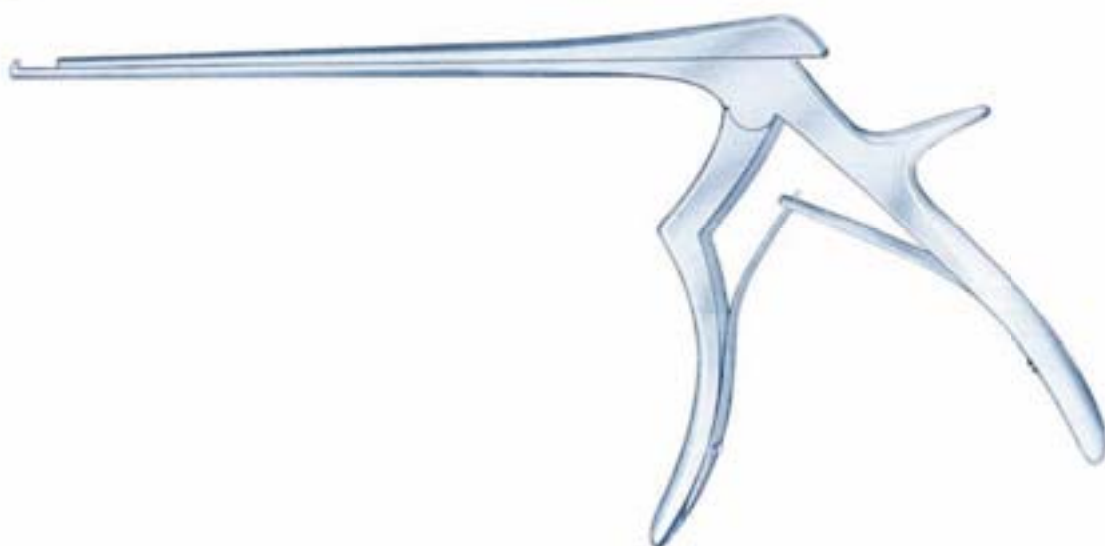

	90°	90°	130°	130°	
Schaftlänge 180 mm Length of shaft 180 mm					
1 mm Kerrison-Jacoby Ferris-Smith-Kerrison	45-0503-01	45-0504-01	45-0501-01	45-0502-01	0
2 mm Kerrison-Jacoby Ferris-Smith-Kerrison	45-0503-02	45-0504-02	45-0501-02	45-0502-02	Δ
3 mm Ferris-Smith-Kerrison	45-0503-03	45-0504-03	45-0501-03	45-0502-03	□
4 mm Ferris-Smith-Kerrison	45-0503-04	45-0504-04	45-0501-04	45-0502-04	□
5 mm Ferris-Smith-Kerrison	45-0503-05	45-0504-05	45-0501-05	45-0502-05	□
Schaftlänge 215 mm length of shaft 215 mm			130° 	130° 	
Kerrison					
2 mm			45-0499-02	45-0500-02	
3 mm			45-0499-03	45-0500-03	
4 mm			45-0499-04	45-0500-04	
5 mm			45-0499-05	45-0500-05	
Knochenzangen mit dünner Fußplatte / Bone Punches with thin footplate					
Schaftlänge 175 mm length of shaft 175 mm					
1 mm			45-0476-01	45-0478-01	
2 mm			45-0476-02	45-0478-02	
3 mm			45-0476-03	45-0478-03	

auf Wunsch nach Ferris-Smith-Cushing Zusatzbuchstabe "F"
When desired after Ferris Smith Cushing addition letter „F“



Blakesley gerade straight

	Schaft Länge shaft length	Maul Höhe jaw height	Breite width	Länge length	Art.-Nr. Cat. No.
Fig. 00000	120 mm	3,5 mm	1,7	8,0 mm	45-0398-00 N
Fig. 00000	120 mm	3,5 mm	1,7	14,0 mm	45-0398-14 N
Fig. 00000	120 mm	3,5 mm	2,0	8,0 mm	45-0399-00 N
Fig. 00	120 mm	4,0 mm	2,5	8,0 mm	45-0401-00 N
Fig. 0	120 mm	4,0 mm	3,0	10,0 mm	45-0402-00 N
Fig. 1	120 mm	4,5 mm	3,5	10,0 mm	45-0403-00 N
Fig. 2	120 mm	5,0 mm	4,0	14,0 mm	45-0404-00 N
Fig. 3	120 mm	5,0 mm	4,5	14,0 mm	45-0405-00 N
Fig. 4	120 mm	5,0 mm	6,0	15,0 mm	45-0406-00 N



Blakesley 45°

Fig. 00000	120 mm	3,5 mm	1,7	8,0 mm	45-0408-00 N
Fig. 00000	120 mm	3,5 mm	2,0	8,0 mm	45-0409-00 N
Fig. 00	120 mm	4,0 mm	2,5	8,0 mm	45-0411-00 N
Fig. 0	120 mm	4,0 mm	3,0	10,0 mm	45-0412-00 N
Fig. 1	120 mm	4,5 mm	3,5	10,0 mm	45-0413-00 N
Fig. 2	120 mm	4,5 mm	4,0	13,0 mm	45-0414-00 N
Fig. 3	120 mm	4,5 mm	4,5	14,0 mm	45-0415-00 N
Fig. 4	120 mm	5,0 mm	6,0	14,0 mm	45-0416-00 N



Blakesley gerade / straight

Fig. 00000	170 mm	3,5 mm	1,7	8,0 mm	45-0388-00 N
Fig. 00000	170 mm	3,5 mm	2,0	8,0 mm	45-0389-00 N
Fig. 00	170 mm	4,0 mm	2,5	8,0 mm	45-0391-00 N
Fig. 0	170 mm	4,0 mm	3,0	10,0 mm	45-0392-00 N
Fig. 0	170 mm	4,0 mm	3,0	14,0 mm	45-0392-14 N
Fig. 1	170 mm	4,5 mm	3,5	10,0 mm	45-0393-00 N
Fig. 1	170 mm	4,5 mm	3,5	16,0 mm	45-0393-16 N
Fig. 2	170 mm	5,0 mm	4,0	14,0 mm	45-0394-00 N
Fig. 3	170 mm	5,0 mm	4,5	14,0 mm	45-0395-00 N
Fig. 4	170 mm	5,0 mm	6,0	15,0 mm	45-0396-00 N



Blakesley 45°

Fig. 00000	170 mm	3,5 mm	1,7	8,0 mm	45-0368-00 N
Fig. 00000	170 mm	3,5 mm	2,0	8,0 mm	45-0369-00 N
Fig. 00	170 mm	4,0 mm	2,5	8,0 mm	45-0371-00 N
Fig. 0	170 mm	4,0 mm	3,0	10,0 mm	45-0372-00 N
Fig. 1	170 mm	4,5 mm	3,5	10,0 mm	45-0373-00 N
Fig. 2	170 mm	4,5 mm	4,0	13,0 mm	45-0374-00 N
Fig. 3	170 mm	4,5 mm	4,5	14,0 mm	45-0375-00 N
Fig. 4	170 mm	5,0 mm	6,0	14,0 mm	45-0376-00 N



Duraschutzzange
Duraprotection

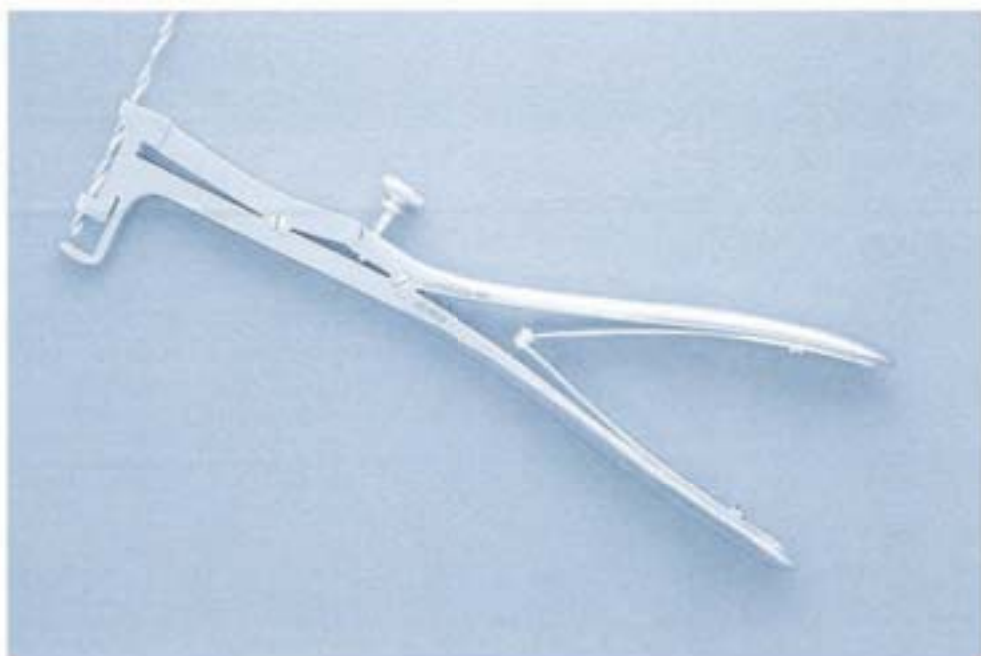

Duraschutzzange nach Clar
Duraprotection forceps acc. Clar
45-0010-00

Spiralbohrer
2,5 mm
Spiral drill
61-5152-00

Schnittfräser zum Craniotom
Cutting fraise to the cranium
45-0303-00



Tumorfazzange nach Tönnis

	Schaft Länge shaft length	Breite width	Länge length	Art.-Nr. product. no.
Fig. 1	105 mm	7 mm	200 mm	45-0604-01
Fig. 2	105 mm	10,0 mm	200 mm	45-0604-02
Fig. 3	105 mm	13,0 mm	200 mm	45-0604-03
Fig. 4	105 mm	16,0 mm	200 mm	45-0604-04



1



2



3



4

Wirbelsäule
Spine

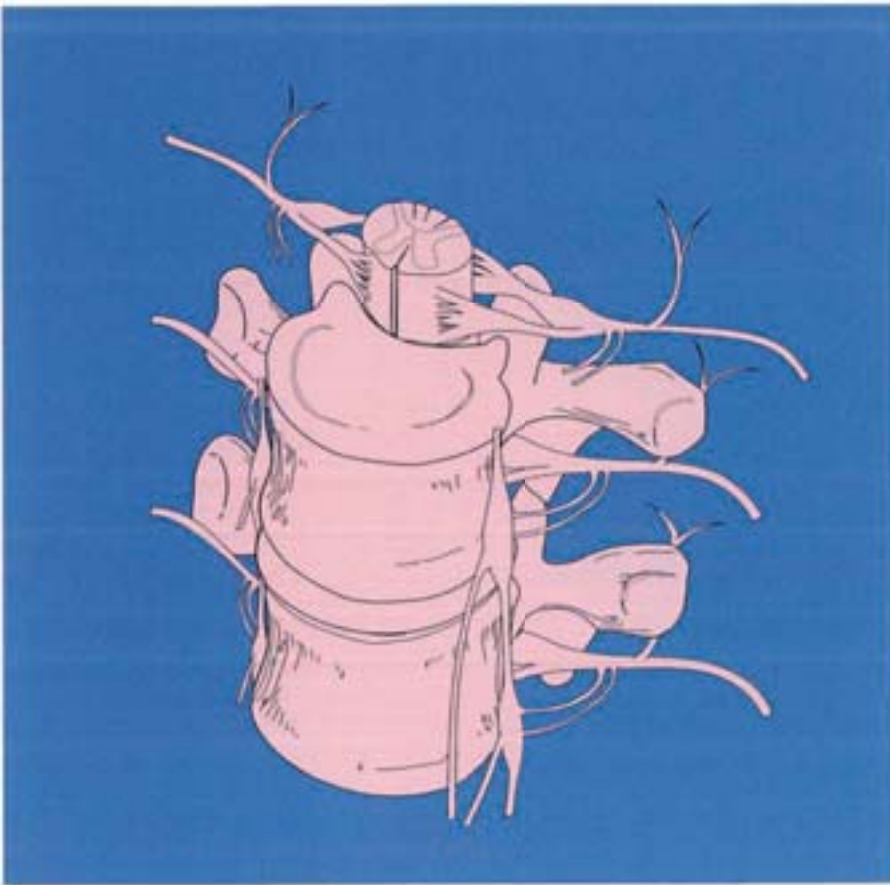

Spekula für Rückenoperationen
Specula for lumbar vertebral operations



	Blattlänge Length of blades	Artikel-Nummer Cat. No.
Caspar	45 mm	45-0095-45
	50 mm	45-0095-50
	55 mm	45-0095-55
	60 mm	45-0095-60
	65 mm	45-0095-65

Gegensperrer, komplett mit 7 Blättern
Counter retractor, complete with 7 blades
(26-2282-40 – 26-2282-70)

	Artikel-Nummer Cat. No.
Caspar	26-2282-00
Gegensperrer, alleine Counter retractor, only	26-2282-02



Blätter alleine / Blades only
Blattlänge
Length of blades

	Artikel-Nummer Cat. No.
40 mm	26-2282-40
45 mm	26-2282-45
50 mm	26-2282-50
55 mm	26-2282-55
60 mm	26-2282-60
65 mm	26-2282-65
70 mm	26-2282-70



Spekula für Rückenoperationen Specula for lumbar vertebral operations

	Blattlänge Length of blades	Artikel-Nummer Cat. No.
Caspar	40 mm	45-0096-40
	45 mm	45-0096-45
	50 mm	45-0096-50
	55 mm	45-0096-55
	60 mm	45-0096-60
	65 mm	45-0096-65
	75 mm	45-0096-75
	85 mm	45-0096-85



Gegensperrer, komplett mit 6 Blättern
Counter retractor, complete with 6 blades
(26-2283-35 – 26-2283-60)

Caspar	26-2283-00
Gegensperrer, alleine Counter retractor, only	26-2283-02

Blätter alleine / Blades only
Blattlänge
Length of blades

	Artikel-Nummer Cat. No.
35 mm	26-2283-35
40 mm	26-2283-40
45 mm	26-2283-45
50 mm	26-2283-50
55 mm	26-2283-55
60 mm	26-2283-60
65 mm	26-2283-65
75 mm	26-2283-75
85 mm	26-2283-85



Wundspreizer für die Wirbelsäule
Retractors for spine

Caspar

Sperrer mit 10 Blättern

Retractor with 10 blades

(26-2284-40 - 26-2284-60, 26-2281-40- 26-2281-60)

Sperrer, alleine / Retractor, only

Artikel-Nummer

Cat. No.

26-2284-00

26-2284-02



Caspar

Gegensperrer mit 5 Blättern

Counter retractor with 5 blades

(26-2285-45 - 26-2285-65)

Gegensperrer, alleine

Counter retractor, only

26-2281-00

26-2281-02



Caspar

Gegensperrer mit 5 Blättern

Counter retractor with 5 blades

(26-2285-45 - 26-2285-65)

Gegensperrer, alleine

Counter retractor, only

26-2285-00

26-2285-02



Caspar

Blätter-Wechselpinzette / Blade ejector

26-2285-03

Blätter für Wundspreizer

Blades for retractors

Blattlänge Length of blades	Artikel-Nummer Cat. No.
--------------------------------	----------------------------

Blätter, medial / medial blades, only, stainless steel

40 x 23 mm	26-2284-40
45 x 23 mm	26-2284-45
50 x 23 mm	26-2284-50
55 x 23 mm	26-2284-55
60 x 23 mm	26-2284-60

Blätter, medial, TITAN / medial blades, only, TITANIUM

25 x 24 mm	26-2284-25 T
30 x 24 mm	26-2284-30 T
35 x 24 mm	26-2284-35 T
40 x 24 mm	26-2284-40 T
45 x 24 mm	26-2284-45 T
50 x 24 mm	26-2284-50 T
55 x 24 mm	26-2284-55 T
60 x 24 mm	26-2284-60 T
65 x 24 mm	26-2284-65 T
70 x 24 mm	26-2284-70 T



Blätter, lateral / lateral blades, only, stainless steel

40 x 23 mm	26-2281-40
45 x 23 mm	26-2281-45
50 x 23 mm	26-2281-50
55 x 23 mm	26-2281-55
60 x 23 mm	26-2281-60

Blätter, lateral, TITAN / lateral blades, only, TITANIUM

25 x 24 mm	26-2281-25 T
30 x 24 mm	26-2281-30 T
35 x 24 mm	26-2281-35 T
40 x 24 mm	26-2281-40 T
45 x 24 mm	26-2281-45 T
50 x 24 mm	26-2281-50 T
55 x 24 mm	26-2281-55 T
60 x 24 mm	26-2281-60 T
65 x 24 mm	26-2281-65 T
70 x 24 mm	26-2281-70 T



Blätter stumpf / blunt blades, only, stainless steel

45 x 23 mm	26-2285-45
50 x 23 mm	26-2285-50
55 x 23 mm	26-2285-55
60 x 23 mm	26-2285-60
65 x 23 mm	26-2285-65

Blätter stumpf, TITAN / blunt blades, only, TITANIUM

30 x 24 mm	26-2285-30 T
35 x 24 mm	26-2285-35 T
40 x 24 mm	26-2285-40 T
45 x 24 mm	26-2285-45 T
50 x 24 mm	26-2285-50 T
55 x 24 mm	26-2285-55 T
60 x 24 mm	26-2285-60 T
65 x 24 mm	26-2285-65 T
70 x 24 mm	26-2285-70 T
75 x 24 mm	26-2285-75 T



Blätter stumpf / blunt blades, only, stainless steel

50 x 25 mm	26-2286-50
60 x 25 mm	26-2286-60

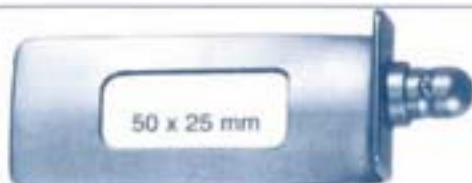

Wundspreizer für die Wirbelsäule
Retractors for spine

Caspar
Sperrer mit Haken (26-2287-138)
und 5 Blättern (26-2287-237 – 26-2287-257)
Retractor with hook (26-2287-138)
and 5 blades (26-2287-237 – 26-2287-257)

Artikel-Nummer
Cat. No.

26-2287-00



Sperrer, alleine / Retractor, only

26-2287-02



Haken / Hook 38 mm 26-2287-138
Haken / Hook 58 mm 26-2287-158

Blätter / blades

Blattlänge
Length of blades

Artikel-Nummer
Cat. No.

32 x 22 mm
37 x 22 mm
43 x 22 mm
47 x 22 mm
52 x 22 mm
57 x 22 mm
62 x 22 mm
67 x 22 mm

26-2287-232
26-2287-237
26-2287-243
26-2287-247
26-2287-252
26-2287-257
26-2287-262
26-2287-267



32 x 37 mm
37 x 37 mm
43 x 37 mm
47 x 37 mm
52 x 37 mm
57 x 37 mm
62 x 37 mm
67 x 37 mm

26-2287-332
26-2287-337
26-2287-343
26-2287-347
26-2287-352
26-2287-357
26-2287-362
26-2287-367



32 x 52 mm
37 x 52 mm
43 x 52 mm
47 x 52 mm
52 x 52 mm
57 x 52 mm
62 x 52 mm
67 x 52 mm

26-2287-432
26-2287-437
26-2287-443
26-2287-447
26-2287-452
26-2287-457
26-2287-462
26-2287-467



Wirbelkörper Distraktions System Vertebral body distraction system

	Artikel-Nummer Cat. No.
Caspar Distraktor alleine, rechts Distractor only, right	26-2288-00
Distraktor alleine, links Distractor only, left	26-2288-02
Distraktor alleine, rechts, mit verlängerter Führungsstange für mehrere Distraktionen Distractor only, right, with elongated toothed bar for multilevel distraction	26-2289-00
Distraktor alleine, links mit verlängerter Führungsstange für mehrere Distraktionen Distractor only, left with elongated toothed bar for multilevel distraction	26-2289-02
Bohrlehre, rechts, für Distraktor 26-2288-00 Drill guide, right, for distractor 26-2288-00	45-0001-00
Bohrlehre, links, für Distraktor 26-2288-02 Drill guide, left, for distractor 26-2288-02	45-0001-02



Bohrer 1,7 mm für Distraktionsschrauben Bohrtiefe 8 mm
 Twist drill 1,7 mm for distraction screws, drilling depth: 8 mm

Gesamtlänge
 Total length

Artikel-Nummer
 Cat. No.

145 mm

45-0001-04



Schraubendreher für Distraktions-Schrauben
 Screw driver for distraction

Gesamtlänge
 Total length

Artikel-Nummer
 Cat. No.

200 mm

45-0001-06



Distraktions-Schrauben auf Anfrage lieferbar
 Distraction screws available on request

Wirbelsäule



Blakesley gerade straight

	Schaft Länge shaft length	Maul Höhe jaw height	Breite width	Länge length	Art.-Nr. Cat. No.
Fig. 00000	120 mm	3,5 mm	1,7	8,0 mm	45-0398-00 N
Fig. 00000	120 mm	3,5 mm	1,7	14,0 mm	45-0398-14 N
Fig. 0000	120 mm	3,5 mm	2,0	8,0 mm	45-0399-00 N
Fig. 00	120 mm	4,0 mm	2,5	8,0 mm	45-0401-00 N
Fig. 0	120 mm	4,0 mm	3,0	10,0 mm	45-0402-00 N
Fig. 1	120 mm	4,5 mm	3,5	10,0 mm	45-0403-00 N
Fig. 2	120 mm	5,0 mm	4,0	14,0 mm	45-0404-00 N
Fig. 3	120 mm	5,0 mm	4,5	14,0 mm	45-0405-00 N
Fig. 4	120 mm	5,0 mm	6,0	15,0 mm	45-0406-00 N



Blakesley 45°

Fig. 00000	120 mm	3,5 mm	1,7	8,0 mm	45-0408-00 N
Fig. 0000	120 mm	3,5 mm	2,0	8,0 mm	45-0409-00 N
Fig. 00	120 mm	4,0 mm	2,5	8,0 mm	45-0411-00 N
Fig. 0	120 mm	4,0 mm	3,0	10,0 mm	45-0412-00 N
Fig. 1	120 mm	4,5 mm	3,5	10,0 mm	45-0413-00 N
Fig. 2	120 mm	4,5 mm	4,0	13,0 mm	45-0414-00 N
Fig. 3	120 mm	4,5 mm	4,5	14,0 mm	45-0415-00 N
Fig. 4	120 mm	5,0 mm	6,0	14,0 mm	45-0416-00 N



Blakesley gerade

Fig. 00000	170 mm	3,5 mm	1,7	8,0 mm	45-0388-00 N
Fig. 0000	170 mm	3,5 mm	2,0	8,0 mm	45-0389-00 N
Fig. 00	170 mm	4,0 mm	2,5	8,0 mm	45-0391-00 N
Fig. 0	170 mm	4,0 mm	3,0	10,0 mm	45-0392-00 N
Fig. 0	170 mm	4,0 mm	3,0	14,0 mm	45-0392-14 N
Fig. 1	170 mm	4,5 mm	3,5	10,0 mm	45-0393-00 N
Fig. 1	170 mm	4,5 mm	3,5	16,0 mm	45-0393-16 N
Fig. 2	170 mm	5,0 mm	4,0	14,0 mm	45-0394-00 N
Fig. 3	170 mm	5,0 mm	4,5	14,0 mm	45-0395-00 N
Fig. 4	170 mm	5,0 mm	6,0	15,0 mm	45-0396-00 N



Blakesley 45°

Fig. 00000	170 mm	3,5 mm	1,7	8,0 mm	45-0368-00 N
Fig. 0000	170 mm	3,5 mm	2,0	8,0 mm	45-0369-00 N
Fig. 00	170 mm	4,0 mm	2,5	8,0 mm	45-0371-00 N
Fig. 0	170 mm	4,0 mm	3,0	10,0 mm	45-0372-00 N
Fig. 1	170 mm	4,5 mm	3,5	10,0 mm	45-0373-00 N
Fig. 2	170 mm	4,5 mm	4,0	13,0 mm	45-0374-00 N
Fig. 3	170 mm	4,5 mm	4,5	14,0 mm	45-0375-00 N
Fig. 4	170 mm	5,0 mm	6,0	14,0 mm	45-0376-00 N



Stanzen Punches

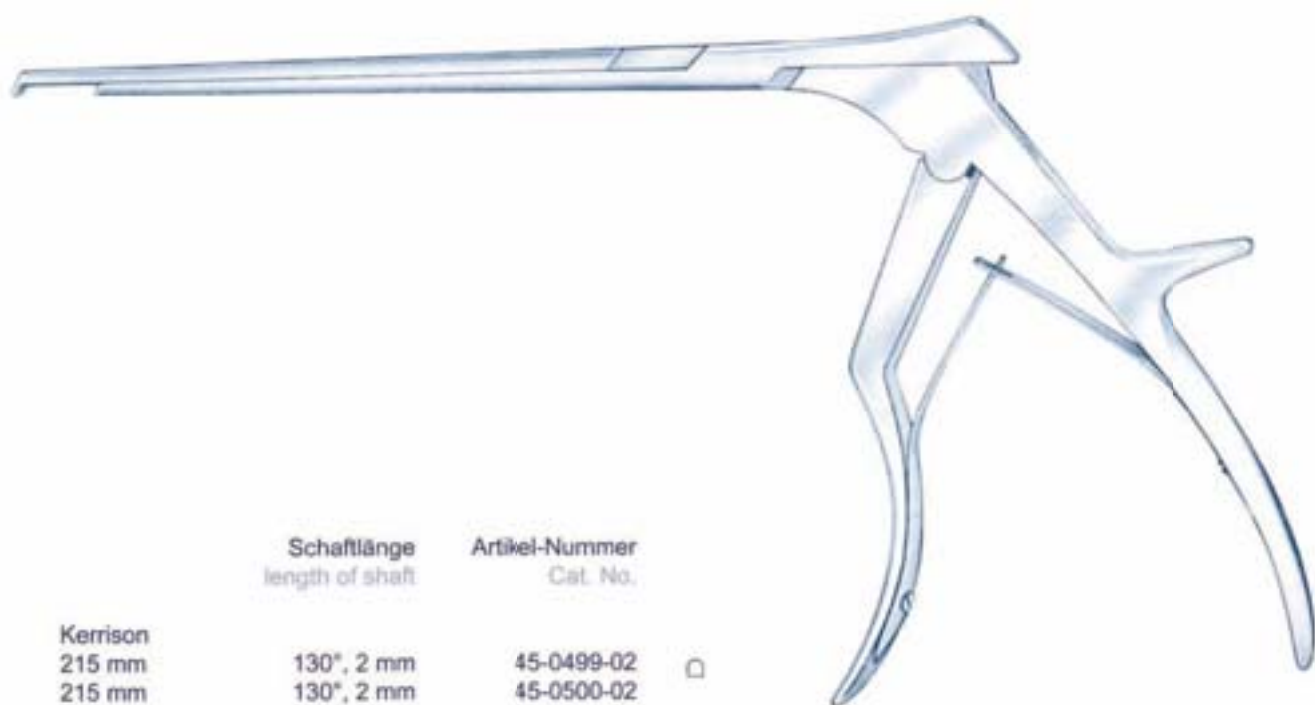

	Schaftlänge length of shaft	Artikel-Nummer Cat. No.	
Kerrison			
215 mm	130°, 2 mm	45-0499-02	□
215 mm	130°, 2 mm	45-0500-02	□
215 mm	130°, 3 mm	45-0499-03	□
215 mm	130°, 3 mm	45-0500-03	□
215 mm	130°, 4 mm	45-0499-04	□
215 mm	130°, 4 mm	45-0500-04	□
215 mm	130°, 5 mm	45-0499-05	□
215 mm	130°, 5 mm	45-0500-05	□

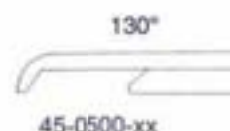
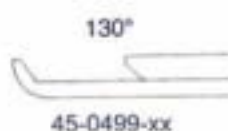

Knochenzangen mit dünner Fußplatte Bone Punches with thin footplate

175 mm	130°, 1 mm	45-0476-01	□
175 mm	130°, 1 mm	45-0478-01	□
175 mm	130°, 2 mm	45-0476-02	□
175 mm	130°, 2 mm	45-0478-02	□
175 mm	130°, 3 mm	45-0476-03	□
175 mm	130°, 3 mm	45-0478-03	□

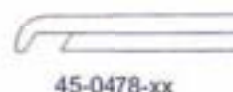
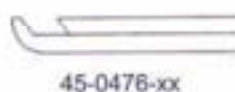

auf Wunsch nach Ferris-Smith-Cushing Zusatzbuchstabe "F"
When desired after Ferris Smith Cushing addition letter „F“

Hohlmeißelzangen
Bone rongeur

Luer gebogen / curved
150 x 3 mm 36-0772-03



Böhler übersetzt, gerade / double action, straight
180 x 2 mm 36-0779-02
180 x 2 mm 36-0780-02
180 x 3 mm 36-0780-03

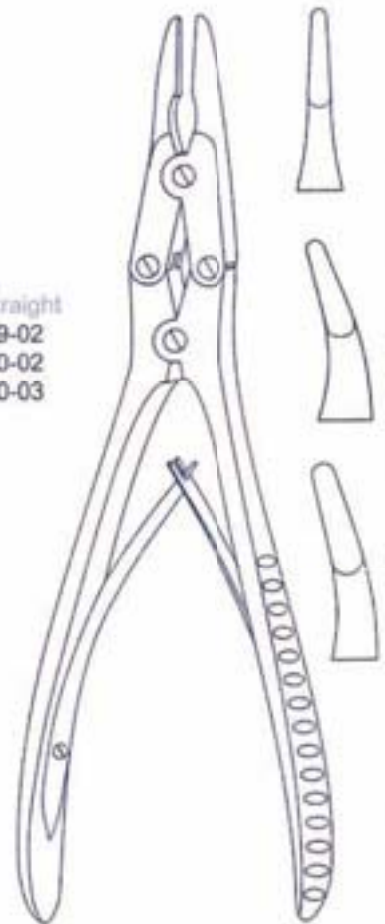

Stellbrink, gebogen / curved
170 x 2 mm 36-0782-02
Stellbrink, stark gebogen / strong curved
170 x 2 mm 36-0783-02

Hohlmeißelzangen
 Bone rongeur

Beyer übersetzt, gebogen / double action, curved
 180 x 3 mm 36-0810-03
 180 x 4 mm 36-0810-04

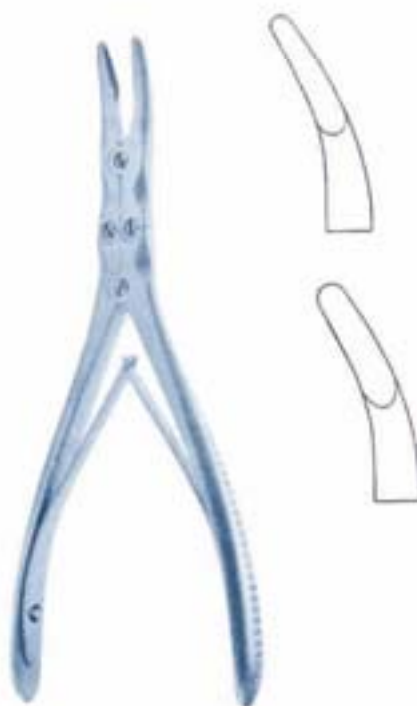

Ruskin übersetzt, gebogen / double action, curved
 190 x 4 mm 36-0812-04
 190 x 5 mm 36-0812-05
 210 x 8 mm 36-0818-08

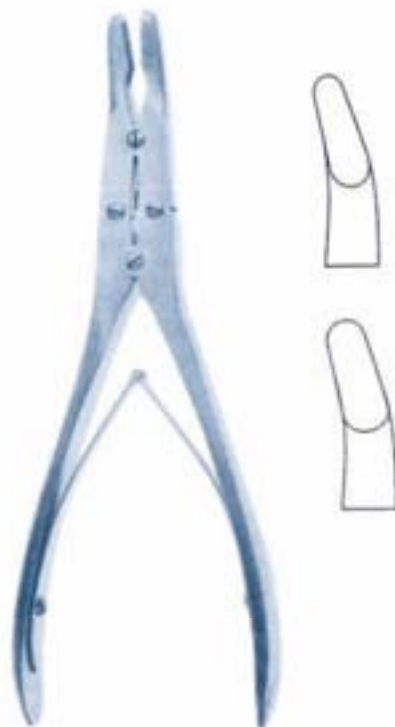

Hohlmeißelzangen Bone rongeur



Bayer, gebogen / curved
180 x 2 mm 36-0813-02



Lemper, gerade / straight
190 x 2 mm 36-0316-02
gebogen / curved
190 x 2 mm 36-0316-03



Kuhlendahl übersetzt, gebogen
double action, curved
180 x 3 mm 36-0826-03



Jansen übersetzt, gebogen
double action, curved
180 x 4 mm 36-0811-04



Hohlmeißelzangen

Bone rongeur

Leksell übersetzt, seitlich gebogen

Leksell double action, curved

210 x 3 mm

36-0850-03

210 x 5 mm

36-0850-05

mit extra flachem unteren Löffel

with extra flat lower spoon

210 x 6 mm

36-0850-06

210 x 8 mm

36-0850-08

Leksell übersetzt, seitlich stark gebogen

Leksell double action, strong curved

210 x 6 mm

36-0854-06

210 x 8 mm

36-0854-08

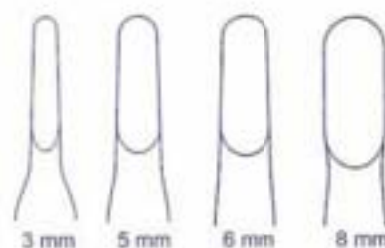

Echlin übersetzt, seitlich stark gebogen

Echlin double action, strong curved

210 x 2 mm

36-0862-02

210 x 3 mm

36-0862-03

210 x 4 mm

36-0862-04

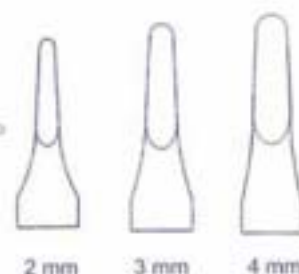

Hohlmeißelzangen Bone rongeur

Röttgen Ruskin übersetzt, gebogen
double action, curved
230 x 5 mm
230 x 6 mm

36-0819-05
36-0819-06

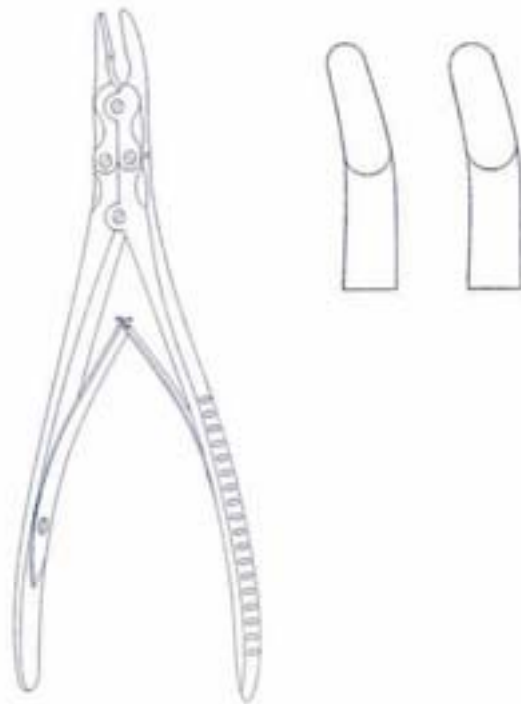

Allgemeines Instrumentarium
General Instruments



Klingenhalter / Scalpel handels
Skalpellklingen / Blades

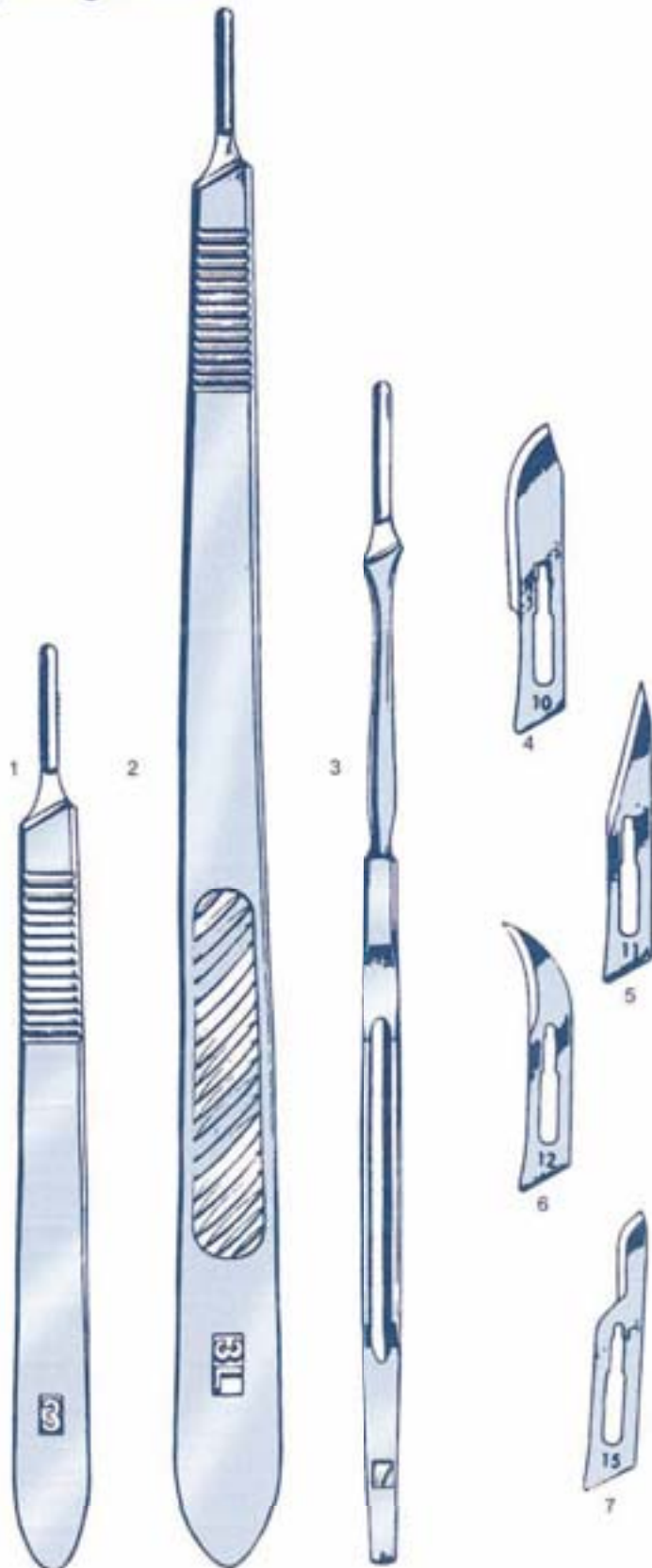

Klingenhalter
Scalpel handles

- | | |
|---|-------------|
| 1 | 12-0003-00 |
| 2 | 12-0003-00L |
| 3 | 12-0007-00 |

S-M Einweg-Skalpellklingen
S-M Single use scalpel blades

- | | |
|---|------------|
| 4 | 12-0010-00 |
| 5 | 12-0011-00 |
| 6 | 12-0012-00 |
| 7 | 12-0015-00 |

Einweg-Skalpelle
auf Anfrage
Single use scalpels
on request

Kanülen Canulas



Knopfkanülen mit Olive B und Schlaucholive
mit Schlauchansatz / Luer
Buttoncanula with olive B and tube-olive with tubing
attachment (Luer)

Artikel-Nr.
Cat. No.

1,5 x 80 mm gerade / straight 12-0837-00
1,5 x 80 mm gebogen / curved 12-0837-05



Knopfkanülen mit Olive B und Luer-Lock-Ansatz
Buttoncanula with olive B and Luer-Lock-attachment

Artikel-Nr.
Cat. No.

gerade / straight 12-0838-00
gebogen / curved 12-0838-05



Cushing Ventrikel-Kanüle mit Mandrin
Ventricular needle with mandrin

Artikel-Nr.
Cat. No.
12-1280-00



Pinzetten
Forceps

Anatomische Pinzetten
Anatomical Forceps

Gerald, 175 mm
Taylor, 175 mm

Artikel-Nr.
Cat. No.

13-0200-00
13-0217-00



Bajonettpinzette
Forceps bajonet type
fein, Maul / fine, jaw
1,0 mm, 190 mm
mittel, Maul / medium, jaw
1,5 mm, 190 mm

13-9638-00
13-9639-00



Chirurgische Pinzetten
Surgical forceps

Gerald, 175 mm
Taylor, 175 mm

14-0200-00
14-0217-00



Anatomische Pinzetten mit Hartmetalleinlagen Anatomical forceps with tungsten carbide insert

Potts-Smith

Maulbreite jaw width	Gesamtlänge total length	Artikel-Nr. Cat. No.
1,8 mm	170 mm	13-9739-17

Lucae

bajonettförmig / bayonet-shaped

Maulbreite jaw width	Gesamtlänge total length	Artikel-Nr. Cat. No.
1,8 mm	180 mm	13-9740-18

Potts-Nevins

Maulbreite jaw width	Gesamtlänge total length	Artikel-Nr. Cat. No.
1,8 mm	140 mm	13-9772-14
	170 mm	13-9772-17
	200 mm	13-9772-20
	250 mm	13-9772-25

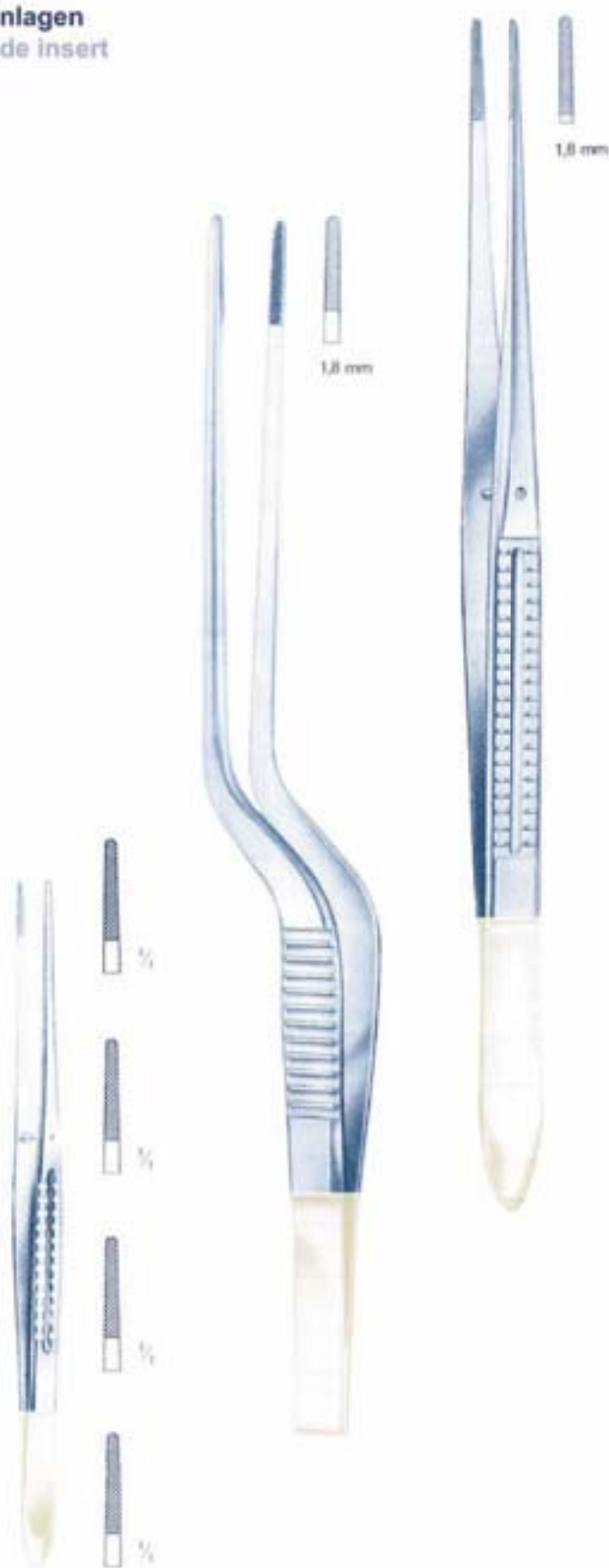

Scheren mit Turmspitze
Scissors with towerpoint

gerade / straight
115 mm
gebogen / curved
115 mm

Artikel-Nr.
Cat. No.

15-0120-12

15-0121-12

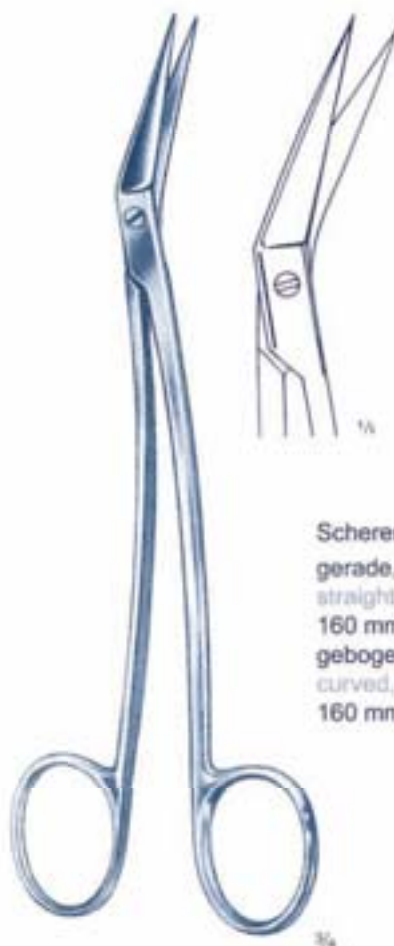
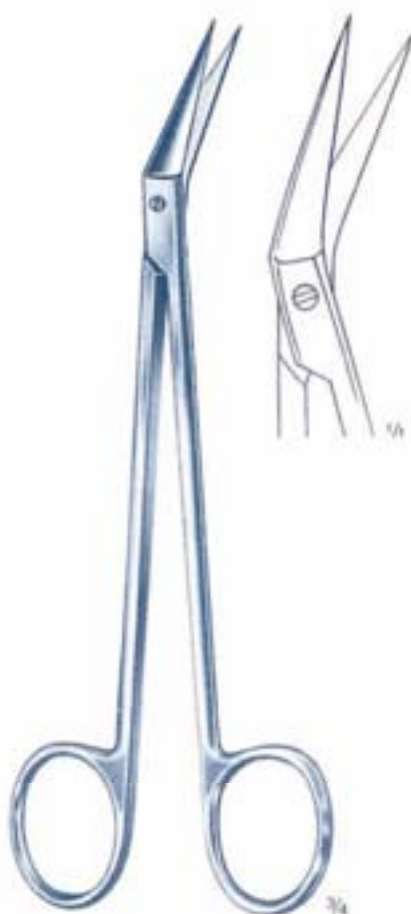

Scheren nach Locklin / Scissors acc. Locklin

gerade, Schneide abgewinkelt
straight, blade down angled

160 mm

15-0153-16

gebogen, Schneide abgewinkelt
curved, blade down angled

160 mm

15-0154-16

Scheren Scissors

Metzenbaum

	Artikel-Nr. Cat. No.		Artikel-Nr. Cat. No.
stumpf-stumpf / blunt-blunt		stumpf-stumpf / blunt-blunt	
gerade / straight		gerade / straight	
145 mm,	15-0181-15	180 mm	15-0181-18
gebogen / curved		gebogen / curved	
145 mm	15-0182-15	180 mm	15-0182-18
spitz-stumpf / sharp-blunt		gerade / straight	
gerade / straight		200 mm	15-0181-20
145 mm,	15-0179-15	gebogen / curved	
gebogen / curved		200 mm	15-0182-20
145 mm	15-0180-15	gerade / straight	
		230 mm	15-0181-23
		gebogen / curved	
		230 mm	15-0182-23

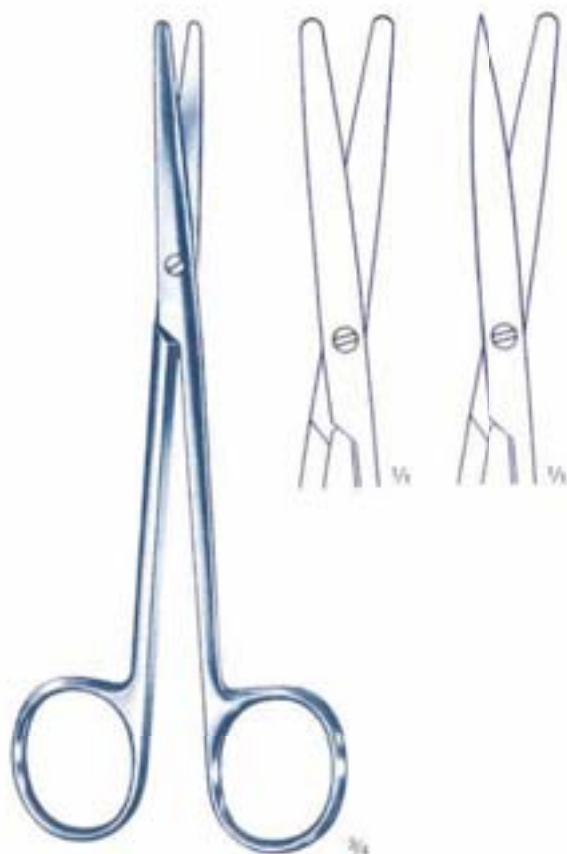

Scheren
Scissors

Metzenbaum fino

	Artikel-Nr. Cat. No.		Artikel-Nr. Cat. No.
stumpf-stumpf / blunt-blunt gerade / straight 145 mm,	15-0183-15	stumpf-stumpf / blunt-blunt gerade / straight 180 mm	15-0183-18
gebogen / curved 145 mm	15-0184-15	gebogen / curved 180 mm	15-0184-18
spitz-stumpf / sharp-blunt gerade / straight 145 mm,	15-0177-15	gerade / straight 200 mm	15-0183-20
gebogen / curved 145 mm	15-0178-15	gebogen / curved 200 mm	15-0184-20
		gerade / straight 230 mm	15-0183-23
		gebogen / curved 230 mm	15-0184-23

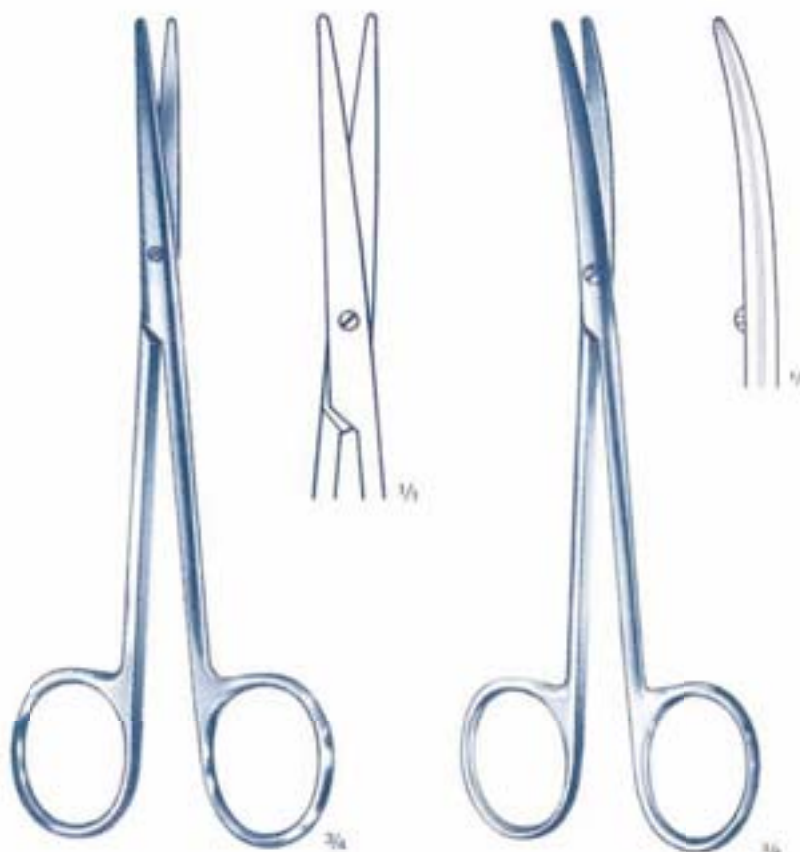

Scheren Scissors

Metzenbaum S-förmig
Metzenbaum S-shaped

Artikel-Nr.
Cat. No

stumpf-stumpf / blunt-blunt

gerade / straight

180 mm

15-0187-18

gebogen / curved

180 mm

15-0188-18

gerade / straight

200 mm

15-0187-20

gebogen / curved

200 mm

15-0188-20

gerade / straight

230 mm

15-0187-23

gebogen / curved

230 mm

15-0188-23



Scheren
Scissors

Scheren nach Lexer
Scissors acc. Lexer

gebogen / curved
stumpf-stumpf / blunt-blunt
160 mm

Artikel-Nr.
Cat. No.

15-0265-16

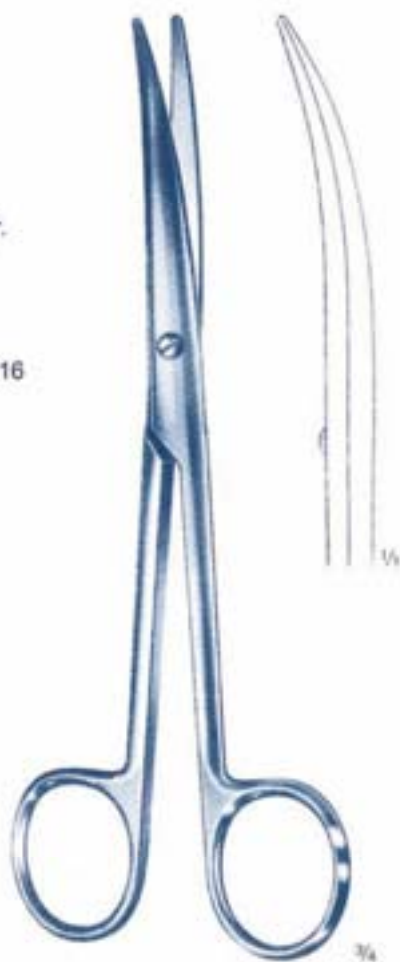

Scheren nach Tönnis-Adson
Scissors acc. Tönnis-Adson

gebogen / curved
stumpf-stumpf / blunt-blunt
170 mm

Artikel-Nr.
Cat. No.

15-0295-17

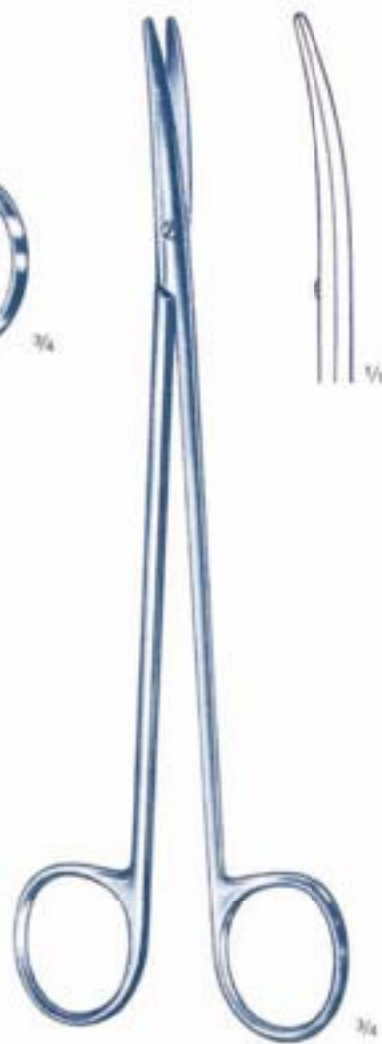

Scheren Scissors

Diethrich

Artikel-Nr.
Cat. No.

abgewinkelt / down angled
spitz-spitz / pointed-pointed

25°, 180 mm
45°, 180 mm
60°, 180 mm
90°, 180 mm
125°, 180 mm

15-0390-18
15-0391-18
15-0392-18
15-0393-18
15-0394-18

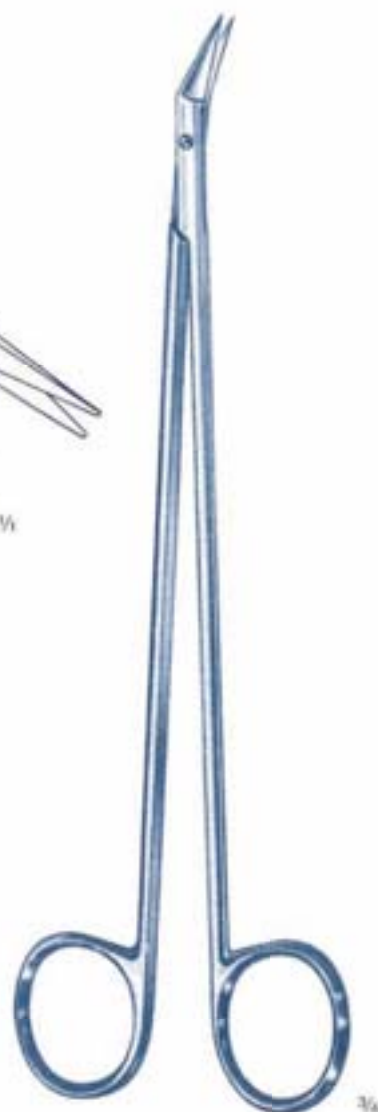
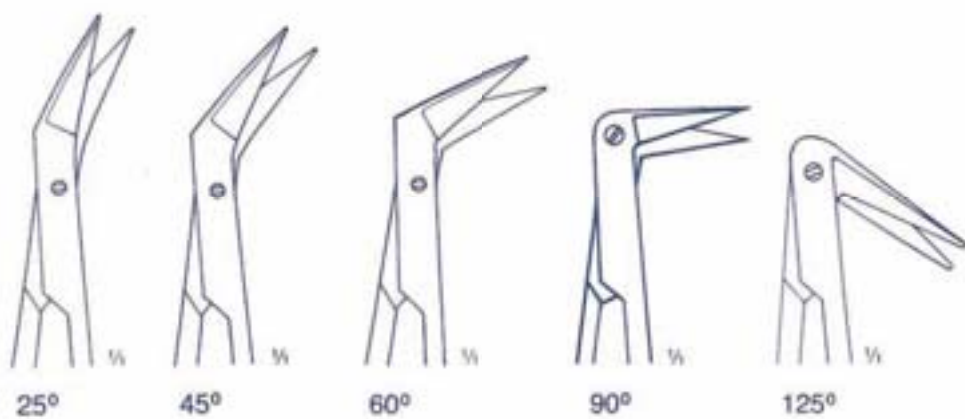

3/4

Scheren
Scissors

Diethrich fino

Artikel-Nr.
Cat. No.

abgewinkelt / down angled
spitz-spitz / pointed-pointed

25°, 180 mm
45°, 180 mm
60°, 180 mm
90°, 180 mm
125°, 180 mm

15-0397-18
15-0398-18
15-0399-18
15-0400-18
15-0401-18

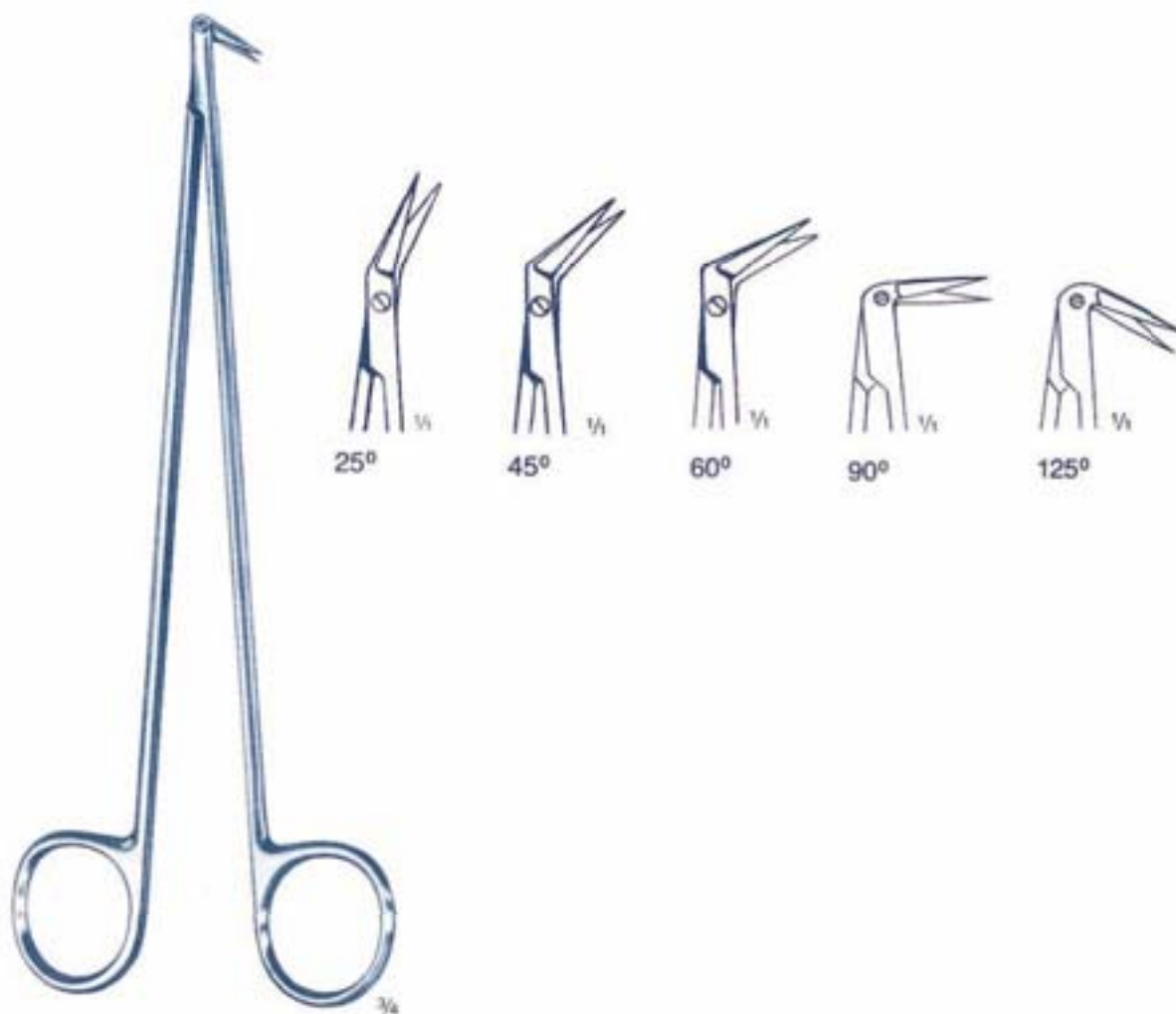

Scheren Scissors

Alle Standardscheren sind auch mit hochwertigem Mikroschliff erhältlich, sie erhalten bei der Bestellung, den Zusatz „M“ zur Artikel Nummer.

All standard scissors are also available with high-quality microsection. They receive the addition „M“ with the order to the article number.

Gefäßscheren nach Falvaloro
Vascular scissors acc. Falvaloro

Artikel-Nr.
Cat. No.

Schneide abgewinkelt, Schaft gebogen
cut down angled, shank curved

170 mm
230 mm

15-0238-17
15-0238-23



Gefäßschere nach Coronary
Vascular scissors acc. Coronary

Artikel-Nr.
Cat. No.

Schneide und Schaft abgewinkelt
Cut and shank down angled
170 mm

15-0239-17

Scheren
Scissors

Scheren nach Locklin mit Hartmetalleinlage
Scissors acc. Locklin with tungsten carbide insert

Artikel-Nr.
Cat. No.

gerade, Schneide abgewinkelt
straight, blade down angled

160 mm

15-2153-16

gebogen, Schneide abgewinkelt
curved, blade down angled

160 mm

15-2154-16

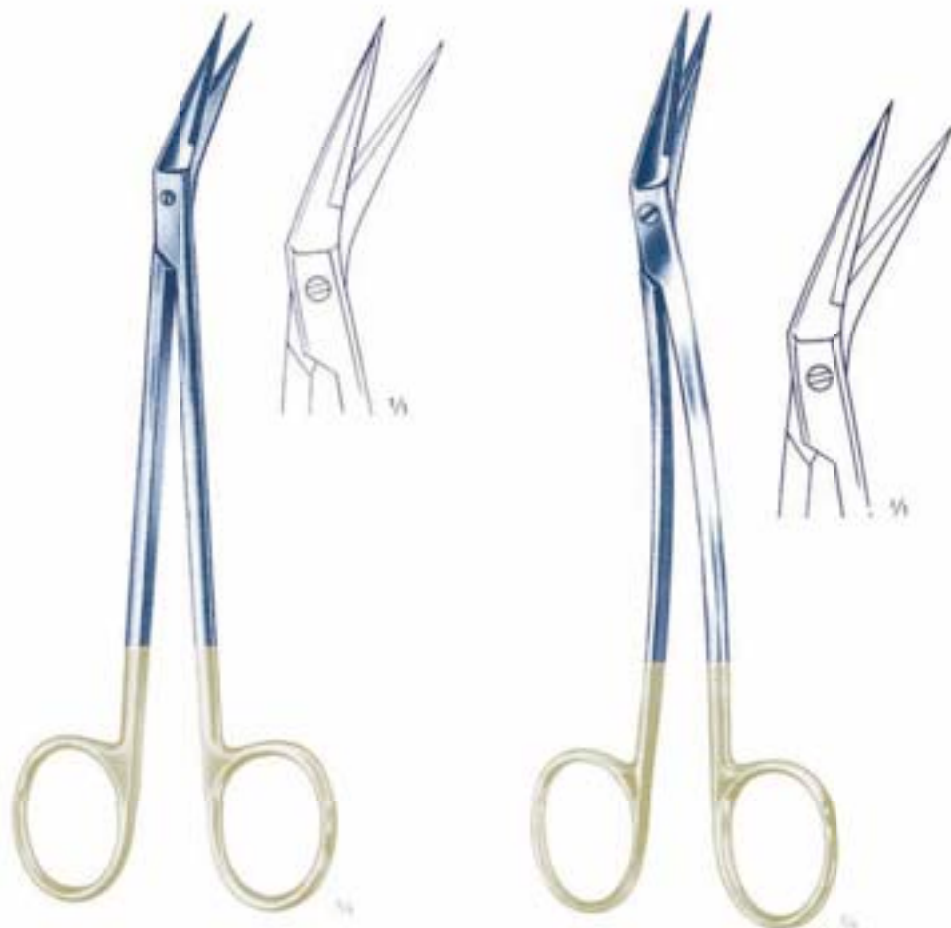

Scheren Scissors

Scheren nach Metzenbaum mit Hartmetalleinlage
Scissors acc. Metzenbaum with tungsten carbide insert

	Artikel-Nr. Cat. No.
stumpf-stumpf / blunt-blunt	
gerade / straight	
145 mm	15-2181-15
gebogen / curved	
145 mm	15-2182-15
spitz-stumpf / sharp-blunt	
gerade / straight	
145 mm	15-2179-15
gebogen / curved	
145 mm	15-2180-15



Scheren
Scissors

Scheren nach Metzenbaum mit Hartmetalleinlage
Scissors acc. Metzenbaum with tungsten carbide insert

	Artikel-Nr. Cat. No.
stumpf-stumpf / blunt-blunt	
gerade / straight	
180 mm	15-2181-18
gebogen / curved	
180 mm	15-2182-18
gerade / straight	
200 mm	15-2181-20
gebogen / curved	
200 mm	15-2182-20
gerade / straight	
230 mm	15-2181-23
gebogen / curved	
230 mm	15-2182-23



Scheren Scissors

Scheren nach Metzenbaum fino mit Hartmetalleinlage
Scissors acc. Metzenbaum fino with tungsten carbide insert

	Artikel-Nr. Cat. No.
stumpf-stumpf / blunt-blunt gerade / straight 145 mm	15-2183-15
gebogen / curved 145 mm	15-2184-15
spitz-stumpf / sharp-blunt gerade / straight 145 mm	15-2177-15
gebogen / curved 145 mm	15-2178-15
stumpf-stumpf / blunt-blunt gerade / straight 180 mm	15-2183-18
gebogen / curved 180 mm	15-2184-18
gerade / straight 200 mm	15-2183-20
gebogen / curved 200 mm	15-2184-20
gerade / straight 230 mm	15-2183-23
gebogen / curved 230 mm	15-2184-23



Scheren
Scissors

Scheren nach Metzenbaum S-förmig mit Hartmetall
Scissors acc. Metzenbaum S-shaped with tungsten carbide insert

	Artikel-Nr. Cat. No.
stumpf-stumpf / blunt-blunt	
gerade / straight	
180 mm	15-2187-18
gebogen / curved	
180 mm	15-2188-18
gerade / straight	
200 mm	15-2187-20
gebogen / curved	
200 mm	15-2188-20
gerade / straight	
230 mm	15-2187-23
gebogen / curved	
230 mm	15-2188-23



Scheren nach Tönnis-Adson mit Hartmetalleinlage
Scissors acc. Toennis-Adson with tungsten carbide insert

stumpf-stumpf / blunt-blunt	
gebogen / curved	
170 mm	15-2296-17

Scheren Scissors

Scheren nach Metzenbaum SUPERCUT Scissors acc. Metzenbaum SUPERCUT

	Artikel-Nr. Cat. No.
stumpf-stumpf / blunt-blunt	
gerade / straight	
145 mm	15-4181-15
gebogen / curved	
145 mm	15-4182-15
spitz-stumpf / sharp-blunt	
gerade / straight	
145 mm	15-4179-15
gebogen / curved	
145 mm	15-4180-15
stumpf-stumpf / blunt-blunt	
gerade / straight	
180 mm	15-4181-18
gebogen / curved	
180 mm	15-4182-18
gerade / straight	
200 mm	15-4181-20
gebogen / curved	
200 mm	15-4182-20
gerade / straight	
230 mm	15-4181-23
gebogen / curved	
230 mm	15-4182-23



Scheren
 Scissors

Scheren nach Metzenbaum fino SUPERCUT
 Scissors acc. Metzenbaum fino SUPERCUT

	Artikel-Nr. Cat. No.
stumpf-stumpf / blunt-blunt gerade / straight 145 mm	15-4183-15
gebogen / curved 145 mm	15-4184-15
spitz-stumpf / sharp-blunt gerade / straight 145 mm	15-4177-15
gebogen / curved 145 mm	15-4178-15
stumpf-stumpf / blunt-blunt gerade / straight 180 mm	15-4183-18
gebogen / curved 180 mm	15-4184-18
gerade / straight 200 mm	15-4183-20
gebogen / curved 200 mm	15-4184-20
gerade / straight 230 mm	15-4183-23
gebogen / curved 230 mm	15-4184-23



























Ein Wellenschliff verhindert das Ausgleiten des zu schneidenden Material ohne die Schneidfähigkeit zu reduzieren oder die Schnittfähigkeit zu beeinträchtigen. Die Teilung des Wellenschliffs beträgt 0,33 mm. Alle Scheren können mit einem Wellenschliff versehen werden. Sie erhalten bei der Bestellung, den Zusatz „W“ zur Artikel Nummer.







A wave cross section prevents the output leading of material, which can be cut, without reducing cut ability or impairing cut durability. The division of the wave cross section amounts to 0.33 mm. All scissors can be provided with wave cross section. They receive the addition „W“ with the order to the article number.

Allgemeines Instrumentarium

Gefäßklemmen, Bulldogklemmen Vessel clamps, Bulldog clamps

	Gesamtlänge Total length	Artikel-Nummer Cat. No.			
					17-0040-40 - 17-0043-45
De Bakey	40 mm	17-0040-40			
	40 mm	17-0041-40			
	45 mm	17-0040-45			
	45 mm	17-0041-45			
	40 mm	17-0042-40			
	45 mm	17-0043-45			
De Bakey	50 mm	17-0010-50 (17-1010-10)			
(Atraumatisch / Atraumatic)	50 mm	17-0011-50			17-0010-50 17-0011-50
					17-0013-57
Glover	57 mm	17-0013-57			
De Bakey	73 mm	17-0015-73			
					17-0015-73

Gefäßklemmen, Bulldogklemmen
Vessel clamps, Bulldog clamps

	Gesamtlänge Total length	Maullänge Length of jaw	Artikel-Nummer Cat. No.		
De Bakey <small>(Atraumatisch / atraumatic)</small>	80 mm	25 mm	17-0060-25		
	90 mm	35 mm	17-0060-35		
	105 mm	50 mm	17-0060-50		
	124 mm	68 mm	17-0060-68		
De Bakey <small>(Atraumatisch / atraumatic)</small>	78 mm	25 mm	17-0061-25		1/1
	86 mm	35 mm	17-0061-35		
	97 mm	50 mm	17-0061-50		
	114 mm	68 mm	17-0061-68		
Glover <small>(Atraumatisch / atraumatic)</small>	68 mm	33 mm	17-0016-33		
	96 mm	50 mm	17-0016-50		
	117 mm	69 mm	17-0016-69		
Glover <small>(Atraumatisch / atraumatic)</small>	65 mm	33 mm	17-0017-33		1/1
	91 mm	50 mm	17-0017-50		
	110 mm	69 mm	17-0017-69		

Wundhäkchen Retractor



Tracheal - Häkchen
tracheal retractor
17 cm

scharf / sharp
enge Biegung / narrow bend

1 Haken / hook	24-0031-00
2 Haken / hooks	24-0032-00
3 Haken / hooks	24-0033-00
4 Haken / hooks	24-0034-00



Tracheal - Häkchen
tracheal retractor
17 cm

halbscharf / semi sharp
enge Biegung / narrow bend

Haken / hook	24-0001-00
2 Haken / hooks	24-0002-00
3 Haken / hooks	24-0003-00
4 Haken / hooks	24-0004-00



Wundhäkchen / Retractors

eng, scharf, flexibel / narrow, sharp, flexibel		
2 Haken / hooks	3 Haken / hooks	4 Haken / hooks
24-0072-00	24-0073-00	24-0074-00

eng, stumpf, flexibel / narrow, blunt, flexibel		
2 Haken / hooks	3 Haken / hooks	4 Haken / hooks
24-0082-00	24-0083-00	24-0084-00



Wundhäkchen
Retractor

Strendell-Stille

170 mm 24-0070-00
170 mm gezahnt / perforated 24-0071-00

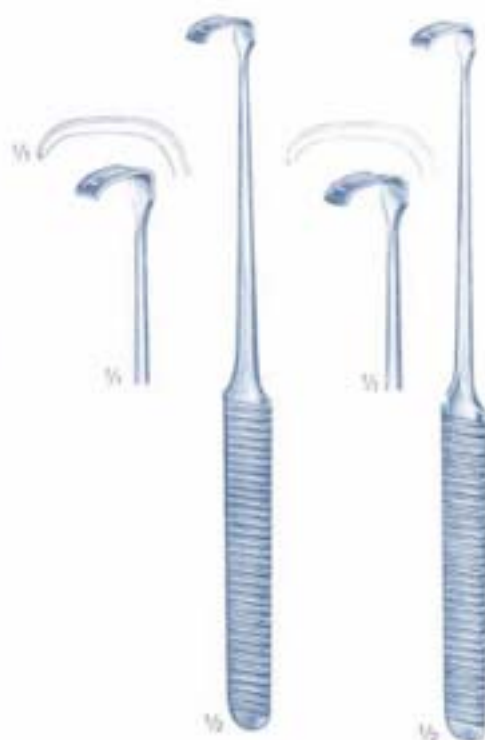

Volkmann

halbscharf, mit Ringgriff, 215 mm / semi-sharp, with Ring-grip

2 Haken / hooks	3 Haken / hooks	4 Haken / hooks	6 Haken / hooks
24-0142-00	24-0143-00	24-0144-00	24-0146-00

halbscharf, mit Ringgriff, 215 mm / semi-sharp, ring handle

2 Haken / hooks	3 Haken / hooks	4 Haken / hooks	6 Haken / hooks
Ringgriff 24-0122-00	24-0123-00	24-0124-00	24-0126-00
Hohlheft 24-0142-00	24-0143-00	24-0144-00	24-0146-00

scharf, mit Ringgriff, 215 mm / sharp, with Ring-grip

2 Haken / hooks	3 Haken / hooks	4 Haken / hooks	6 Haken / hooks
24-0102-00	24-0103-00	24-0104-00	24-0106-00

stumpf, mit Ringgriff, 215 mm / blunt, with Ring-grip

2 Haken / hooks	3 Haken / hooks	4 Haken / hooks	6 Haken / hooks
24-0112-00	24-0113-00	24-0114-00	24-0116-00

Wundhäkchen Retractor

Langenbeck

stumpf, mit Ringgriff, 210 mm

Blatt

22 x 6 mm	24-0159-00
35 x 7 mm	24-0160-00
30 x 10 mm	24-0161-00
30 x 14 mm	24-0162-00
30 x 16 mm	24-0163-00
33 x 14 mm	24-0164-00
40 x 10 mm	24-0166-00
43 x 13 mm	24-0167-00

Langenbeck

stumpf, mit Ringgriff, 210 mm

Blatt

55 x 20 mm	24-0182-00
63 x 20 mm	24-0183-00

Blatt

85 x 15 mm	24-0186-00
------------	------------



Wundhäkchen
Retractor

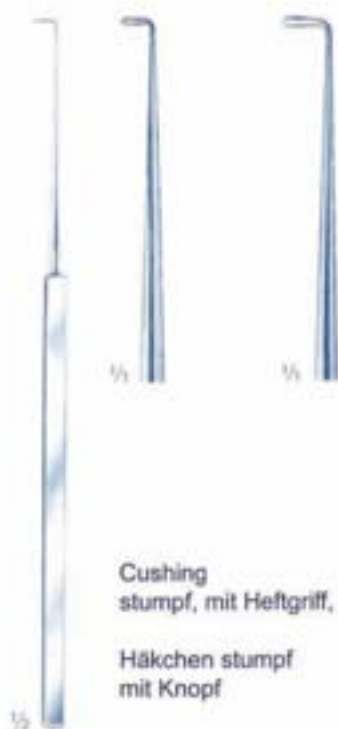

Cushing
stumpf, mit Heftgriff, 190 mm

Häkchen stumpf
mit Knopf 24-0260-00
 24-0262-00

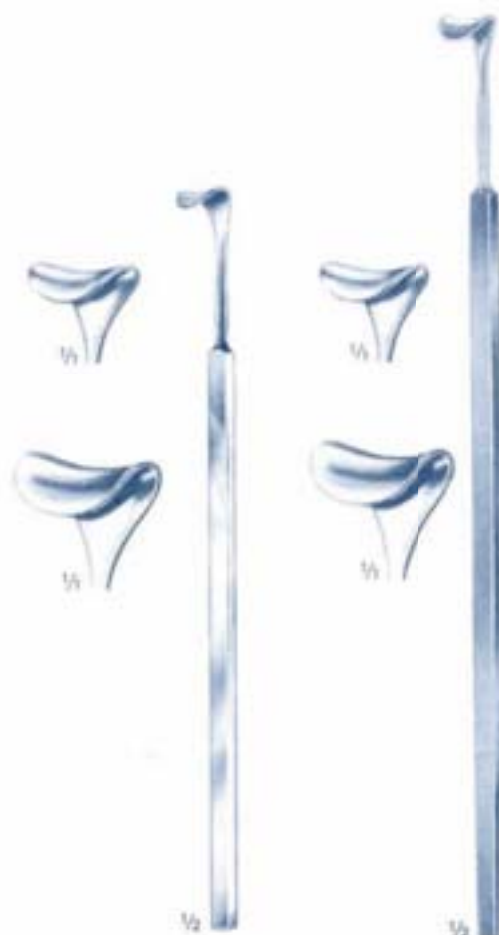

Cushing
stumpf, mit Heftgriff, 200 mm

Blatt
11 x 14 mm 24-0264-20
13 x 18 mm 24-0265-20

Cushing
stumpf, mit Heftgriff, 240 mm

Blatt
11 x 14 mm 24-0264-24
13 x 18 mm 24-0265-24



Weitlaner
Zähne

	Gesamtlänge	scharf	stumpf	halbscharf
3:4	105 mm	26-1170-00	26-1171-00	26-1171-04
3:4	135 mm	26-1172-00	26-1173-00	26-1172-04
3:4	165 mm	26-1174-00	26-1175-00	26-1174-04
3:4	200 mm	26-1176-00	26-1177-00	26-1176-04
5:6	260 mm	26-1180-00	26-1181-00	26-1180-04

Saugrohre Suction tubes

mit abgeflachter Spitze / flat tip
Gesamtlänge / total length 150 mm
biegsam / flexible

Durchmesser / diameter

2,0 mm	29-0359-02
3,0 mm	29-0359-03
4,0 mm	29-0359-04
5,0 mm	29-0359-05

mit abgeflachter Spitze / flat tip

Gesamtlänge / total length 180 mm
biegsam / flexible

Durchmesser / diameter

2,0 mm	29-0362-02
3,0 mm	29-0362-03
4,0 mm	29-0362-04
5,0 mm	29-0362-05

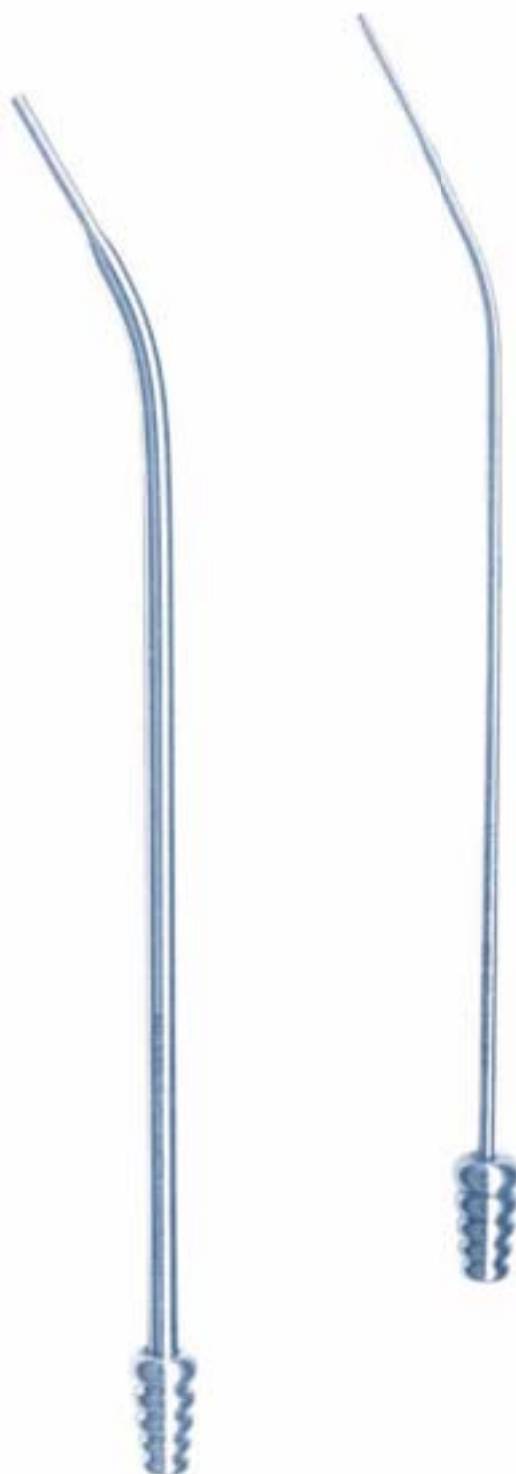

Nadelhalter mit Hartmetalleinlagen
Needle Holders with Tungsten Carbide Inserts

Profilie

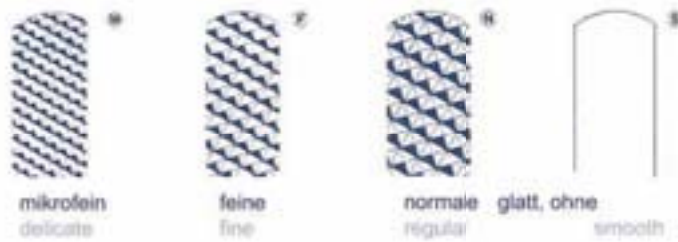

Derf

Einlage / insert (F), 130 mm 32-0100-00
 Einlage / insert (S), 130 mm 32-0102-00

Crile

Einlage / insert (F), 150 mm 32-0150-00

DeBakey

Einlage / insert (F), 180 mm 32-0152-00
 Einlage / insert (F), 260 mm 32-0156-00
 Einlage / insert (F), 300 mm 32-0158-00

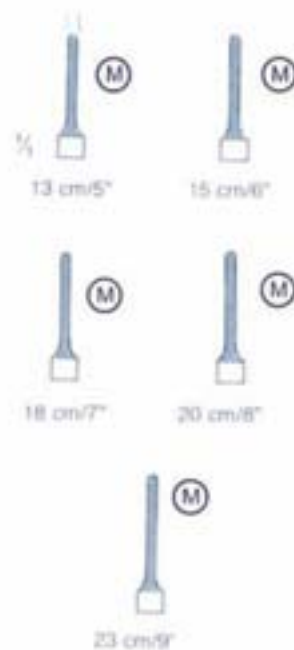

Mikro-Modell Ryder

Einlage / insert (M), 130 mm 32-0313-00
 Einlage / insert (M), 150 mm 32-0315-00
 Einlage / insert (M), 180 mm 32-0318-00
 Einlage / insert (M), 200 mm 32-0320-00
 Einlage / insert (M), 230 mm 32-0323-00

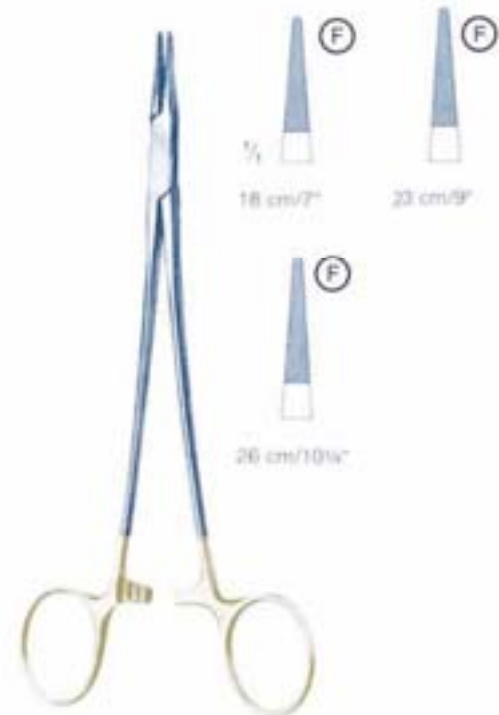

Allgemeines Instrumentarium

Nadelhalter mit Hartmetalleinlagen

Needle Holders with Tungsten Carbide Inserts

Mathieu
mit Innensperre
with ratchet inside

Einlage / Insert (N), 170 mm 32-0208-00

Einlage / Insert (N), 200 mm 32-0210-00

Einlage / Insert (F), 230 mm 32-0212-00



Zweifel

Einlage / Insert (N), 200 mm 32-6407-00

Einlage / Insert (F), 230 mm 32-6408-00



Tönnis, Einlage / Insert (F), 190 mm

32-6395-00

Hohlmeißelzangen
Bone rongeur

Luer gebogen / curved
150 x 3 mm 36-0772-03



Böhler
übersetzt, gerade / double action, straight 180 x 2 mm 36-0779-02
übersetzt, gebogen / double action, curved 180 x 2 mm 36-0780-02
übersetzt, gebogen / double action, curved 180 x 3 mm 36-0780-03

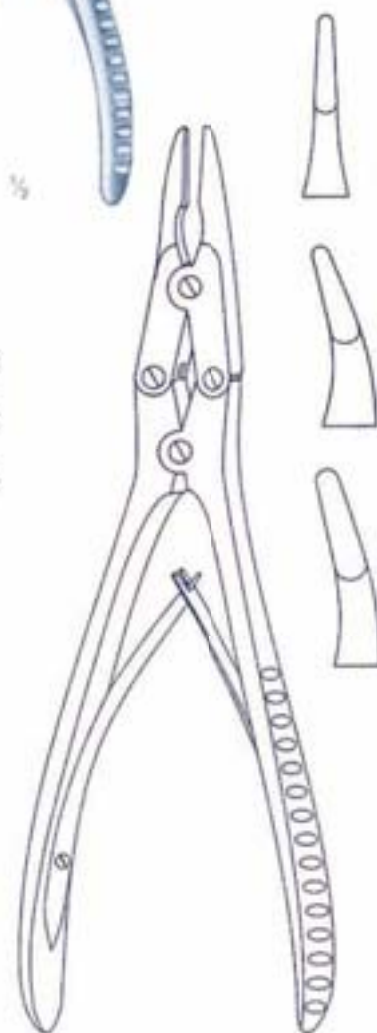
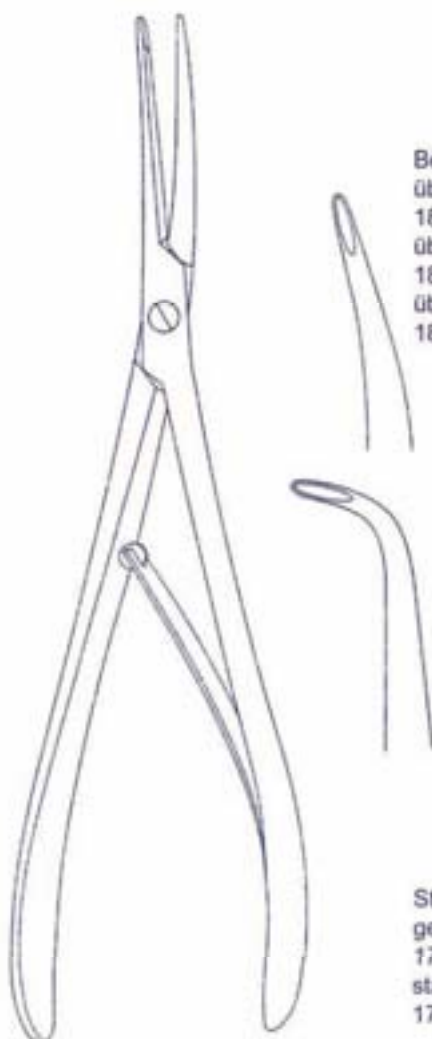

Stellbrink
gebogen / curved 170 x 2 mm 36-0782-02
stark gebogen / strong curved 170 x 2 mm 36-0783-02

Hohlmeißelzangen Bone rongeur

Beyer übersetzt, gebogen / double action, curved
180 x 3 mm 36-0810-03
180 x 4 mm 36-0810-04

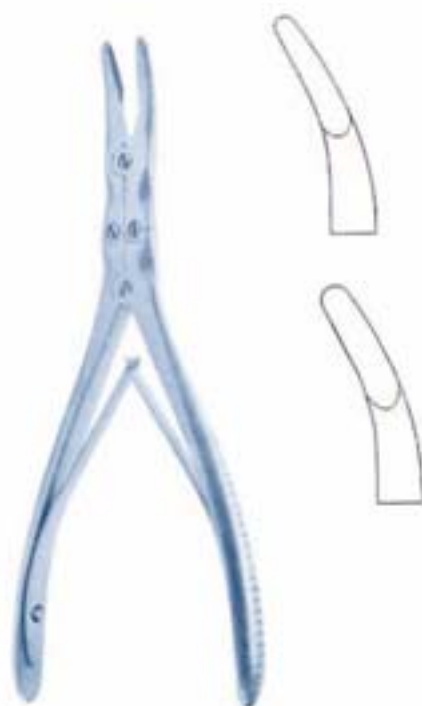

Ruskin übersetzt, gebogen / double action, curved
190 x 4 mm 36-0812-04
190 x 5 mm 36-0812-05



Hohlmeißelzangen
Bone rongeur



Beyer, gebogen / curved
180 x 2 mm 35-0813-02



Lemper, gerade / straight
190 x 2 mm 36-0816-02
Lemper, gebogen / curved
190 x 2 mm 36-0816-03



Kuhlendahl übersetzt, gebogen
double action, curved
180 x 3 mm 36-0826-03



Jansen übersetzt, gebogen
double action, curved
180 x 4 mm 36-0811-04

Hohlmeißelzangen
Bone rongeur

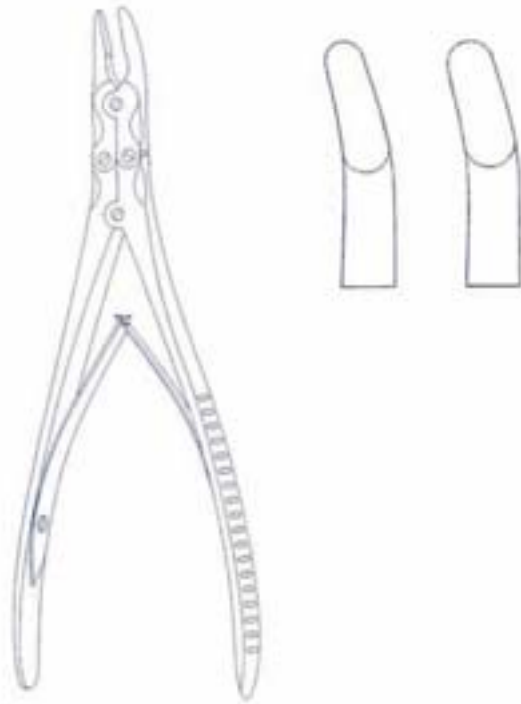

Röttgen Raskin übersetzt, gebogen,
double action, curved

230 x 5 mm
230 x 6 mm

36-0819-05
36-0819-06

Dissektoren
Dissectors

Röttgen, 230 mm
45-7001-00



Tönnis, 245 mm
45-7003-00



Kuhlendahl, 240 mm
45-7005-00



Davis, 230 mm
45-7002-00



Tönnis, 240 mm
45-7009-00



Mikro-Federscheren
Micro Scissors



Mikro-Federscheren, bajonettförmig, mit Lochgriff
Micro Scissors / Spring Type, bajonet-shaped

Länge
length

Artikel-Nr.
product.-no.

Nagel, 45° spitz-spitz,
sharp-sharp

200 mm

55-0387-20



45° spitz-knopf,
probe-pointed blade

200 mm

55-0388-20



125° spitz-spitz,
sharp-sharp

119 mm

55-0389-19



Mikro-Nadelhalter Micro-Needle Holders

Mikro-Nadelhalter, bajonettförmig, mit Lochgriff
Micro-Needle Holders, bayonet-shaped

Yasargil







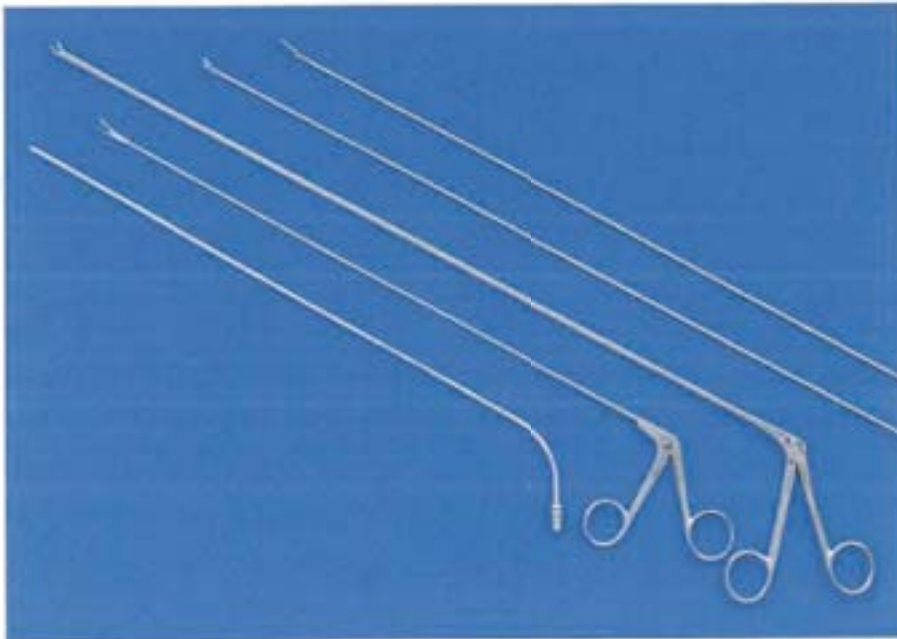





	Länge length	Artikel-Nr. product.-no.
gerade / straight	200 mm	55-0396-20
	230 mm	55-0396-23
gebogen / curved	165 mm	55-0397-17
	200 mm	55-0397-20
	225 mm	55-0397-22
	245 mm	55-0397-25



Broncho-Ösophaguskopie
Bronchooesophagoscopy

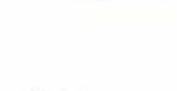

Broncho-Ösophagoskopiezangen Bronchoesophagocopy-forceps

Nutzlänge usable length	250 mm	350 mm	Nutzlänge usable length	450 mm	550 mm
	73-0710-25	73-0710-35		73-0862-45	73-0862-55
gerade / straight			gerade / straight		
	73-0730-25	73-0730-35		73-0864-45	73-0864-55
gerade / straight			gerade / straight		
	73-0732-25	73-0732-35		73-0866-45	73-0866-55
gerade / straight			gerade / straight		
	73-0790-25	73-0790-35		73-0876-45	73-0876-55
gerade / straight			gerade / straight		
	73-0792-25	73-0792-35		73-0878-45	73-0878-55
aufgebogen, 3,0 mm / upward curved			aufgebogen, 4,0 mm / upward curved		
	73-0793-25	73-0793-35		73-0879-45	73-0879-55
horizontal aufgebogen, 3,0 mm / horizontal upward curved			horizontal aufgebogen, 4,0 mm / horizontal upward curved		
	73-0794-25	73-0794-35		73-0882-45	73-0882-55
rechts / right, 3,0 mm			rechts, 4,0 mm / right		
	73-0796-25	73-0796-35		73-0884-45	73-0884-55
links / left, 3,0 mm			links, 4,0 mm / left		
	73-0812-25	73-0812-35		73-0890-45	73-0890-55
gerade, oval, 2,0 mm / straight, oval			oval, 3,0 mm / oval		
	73-0814-25	73-0814-35		73-0892-45	73-0892-55
gerade, oval 3 x 5 mm / straight, oval			gerade, 4,0 x 5,0 mm / straight		
	73-0816-25	73-0816-35		73-0894-45	73-0894-55
gerade, gezahnt, oval 3,5 mm / straight, serrated			gerade, 4,0 x 8,0 mm / straight		
				73-0886-45	73-0886-55
			gerade, gezahnt / straight, serrated		
				73-0850-45	73-0850-55
			gerade / straight		

Broncho-Ösophagoskopiezangen Bronchoesophagocopy-forceps

Broncho-Ösophagoskopiezangen
Maulteil doppelbeweglich, Schaft aufgelegt
Bronchoesophagocopy-forceps, both mouths movable, shaft superposed



Nutzlänge usable length	350 mm	450 mm	550 mm
----------------------------	--------	--------	--------

Hechtmaul grasping forceps	73-0410-35	73-0410-45	73-0410-55
-------------------------------	------------	------------	------------



Alligator alligator forceps	73-0412-35	73-0412-45	73-0412-55
--------------------------------	------------	------------	------------



Doppel- koffel rund bipolar forceps	73-0414-35	73-0414-45	73-0414-55
--	------------	------------	------------

Broncho-Ösophagoskopiezangen
Maulteil doppelbeweglich, Rohrschaft
Bronchoesophagocopy-forceps, both mouths movable, canal shaft



Nutzlänge usable length	350 mm	450 mm	550 mm
----------------------------	--------	--------	--------

Hechtmaul grasping forceps	73-0450-35	73-0450-45	73-0450-55
-------------------------------	------------	------------	------------



Alligator alligator forceps	73-0452-35	73-0452-45	73-0452-55
--------------------------------	------------	------------	------------



Doppel- koffel oval bipolar forceps	73-0454-35	73-0454-45	73-0454-55
--	------------	------------	------------



Anästhesie
Anaesthesia



Laryngoskope nach McIntosh englisches Modell

McIntosh laryngoscope

Vorteile:

1. Spatel und Kontakte aus rostfreiem Edelstahl, daher verschleißarm
2. Bis 180° C sterilisierbar
3. Maximale Ausnutzung der Lichtquelle
4. Anschluß nach International Standard ISO 7376/1

Advantages:

1. Blades and contacts of stainless steel, therefore wear-resistant
2. Can be sterilized up to 180° C
3. Optimal exploitation of light-source
4. Measure of connection according to international ISO 7373/1

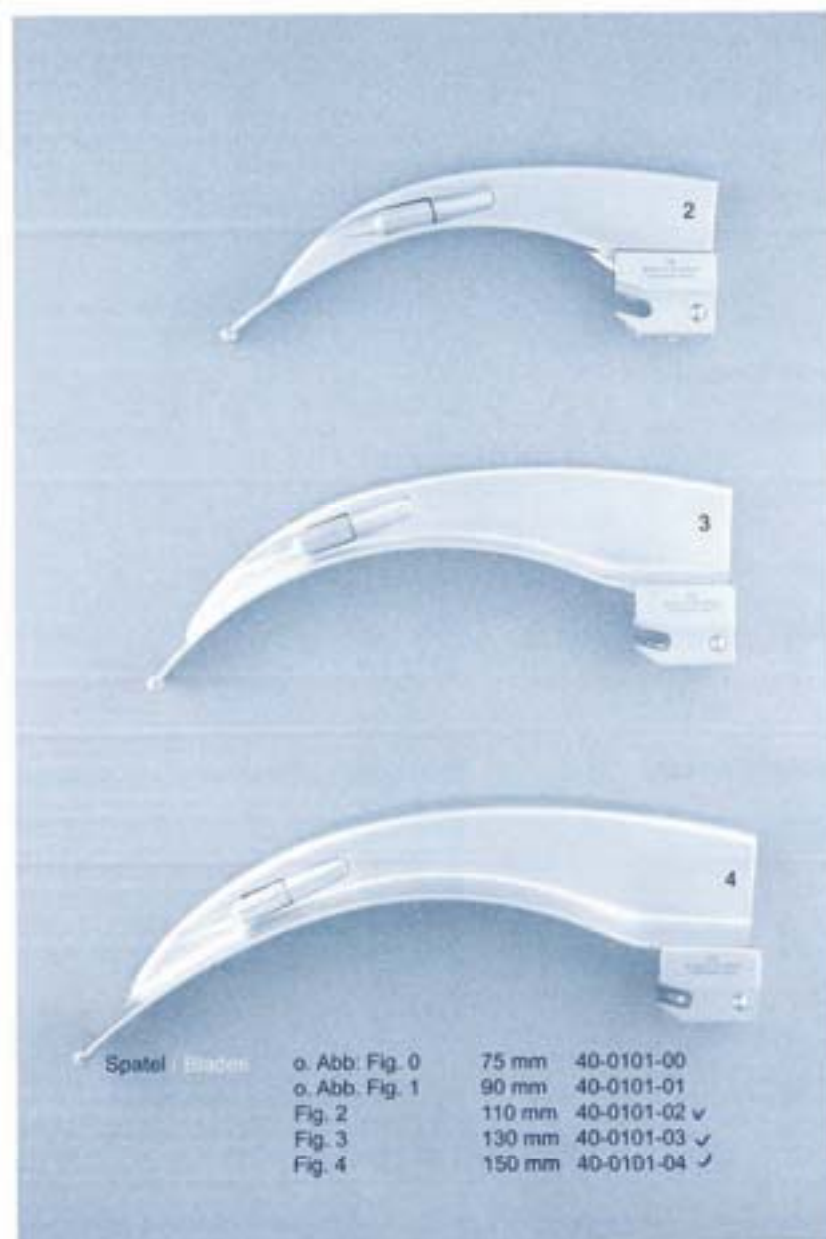

Spatel / Blades

o. Abb. Fig. 0	75 mm	40-0101-00
o. Abb. Fig. 1	90 mm	40-0101-01
Fig. 2	110 mm	40-0101-02 ✓
Fig. 3	130 mm	40-0101-03 ✓
Fig. 4	150 mm	40-0101-04 ✓



Griff aus rostfreiem Edelstahl
(ohne Batterien)
handles made of stainless steel
(without batteries)
40-0101-10

o. Abb.: Ersatzbirne für Fig. 0
2,5 V - 300 mA
spare bulb for fig. 0
40-0101-122

o. Abb.: Ersatzbirne für Fig. 1 - 4
2,5 V - 300 mA
spare bulb for fig. 1 - 4
40-0101-123

Laryngoskope nach McIntosh Fiber - Optik - Spatel
 englisches Modell - Lichtleiter verdeckt
 McIntosh model - internal light conductor Laryngoscopes

Anschluß nach Deutscher Norm DIN 58870 mit grünem Punkt
 Measure of connection according to German Standard DIN
 58870 with green point

Spatel / blades
 (passend zu Griff 40-0101-12 / fitting handles 40-0101-12)

o. Abb.: Fig. 0	75 mm	40-0101-50
Fig. 1	90 mm	40-0101-51
Fig. 3	110 mm	40-0101-52
Fig. 4	130 mm	40-0101-53
Fig. 5	150 mm	40-0101-54



Laryngoskope nach Miller - Fiber - Optik - Spatel

Miller - Fiberoptic Laryngoscopes

Anschluß nach Deutscher Norm DIN 58870 mit grünem Punkt

Measure of connection according to German Standard DIN 58870 with green point

Spatel / blades

(passend zu Griff 40-0101-12 / fitting handles 40-0101-12)

Fig. 0	75 mm	40-0101-60
Fig. 1	100 mm	40-0101-61
Fig. 2	155 mm	40-0101-62
Fig. 3	195 mm	40-0101-63
Fig. 4	205 mm	40-0101-64



Mundsperrer nach Roser-König 160 mm
 Roser-König Mouth gag
 40-0048-00



Mundsperrer nach Heister 130 mm
 Heister Mouth gag
 40-0030-00



Zungenzange nach Young 160 mm
 Young Tongue Holding
 Forceps
 40-0004-00

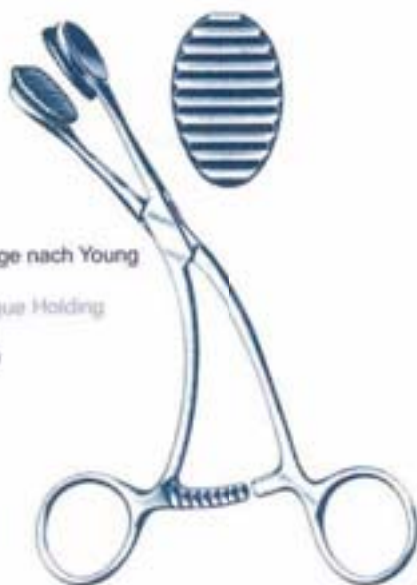

Zungenzange nach Collin 160 mm
 Collin Tongue Holding
 Forceps
 40-0001-00

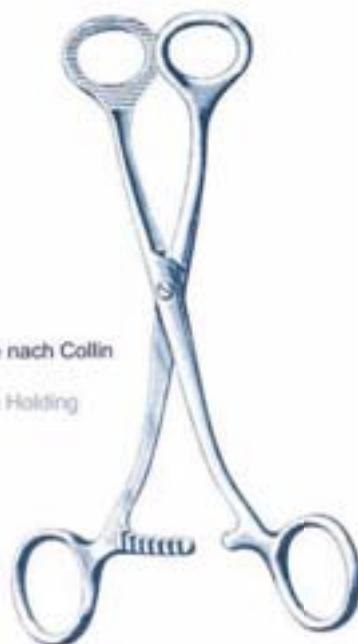

Kathetereinführungen nach Magill
Magill Catheter Introducing Forceps

1	für Frühgeborene for premature	170 mm	40-0240-00
2	für Kinder for children	200 mm	40-0230-00
3	für Erwachsene for adults	250 mm	40-0220-00

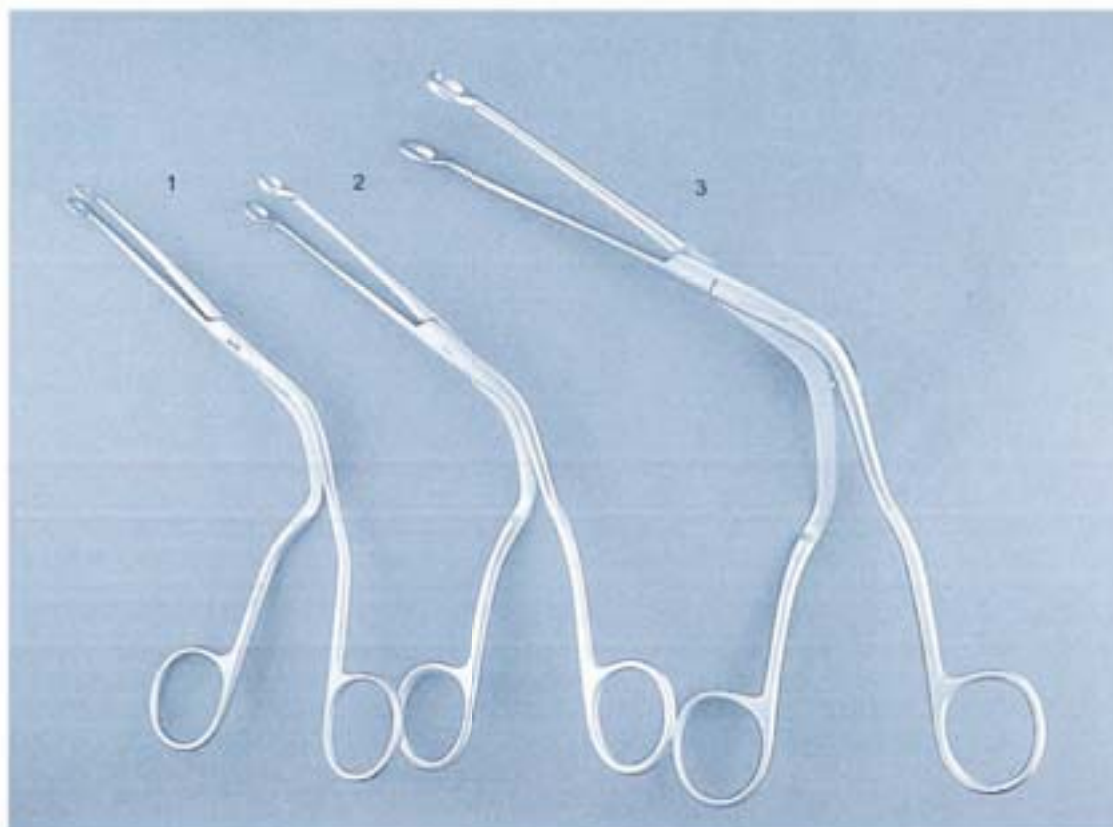

Elektrochirurgie
Electrosurgery



Instrumenten-Sets
Instrument-Sets

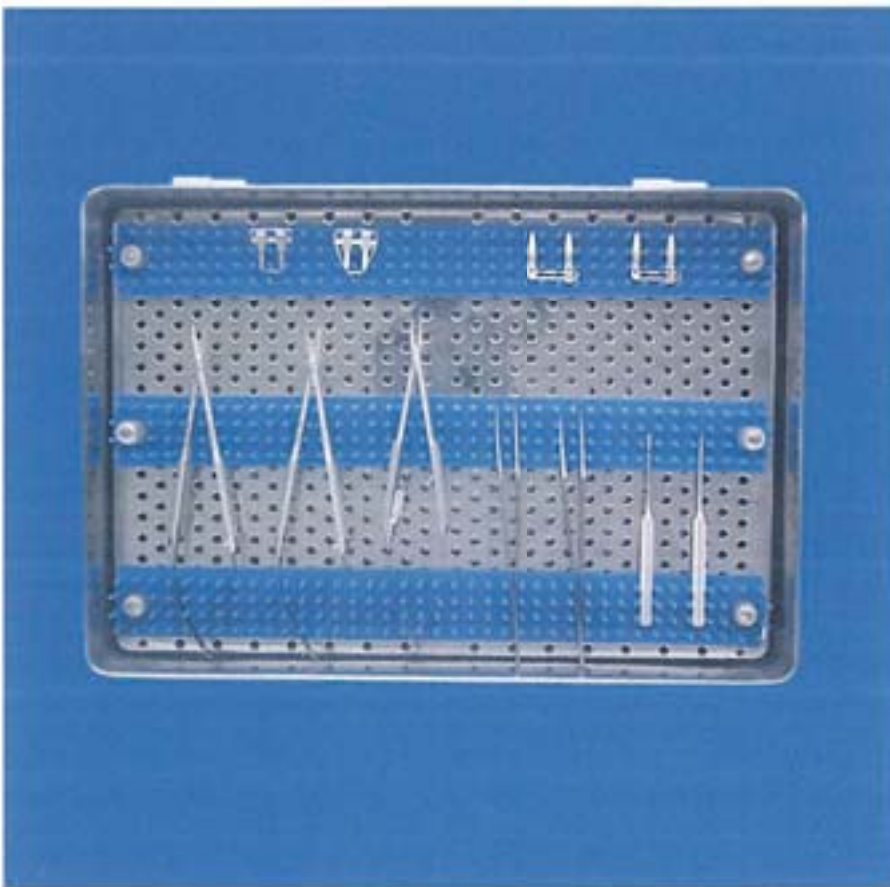

Behälter
Container





Watte- und Tupferbehälter

Cotton- and sponge container

ø mm	Höhe height	Behälter container	Deckel cover
60	60	87-1541-00	87-1541-01
85	85	87-1542-00	87-1542-01
85	50	87-1543-00	87-1542-01
100	100	87-1544-00	87-1543-01
100	50	87-1545-00	87-1543-01
120	120	87-1546-00	87-1544-01
150	150	87-1547-00	87-1545-01
150	100	87-1548-00	87-1545-01
200	200	87-1549-00	87-1546-01
200	100	87-1550-00	87-1546-01



Lösungsschalen / lotionbowl

ø mm	Höhe / height	
40	19	87-1571-00
60	30	87-1572-00
85	40	87-1573-00
110	55	87-1574-00
150	75	87-1575-00
210	90	87-1576-00



Zangenbehälter

Forceps holder

ø mm	Höhe / height	
30	90	87-1531-00
50	100	87-1532-00
50	130	87-1533-00
50	180	87-1534-00
82	130	87-1535-00
82	180	87-1536-00
95	200	87-1538-00

Lösungsschalen / lotionbowl

ø mm	Höhe / height	
50	45	87-1582-00
60	52	87-1583-00
80	35	87-1521-00
90	55	87-1522-00
100	65	87-1523-00
120	70	87-1524-00



Nadeldosen / needle case

ø mm	Höhe height	
65	17	87-1585-00
62	15	87-1586-00





Wattespender
Dispenser for
cotton-wool

81-0471-08



Instrumentenschale mit Deckel
Instrument tray with lid

Länge	Breite	Höhe (mm)	
Length	Width	Height (mm)	

100	60	40	87-5151-00
120	80	40	87-5152-00
160	100	30	87-5153-00
180	120	50	87-5154-00
200	100	50	87-5155-00
220	150	50	87-5156-00
260	150	50	87-5157-00
300	200	50	87-5158-00
400	200	80	87-5159-00
450	110	50	87-5161-00
500	270	70	87-5162-00



Medizinbecher
graduier
measure graduated

30 ml	87-1580-00
50 ml	87-1581-00



Meßbecher measure

10 cl	87-5493-00
25 cl	87-5495-00



Nierenschalen, Metall
kidney dish, steel

170 mm	87-0211-00
250 mm	87-0212-00

Kunststoff weiß
plastic, white

260 mm 87-2012-00

Steril-Container-System Aseptic container system

Versorgungscontainer

Steril-container-system for sterile supply

	mit Deckel und Bodenlochung lid and bottom perforated	Deckel gelocht Boden ungelocht lid and bottom not perforated
600 x 290 x 250 mm	91-0500-50	91-0501-50
600 x 290 x 170 mm	91-0500-70	91-0501-70
600 x 290 x 130 mm	91-0500-30	91-0501-30
600 x 290 x 100 mm	91-0500-00	91-0501-00
300 x 290 x 250 mm	91-0499-50	91-0488-50
300 x 290 x 170 mm	91-0499-70	91-0488-70
300 x 290 x 130 mm	91-0499-30	91-0488-30
300 x 290 x 100 mm	91-0499-00	91-0488-00

Entsorgungscontainer mit Deckel und Bodenlochung

container return to the supply department, lid and bottom perforated

600 x 290 x 250 mm	91-0500-25
600 x 290 x 170 mm	91-0500-17
600 x 290 x 130 mm	91-0500-13
600 x 290 x 100 mm	91-0500-10
300 x 290 x 250 mm	91-0499-25
300 x 290 x 170 mm	91-0499-17
300 x 290 x 130 mm	91-0499-13
300 x 290 x 100 mm	91-0499-10

Einsatzsiebe aus Edelstahl-Drahtgeflecht

trays of stainless steel wire mesh

480 x 258 x 50 mm	91-0715-00
240 x 258 x 50 mm	91-0716-00

Einsatzsiebe aus Edelstahl-Lochblech

trays of perforated stainless steel sheet

480 x 265 x 50 mm	91-0706-00
240 x 258 x 50 mm	91-0708-00



Sterilisierkassetten
Sterilisation cases

**Deckel und Boden
Lochung mit Textilfilter**
bottom and cover
perforated
with textile filter

**Bodenlochung
Deckel ungelocht
Metall-Dauerfilter**
bottom and cover
perforated
with wire gauze
filter

mit Silikon Noppenstreifen
with silicone knotting strips

200 x 140 x 50 mm 91-0456-50
400 x 100 x 50 mm 91-0456-80
400 x 150 x 50 mm 91-0456-30

91-0570-50
91-0570-80
91-0570-30

mit Silikon Noppenbank
with silicone knotting bank

200 x 140 x 50 mm 91-0456-52
400 x 100 x 50 mm 91-0456-82
400 x 150 x 50 mm 91-0456-31

91-0570-52
91-0570-82
91-0570-31



Behälter



Sonstiges
Miscellaneous

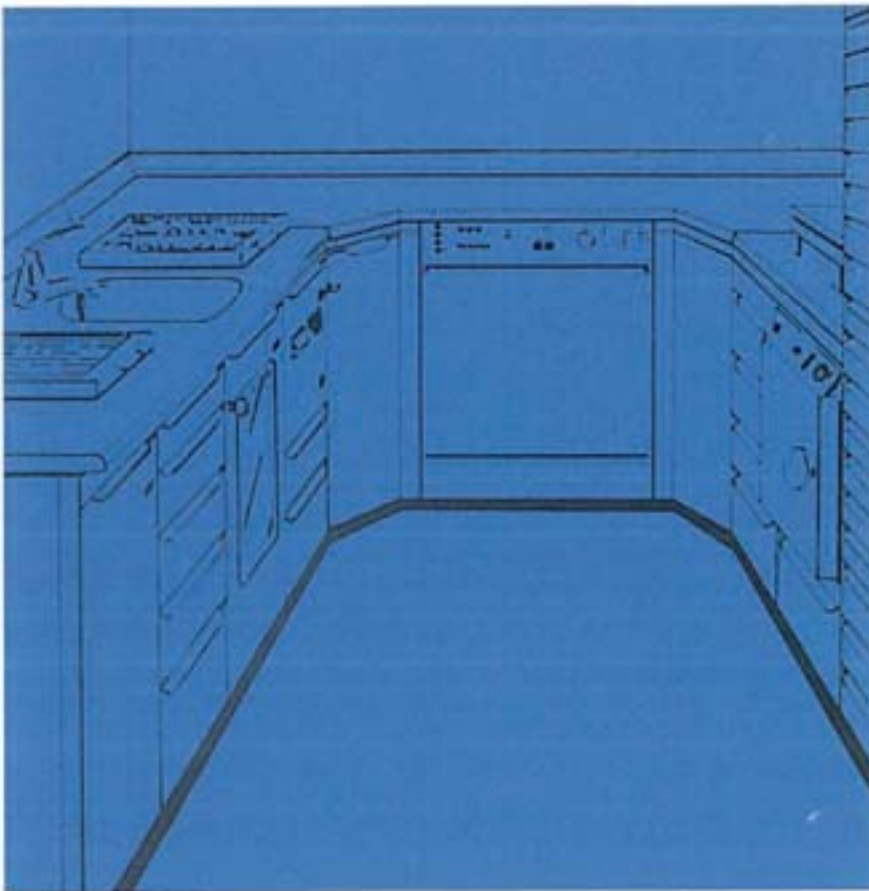

Service



Laser signing device Scriptograph
laser signatur:

- fast
- safe
- accurate
- permanent

We laser for you article-number on instruments, containers or signs, we produce type plates, character marks with our Yag-laser system.

Materials: steel, aluminium, aluminium-anodized, brass, gold or gold-plated metals, silver oder silver-plated metals, chromium-plated metals, synthetic materials, poly carbonate

Delivery: short-term, in due time, punctually
We skillfully repair for you surgical instruments.
Use our fetch service and bring service.*

Laser Signiergerät Scriptograph

Wir lasern Ihnen die Artikel-Nr. wieder auf Ihre Instrumente, Behälter oder Schilder. Wir fertigen Typenschilder, Kennzeichnungsmarken mit unserer Yag-Laser - Beschriftungsanlage.

Lasersignieren:

- schnell
- sicher
- sauber
- dauerhaft

Materialien: Stahl, Aluminium, Aluminium-Eloxier, Messing, Gold oder vergoldet, Silber oder versilbert, verchromte Teile, Kunststoff, Polycarbonat.

Termin: kurzfristig, termingerecht, pünktlich

Wir reparieren für Sie fachgerecht chirurgische Instrumente.

Nutzen Sie unseren Hol- und Bringservice.



- 1 Praxissauger "fidato"
mit 0,5 l Sekretglas,
Saugleistung: 22 l/Min.
71-0085-00

Practice suction apparatus "fidato"
0,5 l secretary glass,
suction performance: 22 l/Min.
71-0085-00



- 2 Tray für Instrumente
284 x 184 mm
ohne Instrumentenhalter
88-505.0516.0

tray for instruments
284 x 184 mm
without rack for instruments
88-505.0516.0



- 2 Gezahnter Instrumenten-
halter groß
88-508.0566.0

Serrated rack for instruments
large
88-508.0566.0



- 2 Tray für Instrumente
184 x 142 mm
ohne Instrumentenhalter
88-508.0058.0
Gezahnter Instrumentenhalter
klein
88-508.0567.0

Tray for instruments
184 x 142 mm
without rack for instruments
88-508.0058.0
Serrated rack for instruments
small
88-508.0567.0



- 3 Spender für Watte oder
Zungenlappchen
81-0471-00

Dispenser for cotton-wool or
tongue patches
81-0471-00



- 4 Spender für Watte und
Zungenlappchen
88-506.1540.0

Dispenser for cotton-wool and
tongue patches
88-506.1540.0



- 5 Kasten zur Geruchs- und
Geschmacksprüfung
(Inhalt lt. individueller
Verordnung)
99-2500-00

Case for testing the sense of smell
and taste
(contents according to individual
prescription)
99-2500-00

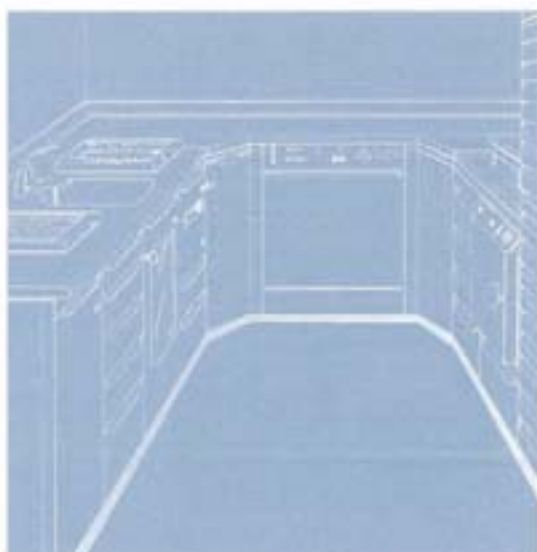

MIELE Thermodesinfektoren
Beratung und Angebot auf Anfrage
Advice and quotation on request.

Reinigungs - Pistole
mit Tischrosette komplett,
zum Einbau in eine Tischplatte,
für die Reinigung von Hohlräumen
91-8010-02

Cleaning pistol
complete with table rosette,
for installation into a table top
for cleaning hollow bodies
91-8010-02



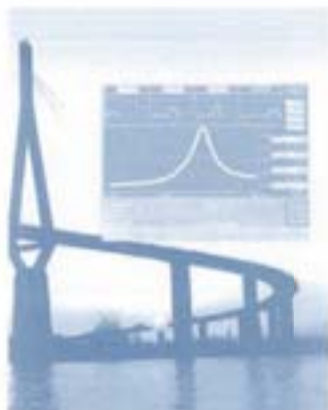

HMOETH HNO Therapieplätze
Beratung und Angebot auf Anfrage

TEUTOTECHNIK Notfallkoffer
Beratung und Angebot auf Anfrage

SCHUMACHER & PARTNER Inhalierplätze
Beratung und Angebot auf Anfrage

RADARMED Mikrowellentherapiegeräte
Beratung und Angebot auf Anfrage



HMOETH HNO therapy places
Advice and quotation on request

TEUTOTECHNIK, emergency bag
Advice and quotation on request

SCHUMACHER & PARTNER inhalation places
Advice and quotation on request

RADARMED Microwave therapy unit
Advice and quotation on request



**DANTSCHKE HNO - Arbeitsplätze
Beratung und Angebot auf Anfrage**

DANTSCHKE ENT workplaces
Advice and quotation on request



KAPS Untersuchungs- und OP - Mikroskope
Beratung und Angebot auf Anfrage

KAPS examination microscope and surgical microscope
Advice and quotation on request



**ZEISS Untersuchungsmikroskope
Beratung und Angebot auf Anfrage**

ZEISS examination microscopes
Advice and quotation on request

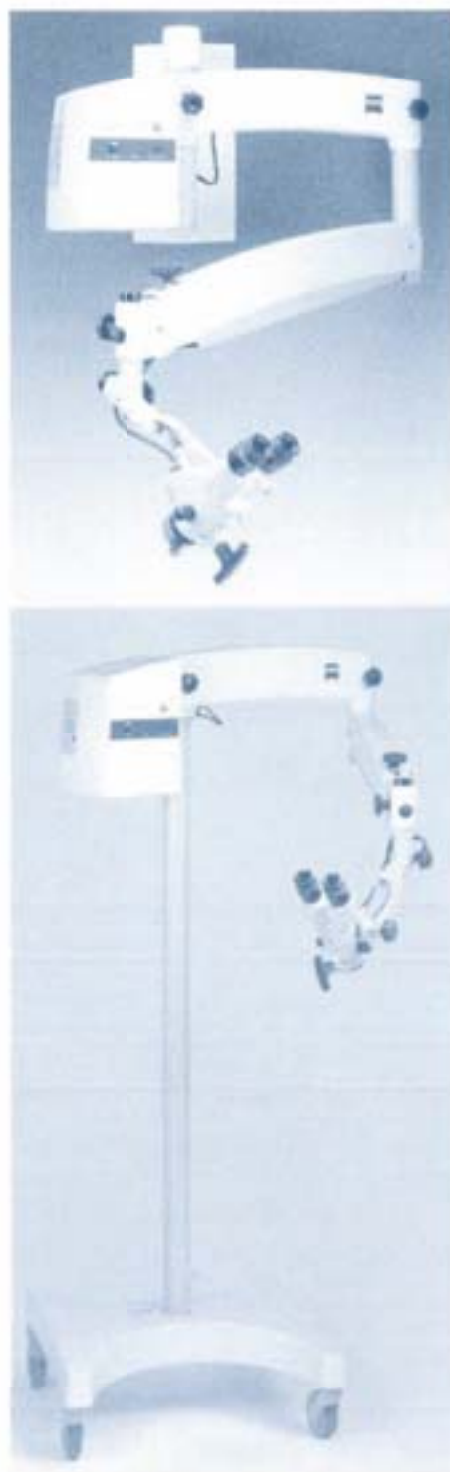



Sonstiges